



ABB i-bus[®] KNX KNX/EnOcean Gateway Product Manual

EG/A 32.2.1

KNX/EnOcean Gateway

Application's Program Version: 2.6
Plugin's Version: 1.0.0.13

User's Manual

Issue Date: 06/2014
r1.5 eng



Gateway for integration of EnOcean devices into KNX TP-1 (EIB) control systems and vice versa.

Important:

The KNX/EnOcean Gateway sends its data within the 868 frequency band which is approved for EnOcean in the European Union incl. Switzerland, Turkey & Norway.

Further details can be found in the EnOcean Radio Approval Overview (see external [link](#)).

Please ensure that the product is suitable for application in the intended country of final installation and use before purchase.

Order Codes: **KNX/EnOcean Gateway 2CDG 120 047 R0011**

INDEX

- 1 Presentation 5
- 2 Quick Setup..... 6
- 3 Integration examples 7
 - 3.1 EnOcean AC integration – Plugin integration 7
 - 3.2 Light actuator integration – Simulated EnOcean device (RPS) 8
 - 3.3 Window contact integration – Button usage example 9
 - 3.4 Room Operating Panel integration – Discover function 10
- 4 Connection 12
 - 4.1 Connection of the interface to the KNX bus 12
 - 4.2 Connection of the EnOcean interface 12
 - 4.2.1 Placement..... 12
 - 4.2.2 Screening zones 13
 - 4.2.3 Penetration Angle 13
 - 4.2.4 Distance between receiver and sources of interference 13
- 5 KNX/EnOcean Gateway plugin for ETS..... 14
 - 5.1 Gateway mapping view..... 15
 - 5.1.1 Adding / Erasing EnOcean devices from ETS 18
 - 5.1.2 General device settings 20
 - 5.1.3 Communication objects parameters 20
 - 5.1.4 Enable and disable communication objects 21
 - 5.1.5 Add a new catalogue 22
 - 5.2 Remote EnOcean Teach-in/Learning..... 23
- 6 Device programming and monitoring buttons..... 27
 - 6.1 Learn/Teach-in EnOcean devices 27
 - 6.2 Erase EnOcean devices 28
 - 6.2.1 Erase current integrated device. 28
 - 6.2.2 Erase all devices in a Device Node 28
 - 6.3 Monitor mode..... 29
 - 6.4 Programming KNX physical address 29
- 7 Technical Specifications 30
- 8 Appendix A – EnOcean Family Communication Objects Tables 31
 - 8.1 AC interface..... 31
 - 8.2 Digital Input..... 34
 - 8.3 Central Controllers: Lights, blinds and temperature 35
 - 8.4 Gas and Particles Sensor 37
 - 8.5 Temperature sensor 37

8.6	Heating actuators	38
8.7	Humidity Sensors.....	40
8.8	Light Sensors.....	41
8.9	Metering	42
8.10	Occupancy Sensors.....	43
8.11	Window and Door Sensors	43
8.12	Rocker Switch and Key Card	44
8.13	Room Operating Panel	44
9	Appendix A – EnOcean interoperability (EEP)	47
9.1	ABB supported EEPs.....	47
10	Appendix B - KNX/EnOcean Gateway HMI	48

1 Presentation



The ABB KNX/EnOcean Gateway allows a complete and natural integration of EnOcean devices into KNX control systems and vice versa.

Main features:

- Reduced dimensions.
- Quick and easy installation.
- External power not required. Supplied through the KNX bus.
- Fully bidirectional.
- Supporting up to 253 KNX communication objects.
- Up to 32 simultaneous channels (or device nodes) and up to 5 devices (internal or linked) per channel.
- Fast and easy integration with ABB EnOcean Gateways for air conditioning.
- Easy way to add new EnOcean devices through our catalogue file.
- Internal LCD to setup/monitor EnOcean devices.
- EnOcean devices quality signal reception shown in the gateway LCD.
- Intuitive and easy setup thanks to the ETS plugin with no need of any external software.
- Multiple objects for control and status (bit, byte, characters...) with KNX standard datapoint types.
- Status objects for every control available.

2 Quick Setup

1. Import the Product ABB KNX/EnOcean Gateway EG/A 32.2.1 in the ETS.
2. Add the Gateway to your ETS Project.
3. Connect the Gateway to the KNX Bus.
4. Program with the ETS the physical address and the empty Application program, of the Gateway.
Thereby the file of the available EnOcean devices (*.ike) will be loaded into the gateway, Details see section 4
5. Open the gateway parameters in the ETS.
6. Click the button "Add Device Node".
7. In the following window, click on the button "Discover Device".
 - a) Wait until the progress bar „Discovering devices (press Teach button)“ appears at the left bottom of the window.
 - b) Push the Teach button on the EnOcean Device you want to connect.
The Progress bar disappears and the appropriate device data fades in.
 - c) By pushing the button „Add Device Node“ the device gets integrated.

For every following EnOcean device repeat steps 5 and 6.

With this approach for setup only the standard communication objects will be visible/active in the ETS. If you need other communication objects or want to modify the standard communication objects you can do this with the ETS plugin. For details see section 5.

8. In the ETS you can now connect the communication objects of the EnOcean devices to your group addresses.
9. Download the application program to the Gateway.
10. Place the EnOcean devices at their destination point and test their functionality (signal strength)
You can use the i-bus Tool (www.abb.com/knx) for testing of the function and the signal strength.

Recommendation:

With a radius of 5m around the gateway the EnOcean devices should be certainly discovered.

At a signal strength < -80 dBm (< 30% signal strength) you have to connect the device to an additional gateway.

3 Integration examples

In order to show how you can use our gateway with EnOcean products and how they can be monitored and controlled through KNX, or vice versa (from KNX to EnOcean), next you have different examples showing different integration scenarios.

3.1 EnOcean AC integration – Plugin integration

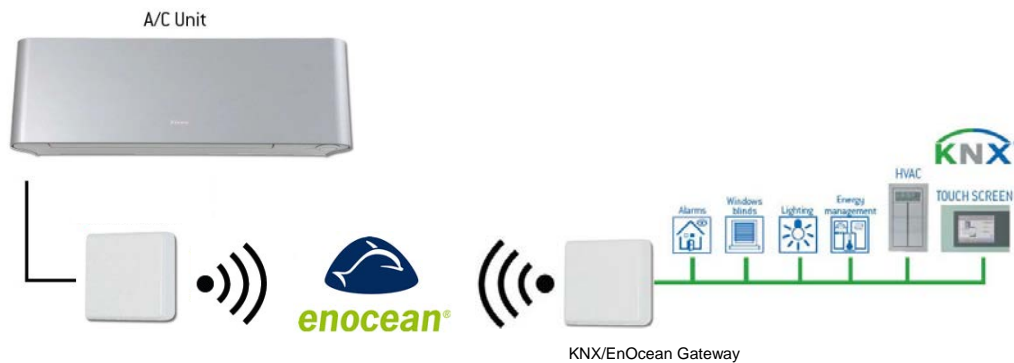

Figure 3.1 KNX/EnOcean Gateway and EnOcean Air Conditioner integration example

Next, there is a step by step example on how to integrate EnOcean AC interfaces into KNX through our gateway.

1. Connect KNX/EnOcean Gateway to the KNX bus and check EnOcean devices location. (see section 4.2)
2. Open the KNX/EnOcean Gateway plugin in the ETS and click on the **Add Device Node** button.
 - a. Select the first option to integrate a physical EnOcean device (already selected by default).
 - b. Select “Air Conditioner Interfaces” in the family device list.
 - c. Select the AC interface that you want to integrate and control from KNX.
 - d. Click on **Add Device Node** button (the window will be closed).
3. Select the communication objects to be used in the node tree and other parameters in the **Gateway mapping** tab. This step can be omitted if working with the default objects and parameters.
4. Move to the **Remote EnOcean Teach-in/Learning** tab.
 - a. Click on the **Download Parameters** button (a message window will pop-up indicating process progress).
 - b. Push the arrow in the **Learn** column.
 - c. In the EnOcean AC interface (Third party manufacture product), set profile F using the rotary switch and press the teach-in button (PB1).

- d. Press the **Download chip IDs** button to download the chip ID information into the KNX/EnOcean Gateway.
5. Close the plugin (all changes will be saved).
6. Use ETS to setup proper KNX group addresses for each communication object and also a proper KNX physical address for KNX/EnOcean Gateway.
7. Download current KNX configuration to the gateway as with any other KNX product.
8. EnOcean AC interface and the KNX/EnOcean Gateway are linked and ready to be used.

3.2 Light actuator integration – Simulated EnOcean device (RPS)



Figure 3.2 KNX/EnOcean Gateway and light actuator integration example

Below there is an example on how to integrate an EnOcean light actuator controlled into KNX through our gateway.

1. Connect KNX/EnOcean Gateway to the KNX bus and check EnOcean devices location.
2. Open the KNX/EnOcean Gateway plugin in the ETS and click on the **Add Device Node** button.
 - a. Select the second option to simulate an EnOcean device.
 - b. Select “Rocker Switch & Key Card” in the family device list.
 - c. Select the “2-button Rocker – Light and Blind Control”.
 - d. Click on **Add Device Node** button (the window will be closed).
3. Select the communication objects to be used in the node tree and other parameters in the **Gateway mapping** tab. This step can be omitted if working with the default objects and parameters.
4. Move to the **Remote EnOcean Teach-in/Learning** tab.
 - a. Click on the **Download Parameters** button (a message window will pop-up indicating process progress).
 - b. Push the arrow in the **Learn** column (a pop-up window will appear).

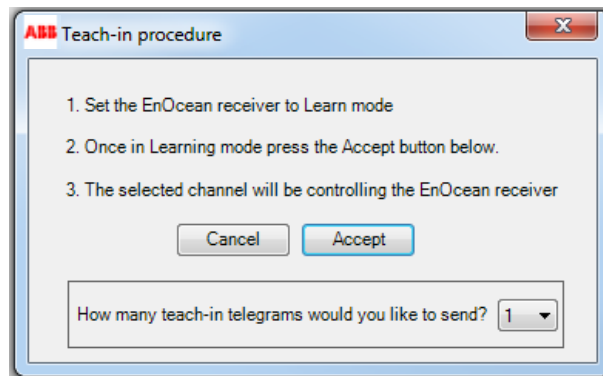

Figure 3.3 Teach-in process for rocker with multiple teach-in telegrams

- c. Select the number of telegrams the EnOcean light actuator needs to be Teach-in. Check your EnOcean device manual for more information.
 - d. Set the EnOcean device you want to use in learning mode.
 - e. Press the **Accept** button. The selected number of telegrams in the dropdown menu will be sent to the EnOcean device.
5. Close the plugin (all changes will be saved).
 6. Use ETS to setup proper KNX group addresses for each communication object and also proper KNX physical address for KNX/EnOcean Gateway.
 7. Download current KNX configuration to the gateway as with any other KNX product.
 8. The EnOcean device (the light actuator in this case) and the KNX/EnOcean Gateway are linked and ready to be used together with the KNX installation.

3.3 Window contact integration – Button usage example



Figure 3.4 KNX/EnOcean Gateway and Window Contact integration example

In order to see an example, we are going to proceed with the integration of an EnOcean Window contact. In this case, chipID information is set up using the gateway buttons and not the plugin.

1. Connect KNX/EnOcean Gateway to the KNX bus and check EnOcean devices location.
2. Open the KNX/EnOcean Gateway plugin in the ETS and click on the **Add Device Node** button.

- a. Select the first option to integrate a physical EnOcean device (already selected by default).
 - b. Select “Window and Door Sensor” in the family device list.
 - c. Select the “Window Contact” in the device list.
 - d. Click on **Add Device Node** button (the window will be closed).
3. Select the communication objects to be used in the node tree and other parameters in the **Gateway mapping** tab. This step can be omitted if working with the default objects and parameters.
 4. Move to the **Remote EnOcean Teach-in/Learning** tab.
 - a. Click on the **Download Parameters** button (a message window will pop-up indicating process progress).
 5. Close the plugin (changes will be saved automatically).
 6. Use ETS to setup proper KNX group addresses for each communication object and also proper KNX physical address for KNX/EnOcean Gateway.
 7. Download current KNX configuration to the gateway as with any other KNX product.
 8. Use the Up/Down arrows in the KNX/EnOcean Gateway to get to the Node where the device is placed in. Finally you only have to link the EnOcean Window Contact by pressing the KNX/EnOcean Gateway Learn/Teach-in button (an “L” appear in the LCD) and pressing the Teach-in button in the Window Contact (labeled as LRN in some devices).
 9. The EnOcean device (the windows contact in this case) and the KNX/EnOcean Gateway are linked and ready to be used together with the KNX installation.

3.4 Room Operating Panel integration – Discover function



Figure 3.5 KNX/EnOcean Gateway and Rocker integration example

In this example, we are going to proceed with the integration of an EnOcean Room Operating Panel. In this case, device type selection and chipID information is stored automatically.

1. Connect KNX/EnOcean Gateway to the KNX bus and check EnOcean devices location.
2. Open the KNX/EnOcean Gateway plugin in the ETS and click on the **Add Device Node** button.

- a. Select the first option to integrate a physical EnOcean device (already selected by default).
 - b. Check the *Add Chip Id automatically* check box.
 - c. Click on **Discover Device** button.
 - d. Press the Teach-in/Learn button of the Room Operating Panel. Device family and EnOcean device will be selected automatically.
 - e. Click on **Add Device Node** button (the window will be closed).
3. Select the communication objects to be used in the node tree and other parameters in the **Gateway mapping** tab. This step can be omitted if working with the default objects and parameters.
 4. Move to the **Remote EnOcean Teach-in/Learning** tab.
 - a. Click on the **Download Parameters** button (a message window will pop-up indicating process progress).
 5. Close the plugin (changes will be saved automatically).
 6. Use ETS to setup proper KNX group addresses for each communication object and also proper KNX physical address for KNX/EnOcean Gateway.
 7. Download current KNX configuration to the gateway as with any other KNX product.
 8. The EnOcean device (the Room Operating Panel in this case) and the KNX/EnOcean Gateway are linked and ready to be used together with the KNX installation.

4 Connection

4.1 Connection of the interface to the KNX bus

Disconnect power of the KNX bus. Connect the interface to the KNX TP-1 (EIB) bus using the KNX standard connector (red/grey) of the interface, respect polarity and then reconnect power of the KNX bus.

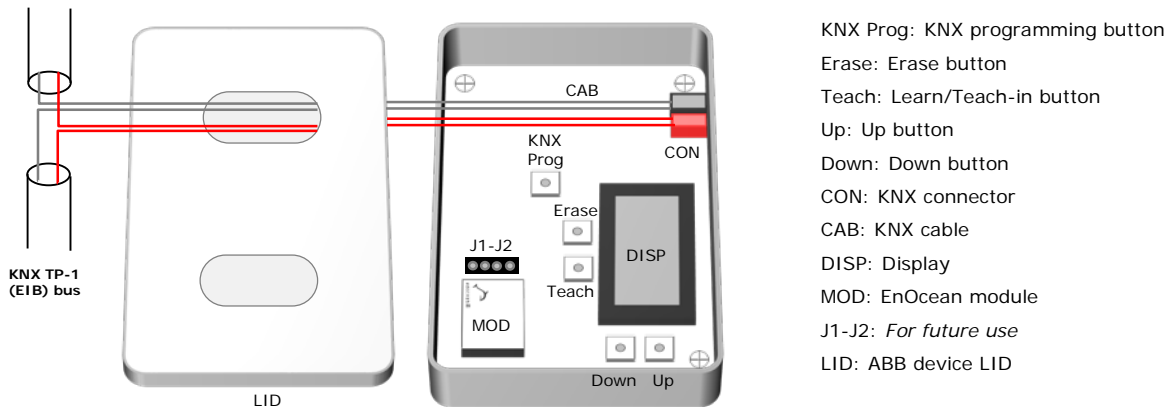

Figure 4.1 Device description and connection to KNX bus

Then it will start an initialization process, KNX/EnOcean Gateway will be printed on the ABB device display for a few seconds (see the location of the display in Figure 4.1). The normal operation starts when display turns OFF.

It is important to bear in mind that changes made during the initialization process will not have effect until it finishes.

4.2 Connection of the EnOcean interface

EnOcean protocol runs in a wireless mode, so no wiring is needed during the connection stage. To connect EnOcean devices with the KNX/EnOcean Gateway EnOcean interface, please follow instructions in this manual and recommendation below.

4.2.1 Placement

The ABB interface antenna has a better sensibility when the device is placed vertically, and therefore this is the preferred position when placed (antenna zone should be located in the bottom side, floor side, once the device is fixed to the wall).

The coverage distance (see Table 4.1) of the signal emitted by the ABB, or by any other EnOcean device, is determined by the room geometry and where they are placed. As an example, long narrow corridors with wide walls are an adverse situation. People or other obstacles can reduce the coverage distance too. Therefore, is advised to always think in the worst possible scenario to decide the placement of the device to ensure a good stability in the radio system.

Coverage distance	Conditions
< 30 m	Under ideal conditions: broad room, no obstacles, good antenna design and good antenna positions.
< 20 m	The room is filled with furniture and people and penetration through up to 5 dry walls or up to 2 brick walls or up to 2 aero concrete walls.
< 10 m	Identical to the previous case but the receiver is placed to a room corner or range along a narrow floor.
< 1 m	Metal-reinforced ceilings at upright penetration angle (in strong dependence of reinforcement density and antenna positions).

Table 4.1 KNX/EnOcean Gateway coverage distance

4.2.2 Screening zones

It is important not to place the device in a place where the airwaves must go through a metallic object as they create a screening zone where the receivers are not going to be able to receive the EnOcean telegrams. This situation is shown in Figure 4.2a.

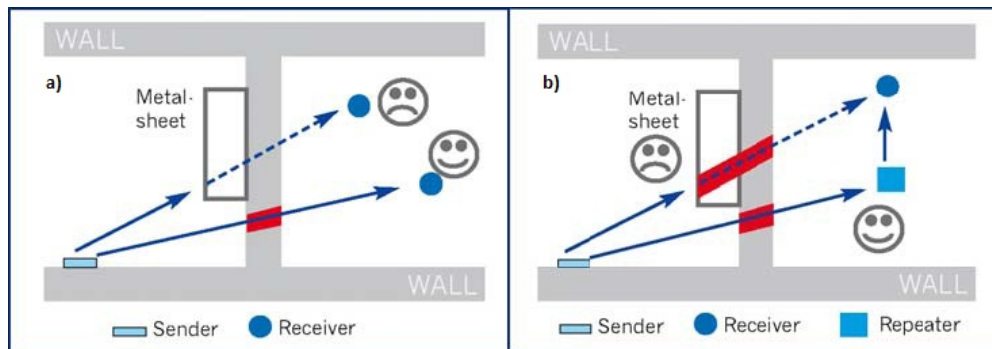

Figure 4.2 a) Screening zone b) Solution with a repeater

The situation of one of the receivers does not allow it to receive the transceiver telegrams. To solve this situation the use of an additional Gateway outside the screening zone (Figure 4.2b) is recommended.

4.2.3 Penetration Angle

This is the angle in which the airwaves reach a certain object they need to go through. The transmission to the other side of the object would be better as this angle gets closer to 90°, being this the best transmission situation.

In Figure 4.3a a receiver in a situation where the penetration angle is too close to 0° is shown. The solution to that problem can be seen in Figure 4.3b using a gateway in a different position.

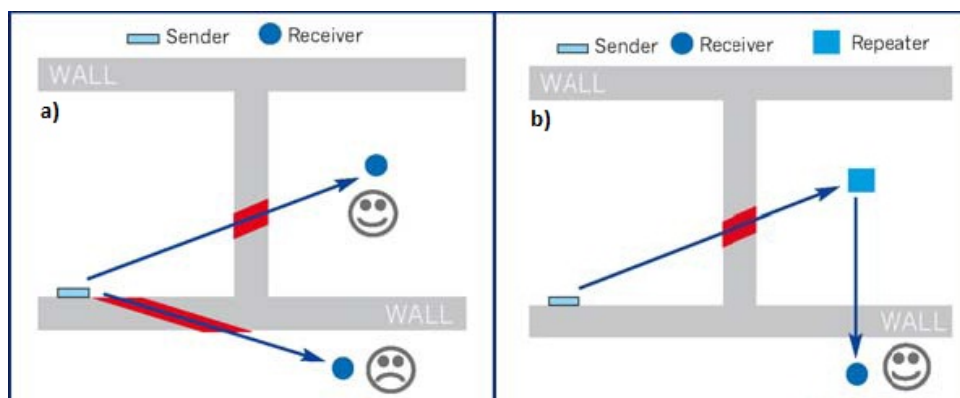

Figure 4.3 a) Penetration angle b) Solution with a repeater

4.2.4 Distance between receiver and sources of interference

The distance between EnOcean receivers, as it is the ABB and other transmitters (e.g. GSM / DECT / wireless LAN) or high frequency sources of interference (computers, audio and video equipment) should be higher than 50 centimeters.

However, EnOcean transmitters can be installed next to any other high-frequency transmitters without any problem.

5 KNX/EnOcean Gateway plugin for ETS

KNX/EnOcean Gateway is a fully compatible KNX device which must be configured and setup using standard KNX tool ETS and our specific plugin.

ETS product data for this device and the specific plugin can be downloaded from:

www.abb.com/knx

Once the database is imported, the plugin can be accessed when editing parameters. To get access to parameters edition you can right click on the gateway icon in the device tree (see Figure 5.1) and then select **Edit Parameters**. Another option would be to click on the **Parameters** tab, located in the project screen, and then pressing the specific parameter dialog (see Figure 5.2).

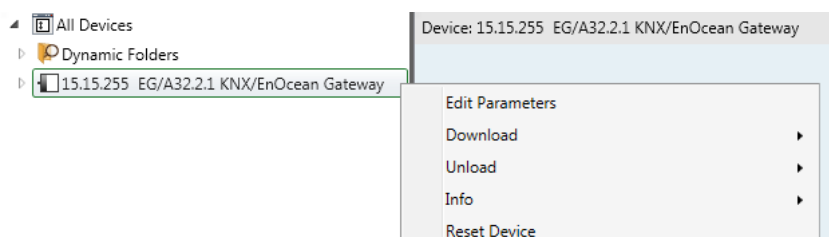

Figure 5.1 ETS Project managing screen

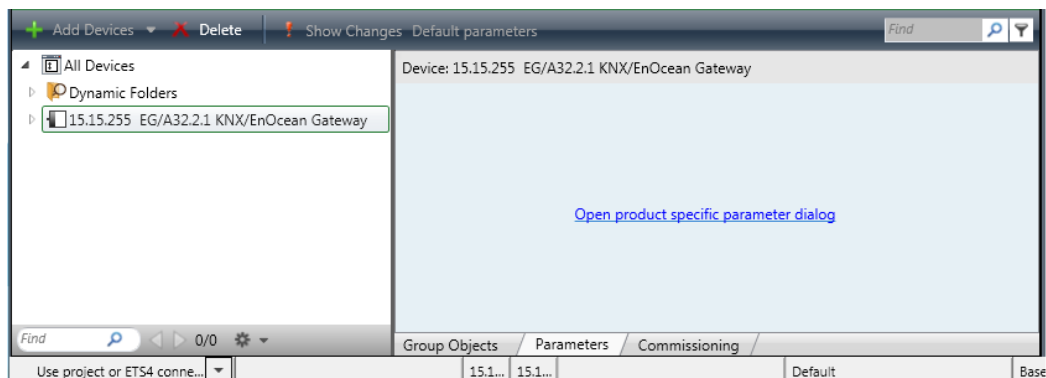

Figure 5.2 ETS Project managing screen

KNX/EnOcean Gateway plugin is divided in 2 main sections: Gateway mapping and Remote EnOcean Teach-in (see Figure 5.3). By default, users will be always directed to the Gateway mapping view.

5.1 Gateway mapping view

In this section, users will be able to add, erase and manage devices and their parameters. In Figure 5.3 different available options are shown.

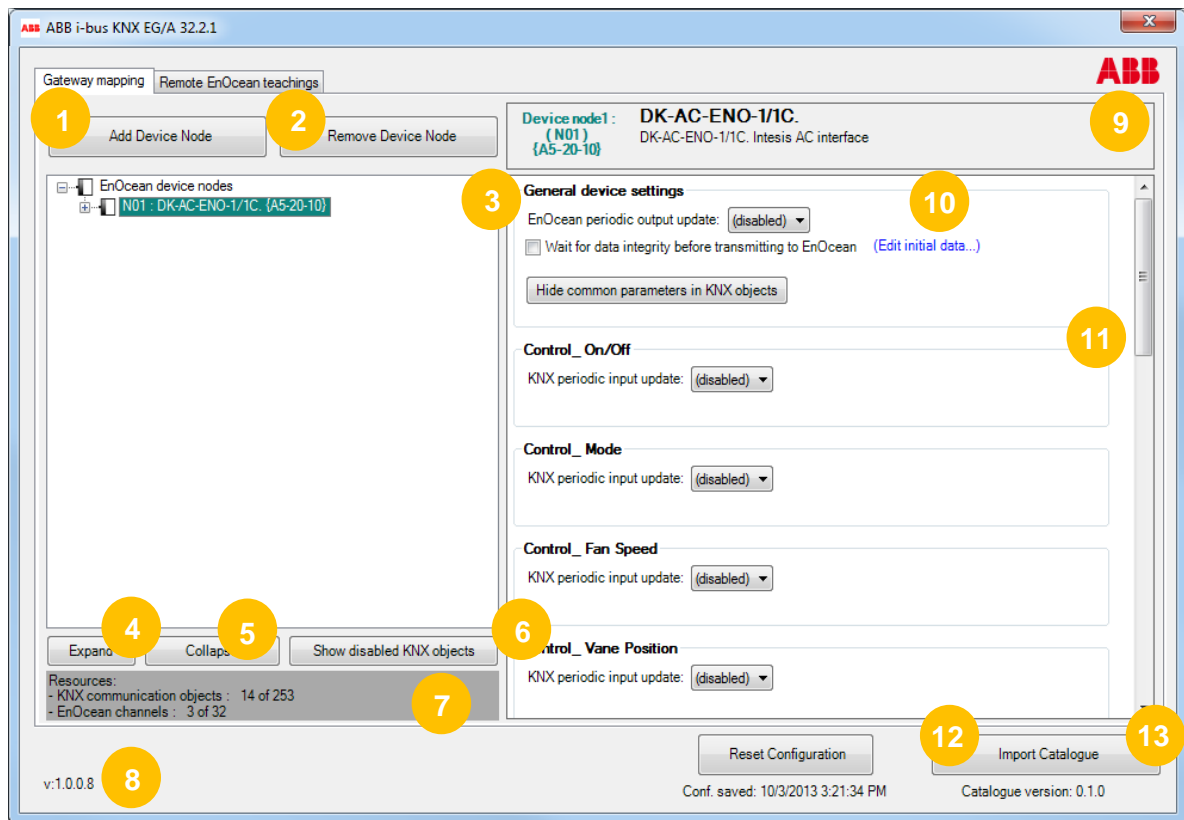

Figure 5.3 Plugin Gateway mapping screen

- 1 **Add Device Node:** Adds a new EnOcean device (in detail in section 0).
- 2 **Remove Device Node:** Removes an EnOcean device selected from the list (in detail in section 0).
- 3 **EnOcean device nodes list (Plugin-tree view):** List of EnOcean devices added and their communication objects. Communication objects can be enabled or disabled directly from this list (in detail in section 5.1.4)
- 4 **Expand:** Expands the list of devices and communication objects.
- 5 **Collapse:** Hides the list of devices and communication objects.
- 6 **Hide/Show disabled KNX objects:** Allows showing or hiding all the disabled objects. This is useful to easily see only all the enabled communication objects and manage them.

- 7 **Resources:** Provides information about free channels and communication objects available.
 - a. **KNX communication objects:** KNX communication objects used from total.
 - b. **EnOcean channels:** Channels used from total available. ¹
- 8 **Plugin version:** It indicates the current plugin version.
- 9 **EnOcean Device:** Name/type of the selected device (as it appears in the LCD screen).
- 10 **General device settings:** General parameters values of the integrated device. More details in section 5.1.2.

In case that the added device needs/has the option of setting some initial values, you can click on the **Edit initial data...** link. When clicking, new windows will pop-up showing editable parameters. In this same window, there is also a link to the EEP specification document, so field value specifications for each parameter can be found.

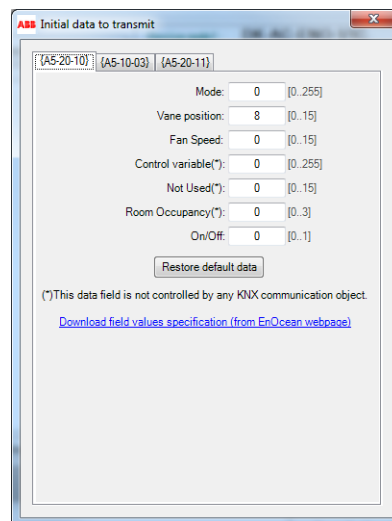

Figure 5.4 Initial data to transmit screen

- 11 **KNX communication objects settings:** List of editable parameters for enabled communication objects. More details about communication object settings can be found in section 5.1.3 .
- 12 **Reset configuration:** Resets current configuration erasing all nodes and communication objects in the project. Text below the button indicates when the last configuration was saved.
- 13 **Import catalogue:** Imports an IKE file with all available EnOcean devices. Text below the button indicates current catalogue version.

¹ All EnOcean devices occupy 1 channel except AC interfaces, which occupy 3 channels.

5.1.1 Adding / Erasing EnOcean devices from ETS

The **Add Device Node** button adds new EnOcean devices to be simulated or integrated into KNX. When clicking on the **Add Device Node** button, a new window pops-up (see **Figure 5.5**).

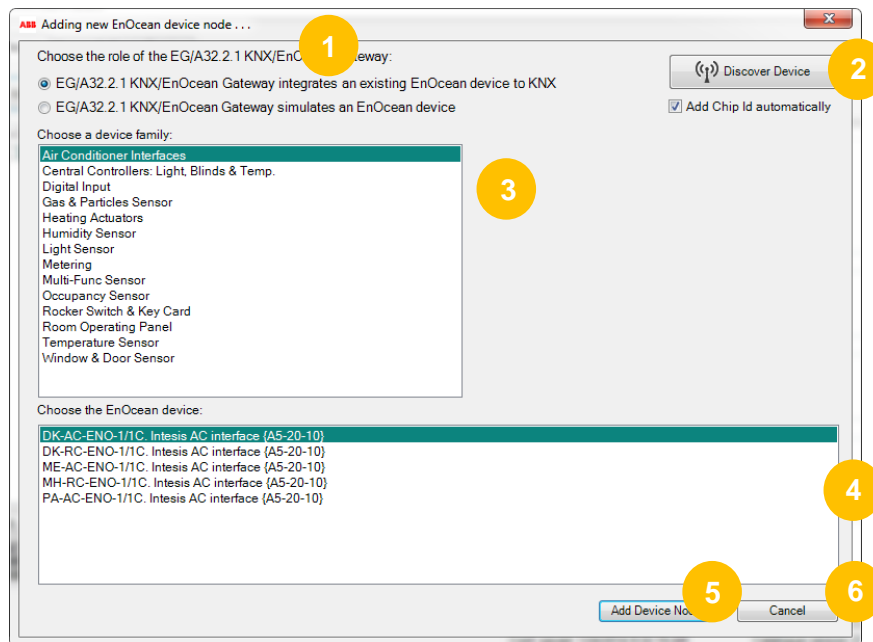

Figure 5.5 Add device pop up screen

- 1 KNX/EnOcean Gateway role:** Select one of the radio buttons to get integration from KNX to EnOcean or from EnOcean to KNX.

The KNX/EnOcean integrates an existing EnOcean device to KNX: Adds a new physical EnOcean device to the current configuration.

The KNX/EnOcean simulates an EnOcean device: Adds a new simulated EnOcean device. *An EnOcean device is simulated from KNX (e.g. An EnOcean window contact could be simulated by using a KNX binary input contact).*
- 2 Discover device:** Click on the **Discover device** button and on the Teach-in/learning button of your EnOcean device. This will automatically select your device from the ones in the list² and will add the ChipID information³. If you want to add the Chip ID automatically, please check the *Add Chip ID automatically* check box.
- 3 Choose a family device:** Select the group from the list that owns the EnOcean device to be integrated to find the proper device faster and in an easy way.
- 4 Choose the EnOcean device:** Select the EnOcean device to be integrated from the list.
- 5 Add device:** Adds the selected EnOcean device.
- 6**

² In some cases, the application is not capable of establishing a one-to-one relation. In these cases, user only has to decide which is the precise device, but doesn't have to look for the whole catalogue, as a preselecting is done by the plugin.

³ This is not available for the rocker buttons and the AC devices. In these cases you will need to use the standard teach-in/learn process in the **Remote EnOcean Teach-in** tab of this same plugin.

Cancel: Cancel the process.

The process to add a device is quite simple and can be done in two different ways:

- a. Manually: You only have to look into the list for the EnOcean device family of the device to be added, then select the device and finally click on the **Add Device Node** button.

To add new devices just repeat the process as many times as EnOcean devices you want to integrate or simulate.

- b. Remotely: Press **Discover Device** button on the plugin and then press the Teach-in/learning (LRD) button on the EnOcean device that you want to integrate.

Remember that this function is only available for the integration of EnOcean devices and not for the simulation scenario.

Please, keep in mind that rocker buttons need a specific operation when Teach-in, as A0 button of the rocker needs to be pushed to ensure proper switch position is configured (see Figure 5.6).

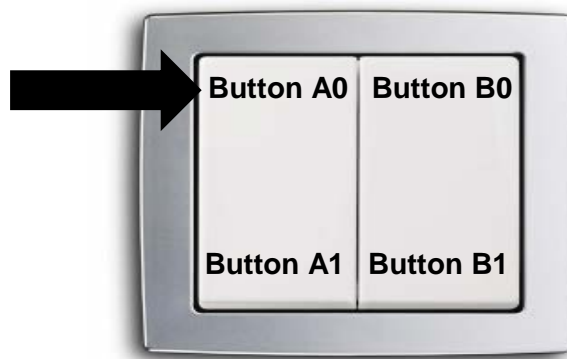

Figure 5.6 Indication on a rocker ChipID addition

To add another device, click again on the teaching/learning (LRD) button. Once you finish adding devices, click on the Done button if you don't want to wait for the countdown to finish.

To **erase** an EnOcean device you have to select it in the plugin tree-view and click on the **Remove Device Node** button. The plugin will ask you for confirmation.

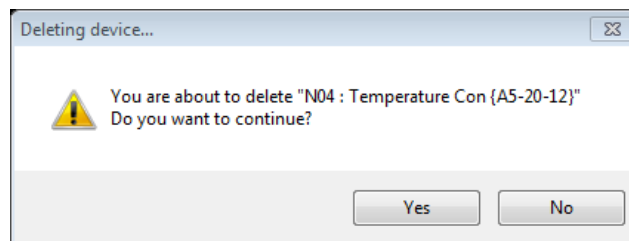

Figure 5.7 Confirm erasing an EnOcean device screen

In case you want to erase all the devices and device nodes, click on the **Reset Configuration** button. This action will erase all current configuration including devices, device nodes and chipID information.

5.1.2 General device settings

For each EnOcean device, there is a list of general settings that can be configured to ease the setup process. The list of available settings is listed in the KNX communication objects settings part of the screen. Bellow, there is a list of all available parameters. Keep in mind that these parameters will appear depending on the EnOcean device selected. Not all parameters are available for all EnOcean devices.

- a. **Wait for data integrity before transmitting to EnOcean:** When selected, no data will be transmitted to the EnOcean interface until all data needed by the device is received from the KNX interface.
- b. **EnOcean periodic output update:** Indicates the period (in seconds) that the existing values will be sent from the EnOcean part cyclically. It can be switched off (disable) or set with following values: 30s, 1 min, 2 min, 5 min, 10 min, 20 min, 30 min or 40 min.
- c. **Edit initial data:** Click on the link to pop-up a configuration window where default or initial values can be set according to each EnOcean device. Check the link to the EEP list to know exactly with type and range of values can be applied in each case.
- d. **Hide controls of KNX periodic updates:** When selected, **KNX periodic input update** parameter for each communication object is not shown.
- e. **Contact:** Indicates the functionality of the gateway when receiving messages from the EnOcean device. Different options are:
 - i. **Report last value reported by any device**
 - ii. **Report "Open" only when all devices report "Open"**
 - iii. **Report "Closed" only when all devices report "Closed"**
- f. **Groupings:** Used to select the working mode of the rocker buttons. For each button and for each channel (pair of buttons) you have 4 different modes: *none, switching, dimming or shutter/blind*. More information about these modes and the associated DTP can be found in section 8.

5.1.3 Communication objects parameters

Depending on the communication object, certain parameters can be set up. Next, you have the list of those available parameters grouped as integrated devices and simulated devices.

A. Integrated devices

Device	Parameter	Description
General	KNX periodic input update	Indicates the period (in seconds) that the existing values will be read from KNX cyclically. (0= disabled; values from 10 to 2550, multiple of 10)
Room Operating Panel	Minimum/Maximum temperature setpoint	Indicates the maximum and minimum setpoint temperature desired in the project. (Expressed in °C, range may vary depending on each device)
Rocker Switch	Switching operation:	Functionality of the button when pressed. (On, Off or Toggle)
	Short/long pulse threshold	Amount of time the button needs to be pressed to be interpreted as a long pulse. (Expressed in ms)
	Dimming operation for short (long) pulse:	Functionality of the button when pressed and dimming mode is selected. (On (increase), Off (decrease) or Toggle)

	Dimming increase step value (on long pulse):	Defines the step value for the increase step when dimming mode is selected and long pulse is carried out.
	Dimming decrease step value (on long pulse)	Defines the step value for the decrease step when dimming mode is selected and long pulse is carried out.
	Dimming periodic step value sending (on long pulse)	Defines the amount of time that it takes to move from one step to the next one when the button is constantly pressed. This parameter will help in achieving a smoother dimming effect if combined with small step values.
	Shutter/Blind operation	Functionality of the button when pressed. (Up, Down or Toggle)
	Shutter/Blind method	Functionality of the button when pressed. (Move-Step or Step-Move-Step)
	Shutter/Blind vanes adjustment time	Defines the amount of time that it takes to move from one position to the next one.
	Shutter/Blind operation (top button / bottom button)	Functionality of the button when pressed. (UP-Down or Down-UP)
	Send temperature	Writes a KNX temperature value. (Expressed in °C, range may vary depending on each device)
	Send value	Writes a KNX value. (values from 0 to 255)

B. Simulated devices

Device	Parameter	Description
General	KNX periodic output update	Indicates the period (in seconds) that the existing values will be sent to KNX cyclically. (0= disabled; values from 10 to 2550, multiple of 10).
Room Operating Panel	Minimum/Maximum temperature setpoint	Indicates the maximum and minimum setpoint temperature desired in the project. (Expressed in °C, range may vary depending on each device)
Rocker Switch	On button	Functionality of the button when pressed. (On message is simulated)
	Off button	Functionality of the button when pressed. (Off message is simulated)
	Increase button	Functionality of the button when pressed. (Increase message is simulated)
	Decrease button	Functionality of the button when pressed. (Decrease message is simulated)
	Min. to max. intensity time	Indicates the time elapsed , expressed in ms, between the minimum and maximum intensity value
	Up button	Functionality of the button when pressed. (Up message is simulated)
	Down button	Functionality of the button when pressed. (Down message is simulated)

5.1.4 Enable and disable communication objects

Once we have one or several EnOcean devices, these and their communication objects will appear in the plugin tree-view (expand the devices in order to see the communication objects or click on **Expand** button).

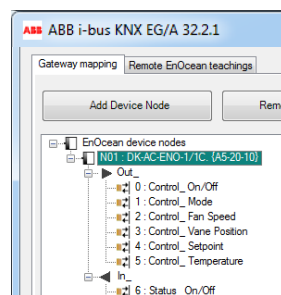

Figure 5.8 Plugin tree view

The greyed communication objects are disabled. To enable these objects just click on them with the mouse right-button and select **Enable**. To disable them, repeat the same process but selecting **Disable**.

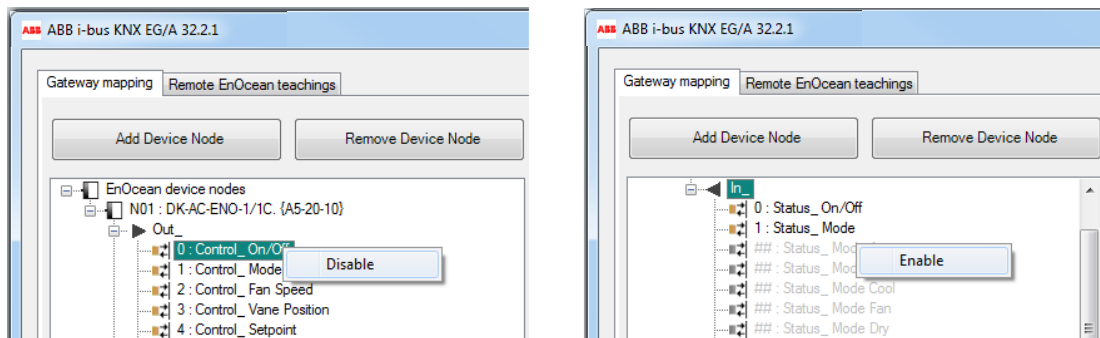

Figure 5.9 Enable Disable EnOcean devices

To check the datapoint type (DPT) and the functionality for each communication object simply point the mouse over the desired object and this information will appear. This is very useful in order to know which value sent from KNX enables the desired feature associated to the communication object. A summary of this information can be found on the section 8 of this document.

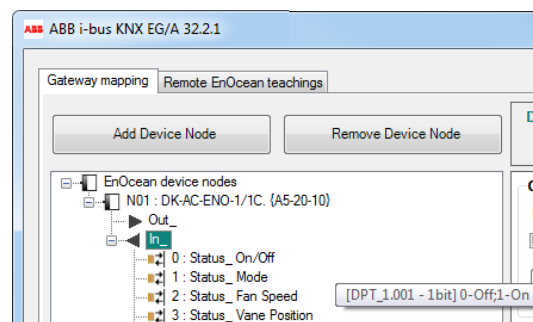

Figure 5.10 Communication object DPT information

In some cases, when grouping is active for instance, enabling and disabling communication objects from the device tree is not allowed. Therefore, if you are trying to disable/enable a communication object from a rocker button, make sure that you use the General settings section to do it and not right clicking on the device tree directly.

5.1.5 Add a new catalogue

Our catalogues include all available EnOcean devices that can be integrated into KNX through our gateway. When new products are included in the catalogue this file has to be updated to configure the gateway using these new products.

To do it so, please download the latest version of the catalogue through our web site. Then click on the **Import Catalogue** button and select the location of the file that has to be imported (see Figure 5.11 for more details).

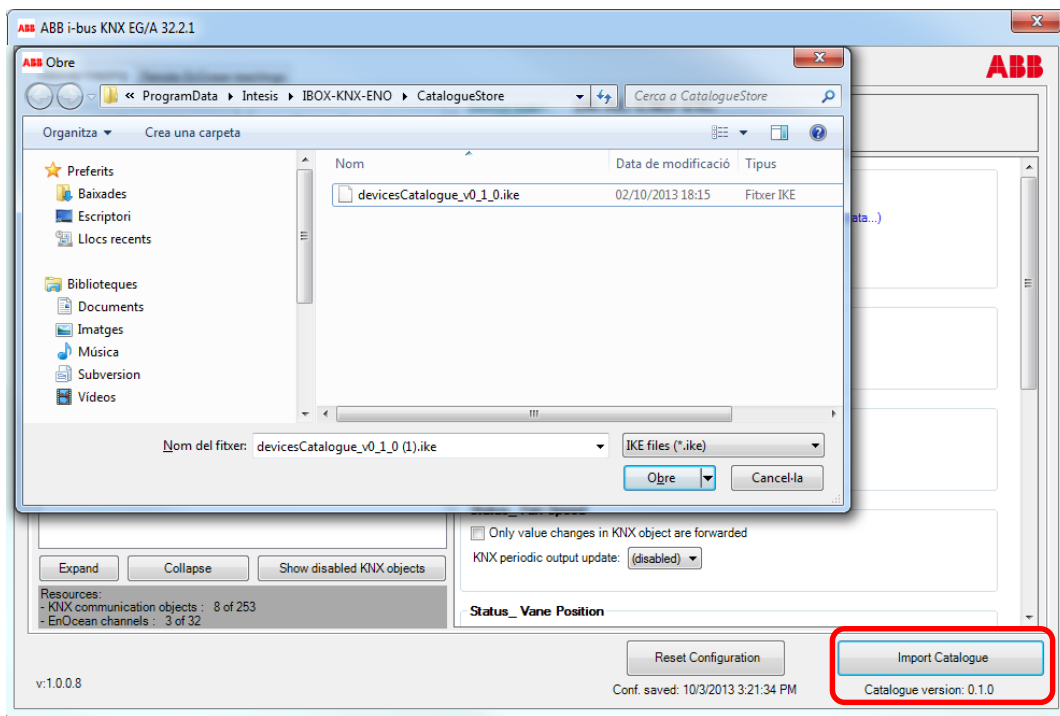

Figure 5.11 Importing new catalogue

Remember that you can only use IKE files provided by ABB.

5.2 Remote EnOcean Teach-in/Learning

Once you have customized device parameters and communication objects, it is time to import EnOcean device chip information to establish proper communication between our KNX/EnOcean Gateway device and the EnOcean devices.

KNX/EnOcean Gateway offers two different modalities to *Learn/Teach-in* EnOcean devices. You can program them by pressing the Teach-in button on the device itself (see section 6) or you can use the remote option of our plugin.

In case you want to Teach/Learn EnOcean devices manually, you just have to close the KNX/EnOcean plugin and download your configuration as usual from ETS. On the other hand, if you want to carry out the Teach-in/Learning process remotely, please go to the **Remote EnOcean Teach-in/Learning** tab (see Figure 5.12).

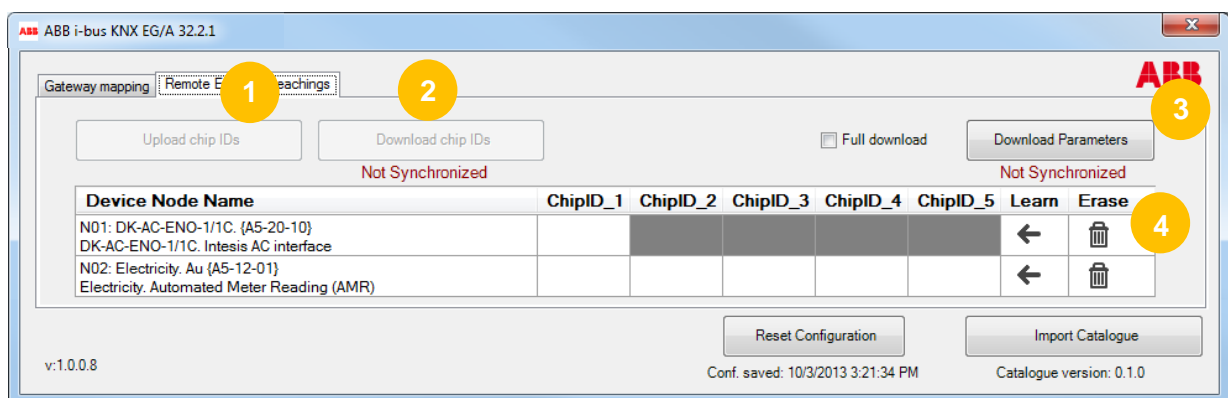

Figure 5.12 Remote EnOcean Teach-in/Learning screen

- 1 Upload chipIDs:** When pressing this button, information regarding Chip IDs stored in the Gateway is sent to the ETS plugin. A progress bar message will appear indicating the uploading status.

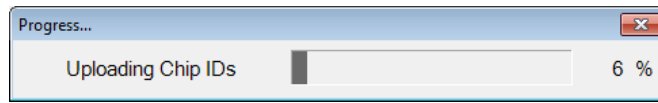

Figure 5.13 Uploading Chip ID

Once information is imported a finish message will pop-up, indicating successful results for the operation.

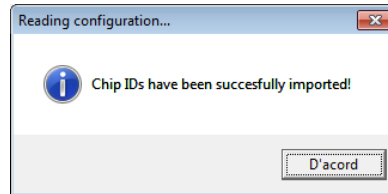

Figure 5.14 Confirmation message after Chip ID upload

This step has to be performed every time a device (or devices) is (are) added or erased using the gateway and you want them to be shown in the plugin.

- 2 Download chipIDs:** When pressing this button, information regarding Chip IDs stored in the ETS plugin is downloaded to the gateway. If gateway parameters were not synchronized, the plugin will ask the user to synchronize information at both sides before proceeding with Chip ID downloading.

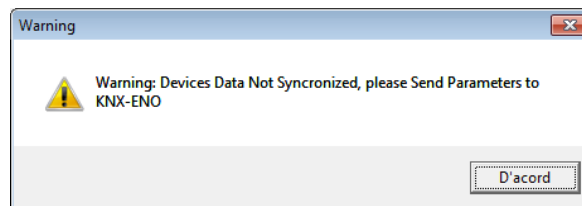

Figure 5.15 Devices data not synchronized message

Text below the button indicates whether information in the ETS has been synchronized or not with the information in the gateway. If information is not synchronized, text will appear red (see Figure 5.16) indicating there is no synchronism between plugin information and gateway information.

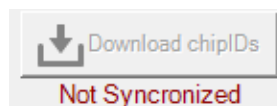

Figure 5.16 Chip IDs not synchronized message

As well as with the Upload chipIDs button, during downloading process a window will pop-up indicating the uploading status.

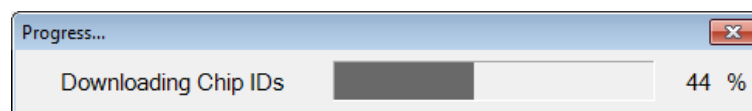

Figure 5.17 Downloading Chip ID

This is an important step and it has to be performed every time a device (or devices) is (are) added or erased.

- 3 Download parameters:** Before starting Uploading/Downloading Chip IDs, information on the gateway and the ETS should be synchronized. The text below the button will indicate if the system is synchronized or not.

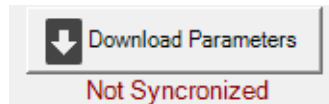

Figure 5.18 Parameters not synchronized message

In case it is not, please proceed to download parameters pressing the button. When doing so, the plugin will warn the user about the procedure, so previous configuration will be erased.

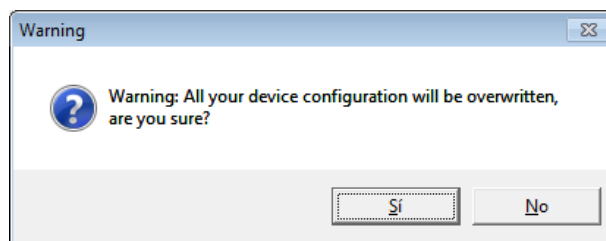

Figure 5.19 Warning message regarding overwriting previous configuration

When downloading parameters you have the option to carry out a full download or a partial download. When check box is not enabled, a partial download is carried out (just downloading the modifications with respect the previous integration configuration). On the other hand, when the Full Download checkbox is enabled it downloads the complete integration configuration and parameters.

Download process lasts some seconds and when finished the added devices will be shown in the LCD of the KNX/EnOcean Gateway device display (press the up/down buttons of the gateway to see them).

- 4 Device table:** In this table all devices integrated in the project will appear letting the user learn or erase Chip ID information from them. Basically, information shown is:

- **Device Node Name:** Provides information about the name of the node where the device is setup.
- **chipID_1-2-3-4-5:** Provides information about the Chip ID of the integrated (or simulated) EnOcean devices in each node. Up to 5 different devices can be added in a single node.
- **Learn:** When pressing this arrow, a countdown time starts in which you can press the teach-inbutton from your EnOcean device (the one that you want to integrate) so the gateway can learn the Chip ID.

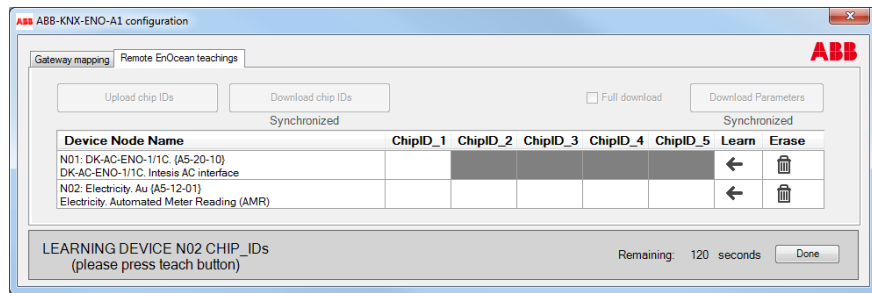

Figure 5.20 Learning process

If devices are learned before countdown reaches the end, you can press the **Done** button so the countdown stops.

When the arrow is in the opposite directions (see Figure 5.21), implies that the device is simulated, so instead of learning the device it has to be taught. To do it so, press the arrow. Then a pop-up message will appear indicating that you have to press the Learn button of your EnOcean device and after that the information of the KNX/EnOcean Gateway will be taught and stored in the EnOcean device.

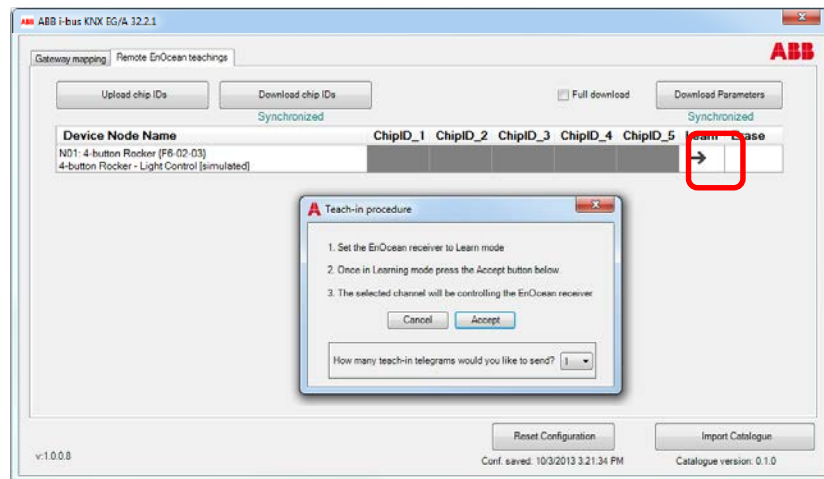

Figure 5.21 Teach-in process

- **Erase:** When pressing on the trash icon a new window will pop-up (see Figure 5.22). On this screen, user will see all Chip IDs from the associate node and will be able to delete each Chip ID individually. Remember to press the **Save changes** button before closing the window.

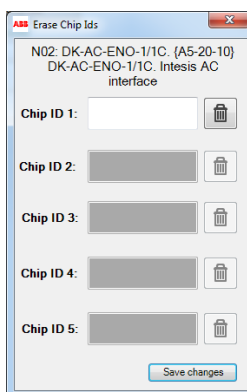

Figure 5.22 Erasing process

6 Device programming and monitoring buttons

The KNX/EnOcean Gateway includes programming buttons in case you want to program or monitor devices without the help of our ETS plugin. We recommend to use the plugin for the programming of the gateway. The following and in chapter 10 shown possibilities are only an additional feature.

In **Figure 6.1** you can see the available buttons and below you can find an explanation about them.

NOTE: It is not possible to add new device nodes with the programming buttons. You must to use the ETS plugin for this.

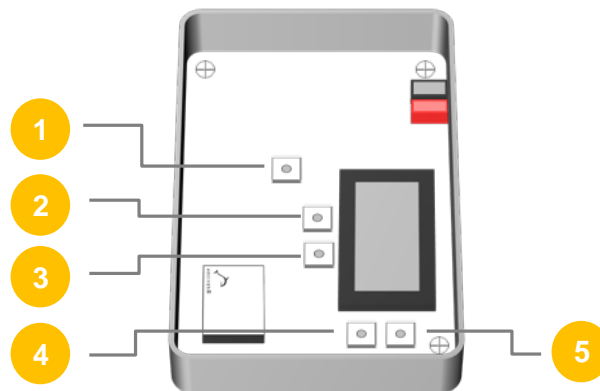

Figure 6.1 KNX/EnOcean Gateway interior view

- 1 **KNX Prog Button:** Button used to program the KNX physical address into the gateway.
- 2 **Erase Button:** Button used to erase linked EnOcean devices and nodes.
- 3 **Learn/Teach button:** Button used to link and monitor EnOcean devices.
- 4 **Up arrow button:** Browse configured device list in an ascending way.
- 5 **Down arrow button:** Browse configured device list in a descending way.

More information about programming buttons and all functionalities available can be found in section 10.

6.1 Learn/Teach-in EnOcean devices

When learning EnOcean devices are linked with the gateway, **Teach** button from our gateway has to be pressed and an “L” appears on the right side of the LCD display. Then the gateway will be in “**Learn**” mode. In order to link an EnOcean device with the device appearing in the LCD display, click on the Learn/Teach-in button from the EnOcean device and it will be linked. It

is possible to check that the device has been learned in the numeric indicator of the LCD display.

When learning EnOcean gateways for AC, the process will last few seconds and meanwhile the “ongoing” text will be shown in the LCD.

In the specific case of rocker buttons, keep in mind that the A0 button needs to be pressed in order to link the device properly and in a coherent way (see **Figure 6.2**).

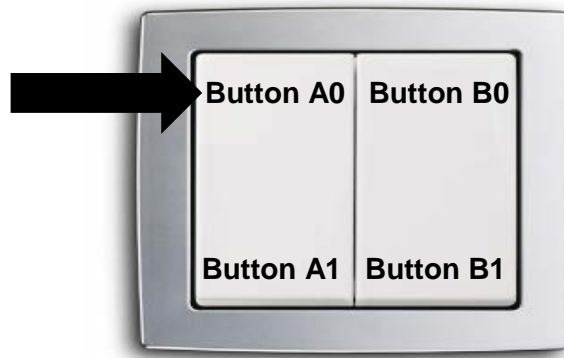

Figure 6.2 Indication on the rocker button that has to be pushed during teach-in process

In case of teach-in process, first press the Learn button of the EnOcean device that has to learn the KNX/EnOcean Gateway chipID. Once the device is ready to receive other EnOcean devices information, press the Teach button of our gateway. A “T” appears on the right side of the LCD display indicating Teach-in process is running. For more information on how to activate the Learn mode of the EnOcean device, please consult its user manual.

6.2 Erase EnOcean devices

Three different erase modes are available: erase the current device, erase all devices in the current device node and erase all devices from all nodes.

6.2.1 Erase current integrated device.

First, use the arrow buttons (UP/DOWN) to move up to the desired device that you want to erase. When pressing the **Erase** button an “E” appears on the right side of the LCD display. Then the gateway will be in “Erase” mode. To erase the desired EnOcean device, click on the Learn/Teach-in button from the device and it will be erased. It is possible to check that the device has been erased in the numeric indicator of the LCD display. This mode is only available for integrated devices, not for simulated ones.

6.2.2 Erase all devices in a Device Node

*If pressed long (more than 2 seconds) an option to erase the whole node will be shown (press **Erase** button again to confirm).*

In case you want to erase all devices in a node, please push the **Erase** button for 2 seconds. The device will ask for erasing the current node. By pressing again the **Erase** button, we will erase all devices in that node. The node itself will not be erased. This can only be done through the plugin.

On the other hand, if you want to erase all devices in all nodes, push buttons 2,3,4 and 5 at the same time. Display will prompt a message asking for erasing all nodes. By pressing **Erase** button, all devices from all nodes will be erased.

Remember that nodes themselves will not be erased. This can only be done through the plugin.

6.3 Monitor mode

If pressing the **Learn/Teach-in** button long (more than 2 seconds) the gateway will enter in Monitor Mode. In this mode is possible to check the signal quality from each EnOcean device linked.

To do so, simply enter to this mode, and press the **Learn/Teach-in** button from the EnOcean device you want to check. A value in % will appear in the LCD indicating the signal strength. Also the node and device number will be shown.

An extra function that is also available for visualization information improvement is the contrast function. This function can be activated by pushing UP and Down buttons simultaneously for more than 2 seconds. After that, by pressing the Up and Down buttons you will be able to increase or decrease the display contrast.

6.4 Programming KNX physical address

In order to configure the gateway's physical address on the KNX side, you need to use the ETS and the **KNX Prog** button. To do it so, go to the ETS download section (see **Figure 6.3**).

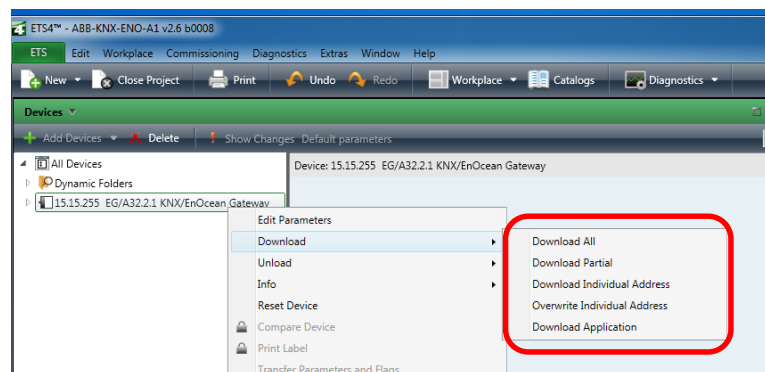

Figure 6.3 Download section on ETS

Depending on the changes you have done, the ETS will ask you to press the programming button (see **Figure 6.4**). Push the **KNX Prog** button once (internal LED will turn on in red color). After that, configuration process will start. Once download is finish, the gateway LED will turn off automatically.

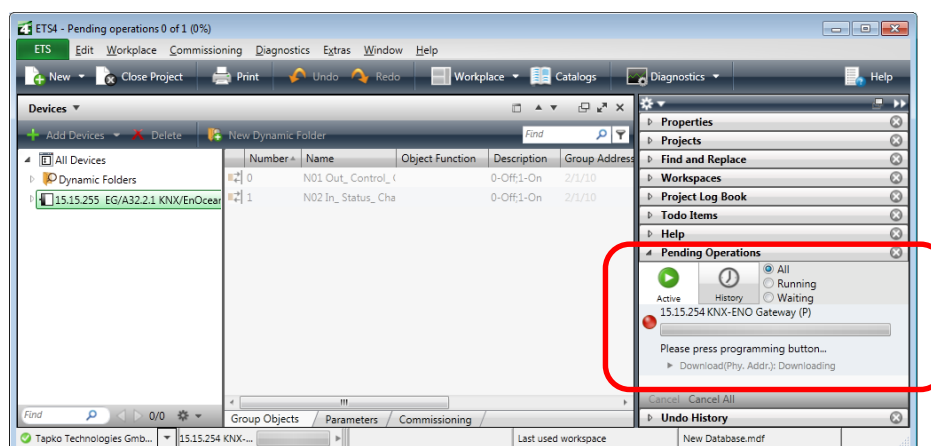
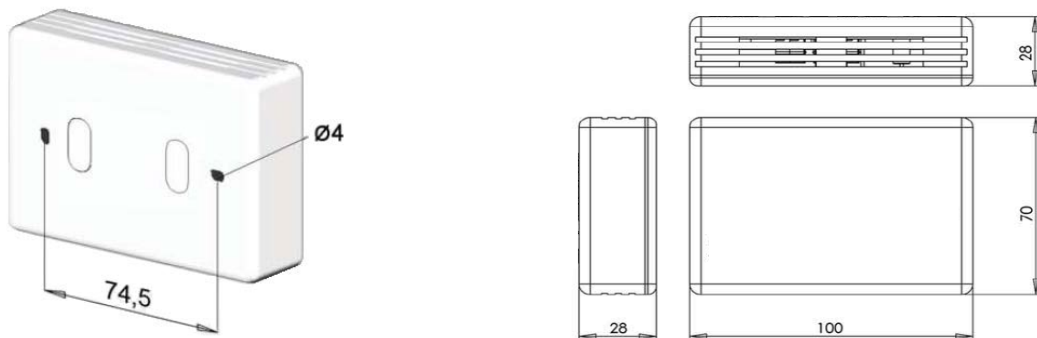

Figure 6.4 Press **KNX Prog** button message

7 Technical Specifications



Enclosure	Material: ABS (UL 94 HB). 2,5 mm thickness Size: 70 x 100 x 28 mm Weight: 97g Color: White
Power supply	29V DC, 11mA Supplied through KNX bus.
Power consumption	max. 320 mW
Mounting	Surface mounted: Wall or ceiling
LED indicators (internal)	1 x KNX programming.
LCD Display (internal)	2x8 Characters STN Positive (Yellow-green) Reflective type Without backlight
Push buttons	1 x KNX programming. 2 x LCD display control 1 x Erase EnOcean devices 1 x Teach-in / Learn EnOcean devices
Operating Temperature	From 0°C a 40°C
Operating humidity	<93% HR, no condensation
Stock humidity	<93% HR, no condensation
RoHS conformity	Compliant with RoHS directive (2002/95/CE).
Certifications	<p>KNX/EnOcean Gateway:</p> <ul style="list-style-type: none"> • CE conformity to EMC directive (2004/108/EC) and Low-voltage directive (2006/95/EC) <ul style="list-style-type: none"> ○ EN 301489-1 V1.8.1 ○ EN 60950-1 ○ EN 50491-3 ○ EN 50090-2-2 <p>KNX/EnOcean Gateway:</p> <ul style="list-style-type: none"> • FCC (ID: SZV-STM300C) • IC (ID: 5713A-STM300C)

8 Appendix A – EnOcean Family Communication Objects Tables ¹

8.1 AC interface

FUNCTION	NAME	LENGTH	DATAPOINT TYPE		FLAGS				VALUES
			DPT_NAME	DPT_ID	R	W	T	U	
On/Off	Control_ On/Off	1 bit	DPT_Switch	1.001		W	T		0 - Off; 1-On
Mode	Control_ Mode	1 byte	DPT_HVACContrMode	20.105		W	T		0 - Auto; 1 - Heat; 3 - Cool; 9 - Fan; 14 - Dry
	Control_ Mode Auto	1 bit	DPT_Bool	1.002		W	T		1 - Auto
	Control_ Mode Heat	1 bit	DPT_Bool	1.002		W	T		1 - Heat
	Control_ Mode Cool	1 bit	DPT_Bool	1.002		W	T		1 - Cool
	Control_ Mode Fan	1 bit	DPT_Bool	1.002		W	T		1 - Fan
	Control_ Mode Dry	1 bit	DPT_Bool	1.002		W	T		1 - Dry
Fan Speed	Control_ Fan Speed / 14 Speeds	1 byte	DPT_Scaling	5.001		W	T		%
	Control_ Fan Speed / 14 Speeds	1 byte	DPT_Enumerated	5.010		W	T		1 - Speed 1; 2 - Speed 2; 3 Speed 3; ...; 14 Speed 14
	Control_ Fan Speed Manual/Auto	1 bit	DPT_Bool	1.002		W	T		0 - Manual; 1 - Auto
	Control_ Fan Speed 1	1 bit	DPT_Bool	1.002		W	T		1 - Fan Speed 1
	Control_ Fan Speed 2	1 bit	DPT_Bool	1.002		W	T		1 - Fan Speed 2
	Control_ Fan Speed 3	1 bit	DPT_Bool	1.002		W	T		1 - Fan Speed 3
	Control_ Fan Speed 4	1 bit	DPT_Bool	1.002		W	T		1 - Fan Speed 4
	Control_ Fan Speed 5	1 bit	DPT_Bool	1.002		W	T		1 - Fan Speed 5

¹ In case of a simulated EnOcean device, Control_ objects become Status_ objects and vice versa, except the Control_ and Status_ objects for AC interfaces, HVAC devices and Rocker Switch devices.

Vanes	Control_ Vane Position	1 byte	DPT_Scaling	5.001		W	T	%
	Control_ Vane Position / 5 Positions	1 byte	DPT_Enumerated	5.010		W	T	1 - Position 1; 2 - Position 2; 3 Position 3; 4 - Position 4; 5 Position 5
	Control_ Vane Manual/Auto	1 bit	DPT_Bool	1.002		W	T	0 – Position 1; 1 - Auto
	Control_ Vane Position 1	1 bit	DPT_Bool	1.002		W	T	1 - Position 1
	Control_ Vane Position 2	1 bit	DPT_Bool	1.002		W	T	1 - Position 2
	Control_ Vane Position 3	1 bit	DPT_Bool	1.002		W	T	1 - Position 3
	Control_ Vane Position 4	1 bit	DPT_Bool	1.002		W	T	1 - Position 4
	Control_ Vane Position 5	1 bit	DPT_Bool	1.002		W	T	1 - Position 5
	Control_ Vane Swing	1 bit	DPT_Bool	1.002		W	T	0 – Position 1; 1 - Swing
Temperature	Control_ Setpoint	1 byte	DPT_Scaling	5.001		W	T	(°C)
	Control_ Setpoint	2 bytes	DPT_Value_Temp	9.001		W	T	(°C)
	Control_ Temperature	2 bytes	DPT_Value_Temp	9.001		W	T	(°C)
	Control_ Ambient Temperature	2 bytes	DPT_Value_Temp	9.001		W	T	(°C)
Window	Control_ Window Contact	1 bit	DPT_OpenClose	1.009		W	T	0 - Open; 1 - Closed
	Control_ Window Contact	1 bit	DPT_Window_Door	1.019		W	T	0 - Closed; 1 - Open
External	Control_ External disablement	1 bit	DPT_Bool	1.002		W	T	0 - False; 1 - True
	Control_ External disablement	1 bit	DPT_Enable	1.003		W	T	0 - Disable; 1 - Enable
Locking	Control_ Disable Remote Control	1 bit	DPT_Bool	1.002		W	T	0 - False; 1 - True
	Control_ Disable Remote Control	1 bit	DPT_Enable	1.003		W	T	0 - Disable; 1 – Enable

On/Off	Status_ On/Off	1 bit	DPT_Switch	1.001	R	T	0 - Off; 1-On
	Status_ Mode	1 byte	DPT_HVACContrMode	20.105	R	T	0 - Auto; 1 - Heat; 3 - Cool; 9 - Fan; 14 - Dry
Mode	Status_ Mode Auto	1 bit	DPT_Bool	1.002	R	T	1 - Auto
	Status_ Mode Heat	1 bit	DPT_Bool	1.002	R	T	1 - Heat
	Status_ Mode Cool	1 bit	DPT_Bool	1.002	R	T	1 - Cool
	Status_ Mode Fan	1 bit	DPT_Bool	1.002	R	T	1 - Fan
	Status_ Mode Dry	1 bit	DPT_Bool	1.002	R	T	1 - Dry
	Status_ Fan Speed / 14 Speeds	1 byte	DPT_Scaling	5.001	R	T	%
Fan Speed	Status_ Fan Speed / 14 Speeds	1 byte	DPT_Enumerated	5.010	R	T	1 - Speed 1; 2 - Speed 2; 3 Speed 3; ...; 14 Speed 14
	Status_ Fan Speed Manual/Auto	1 bit	DPT_Bool	1.002	R	T	0 – Manual; 1 - Auto
	Status_ Fan Speed 1	1 bit	DPT_Bool	1.002	R	T	1 - Speed 1
	Status_ Fan Speed 2	1 bit	DPT_Bool	1.002	R	T	1 - Speed 2
	Status_ Fan Speed 3	1 bit	DPT_Bool	1.002	R	T	1 - Speed 3
	Status_ Fan Speed 4	1 bit	DPT_Bool	1.002	R	T	1 - Speed 4
	Status_ Fan Speed 5	1 bit	DPT_Bool	1.002	R	T	1 - Speed 5
Vaness	Status_ Vane Position	1 byte	DPT_Scaling	5.001	R	T	%
	Status_ Vane Position / 5 Positions	1 byte	DPT_Enumerated	5.010	R	T	1 - Position 1; 2 - Position 2; 3 Position 3; 4 - Position 4; 5 Position 5
	Status_ Vane Manual/Auto	1 bit	DPT_Bool	1.002	R	T	0 – Position 1; 1 - Auto
	Status_ Vane Position 1	1 bit	DPT_Bool	1.002	R	T	1 - Position 1
	Status_ Vane Position 2	1 bit	DPT_Bool	1.002	R	T	1 - Position 2
	Status_ Vane Position 3	1 bit	DPT_Bool	1.002	R	T	1 - Position 3

	Status_ Vane Position 4	1 bit	DPT_Bool	1.002	R	T	1 - Position 4
	Status_ Vane Position 5	1 bit	DPT_Bool	1.002	R	T	1 - Position 5
	Status_ Vane Swing	1 bit	DPT_Bool	1.002	R	T	0 – Position 1; 1 - Swing
Temperature	Status_ Setpoint	1 byte	DPT_Scaling	5.001	R	T	(°C)
	Status_ Setpoint	2 bytes	DPT_Value_Temp	9.001	R	T	(°C)
	Status_ Temperature	2 bytes	DPT_Value_Temp	9.001	R	T	(°C)
Alarm	Status_ Alarm State	1 bit	DPT_Alarm	1.005	R	T	0 – No alarm; 1 - Alarm
Error	Status_ Error code	2 bytes	DPT_Value_2_Ucount	7.001	R	T	AC error (0 - no error)
Window	Status_ Window Contact	1 bit	DPT_OpenClose	1.009	R	T	0 - Open; 1 - Closed
	Status_ Window Contact	1 bit	DPT_Window_Door	1.019	R	T	0 - Closed; 1 - Open
External	Status_ External disablement	1 bit	DPT_Bool	1.002	R	T	0 - False; 1 - True
	Status_ External disablement	1 bit	DPT_Enable	1.003	R	T	0 - Disable; 1 - Enable
Locking	Status_ Disable Remote Control	1 bit	DPT_Bool	1.002	R	T	0 - False; 1 - True
	Status_ Disable Remote Control	1 bit	DPT_Enable	1.003	R	T	0 - Disable; 1 – Enable

8.2 Digital Input

FUNCTION	NAME	LENGTH	DATAPOINT TYPE		FLAGS				VALUES
			DPT_NAME	DPT_ID	R	W	T	U	
Alarm	Status_Low Battery Alarm	1 bit	DPT_Alarm	1.005	R		T		0 – No alarm; 1 - Alarm
Input	Status_ Input State	1 bit	DPT_OpenClose	1.009	R		T		0 – Open; 1 – Close

8.3 Central Controllers: Lights, blinds and temperature

FUNCTION	NAME	LENGTH	DATAPOINT TYPE		FLAGS				VALUES
			DPT_NAME	DPT_ID	R	W	T	U	
Light	Status_ Daylight Harvesting	1 bit	DPT_Enable	1.003	R		T		0 – Disable; 1 – Enable
	Status_ Dimming Level	1 byte	DPT_Scaling	5.001	R		T		%
	Status_ Switching/Dimming Load	1 bit	DPT_Bool	1.002	R		T		0 – Switching; 1 - Dimming
	Status_ Illumination	2 bytes	DPT_Value_Lux	9.004	R		T		lux
	Status_ Illumination Setpoint	1 byte	DPT_Scaling	5.001	R		T		%
	Status_ Magnet Contact	1 bit	DPT_OpenClose	1.009	R		T		0 – Open; 1 – Close
	Status_ Power Relay	1 bit	DPT_Switch	1.001	R		T		0 – Off; 1 - On
	Status_ Power Relay Timer	1 bit	DPT_Enable	1.003	R		T		0 – Disable; 1 – Enable
	Status_ Repeater	1 bit	DPT_Enable	1.003	R		T		0 – Disable; 1 – Enable
	Status_ Occupancy	1 bit	DPT_Occupancy	1.018	R		T		0 – Not occupied; 1 – Occupied
Temperature	Status_ Actual Setpoint	2 bytes	DPT_Value_Temp	9.001	R		T		°C
	Status_ Alarm	1 bit	DPT_Alarm	1.005	R		T		0 – No alarm; 1 - Alarm
	Status_ Automatic/Override	1 bit	DPT_Bool	1.002	R		T		0 – Auto; 1 - Override
	Status_ Control Variable	1 byte	DPT_Scaling	5.001	R		T		%
	Status_ Controller Mode On/Off	1 bit	DPT_Switch	1.001	R		T		0 – Off; 1 – On
	Status_ Controller Cool/Heat	1 bit	DPT_Heat/Cool	1.100	R		T		0 – Cooling; 1 – Heating
	Status_ Controller Mode	1 byte	DPT_ErrorClass_HVAC	20.012	R		T		1 – Heat; 3 – Cool; 6 - Off

	Status_ Fan Man/Auto	1 bit	DPT_Bool	1.002	R	T	0 – Normal; 1 – Auto
	Status_ Fan Stage	1 byte	DPT_Scaling	5.001	R	T	%
	Status_ Fan Stage Available	1 bit	DPT_Bool	1.002	R	T	0 – False; 1 – True
	Status_ Normal /Hold-off Stop	1 bit	DPT_Bool	1.002	R	T	0 – Normal; 1 – Hold-off
	Status_ Room Occupancy	1 bit	DPT_Occupancy	1.018	R	T	0 – Not occupied; 1 – Occupied
	Status_ Room Occupancy Frost	1 bit	DPT_Bool	1.002	R	T	0 – False; 1 – True
	Status_ Room Occupancy Mode	1 byte	DPT_OccMode	20.003	R	T	HVAC Control Mode
PHC 1	Status_ Temperature	2 bytes	DPT_Value_Temp	9.001	R	T	°C
PHC 2	Status_ Control Variable	1 byte	DPT_Scaling	5.001	R	T	%
	Status_ Controller Mode Off/Auto	1 bit	DPT_Bool	1.002	R	T	0 – Off; 1 – Auto
	Status_ Controller Cool/Heat	1 bit	DPT_Bool	1.002	R	T	0 – Cooling; 1 – Heating
	Status_ Controller Mode	1 byte	DPT_ErrorClass_HVAC	20.012	R	T	1 – Heat; 3 – Cool; 6 - Off
	Status_ Normal/Hold-off Stop	1 bit	DPT_Bool	1.002	R	T	0 – False; 1 – True
	Status_ Room Occupancy	1 bit	DPT_Occupancy	1.018	R	T	0 – Not occupied; 1 – Occupied
	Status_ Room Occupancy Mode	1 byte	DPT_OccMode	20.003	R	T	HVAC Control Mode
PHC 3	Status_ Dimming Value	1 byte	DPT_Scaling	5.001	R	T	%
	Status_ Ramping Time	2 bytes	DPT_Time_Periodic_Sec	7.005	R	T	Seconds
	Status_ Absolute/Relative Range	1 bit	DPT_Bool	1.002	R	T	0 – Absolute; 1 – Relative
	Status_ Store Final Value	1 bit	DPT_Bool	1.002	R	T	0 – False; 1 – True
	Status_ Switching Command	1 bit	DPT_Switch	1.001	R	T	0 – Off; 1 – On
PHC 4	Status_ Fan Stage	1 byte	DPT_Scaling	5.001	R	T	%

	Status_ Fan Man/Auto	1 bit	DPT_Bool	1.002	R		T		0 – Man; 1 – Auto
PHC 5	Status_ Setpoint Shift	2 bytes	DPT_Value_Tempd	9.002	R		T		°K
PHC 6	Status_ Locked	1 bit	DPT_Bool	1.002	R		T		0 – Unlocked; 1 – Locked
	Status_ Delay/Duration	1 bit	DPT_Bool	1.002	R		T		0 – Delay; 1 - Duration
	Status_ Switching Command	1 bit	DPT_Switch	1.001	R		T		0 – Off; 1 – On
	Status_ Time	2 bytes	DPT_Time_Periodic_Sec	7.005	R		T		Seconds

8.4 Gas and Particles Sensor

FUNCTION	NAME	LENGTH	DATAPOINT TYPE		FLAGS				VALUES
			DPT_NAME	DPT_ID	R	W	T	U	
Particles	Status_ Concentration1	2 bytes	DPT_AirQuality	9.008	R		T		ppm
	Status_ Concentration2	2 bytes	DPT_AirQuality	9.008	R		T		ppm
Temperature	Status_Temperature	2 bytes	DPT_Value_Temp	9.001	R		T		°C
Humidity	Status_Humidity	2 bytes	DPT_Value_Humidity	9.007	R		T		%

8.5 Temperature sensor

FUNCTION	NAME	LENGTH	DATAPOINT TYPE		FLAGS				VALUES
			DPT_NAME	DPT_ID	R	W	T	U	
Temperature	Status_Temperature	2 bytes	DPT_Value_Temp	9.001	R		T		°C
Humidity	Status_Humidity	2 bytes	DPT_Value_Humidity	9.007	R		T		%

8.6 Heating actuators

TOPIC	NAME	LENGTH	DATAPOINT TYPE		FLAGS				FUNCTION
			DPT_NAME	DPT_ID	R	W	T	U	
Kieback &Peter Battery Powered / Thermokon Battery Powered	Status_ Current Position	1 byte	DPT_Scaling	5.001	R		T		%
	Status_ Service On/Off	1 bit	DPT_Switch	1.001	R		T		0 – Off; 1 - On
	Status_ Energy/Input Enabled	1 bit	DPT_Enable	1.003	R		T		0 – Disable; 1 – Enable
	Status_ Energy Storage. Changed	1 bit	DPT_Bool	1.002	R		T		0 – False; 1 - True
	Status_ Batory Capacity	1 bit	DPT_Alarm	1.005	R		T		0 – No alarm; 1 - Alarm
	Status_ Cover State	1 bit	DPT_OpenClose	1.009	R		T		0 – Open; 1 – Close
	Status_ Temperature Sensor Failure	1 bit	DPT_Bool	1.002	R		T		0 – False; 1 - True
	Status_ Window Contact	1 bit	DPT_Window_Door	1.019	R		T		0 - Closed; 1 - Open
	Status_ Actuator obstructed	1 bit	DPT_Bool	1.002	R		T		0 – False; 1 - True
	Status_ Temperature	2 bytes	DPT_Value_Temp	9.001	R		T		°C
	Control_ Poission Setpoint	1 byte	DPT_Scaling	5.001	R		T		%
	Control _ Temperature Setpoint	2 bytes	DPT_Value_Temp	9.001	R		T		°C
	Control _ Temperature RC	2 bytes	DPT_Value_Temp	9.001	R		T		°C
	Control _ Run Init Sequence	1 bit	DPT_Bool	1.002	R		T		0 – False; 1 - True
	Control _ Lift Set	1 bit	DPT_Bool	1.002	R		T		0 – False; 1 - True
	Control _ Valve Open	1 bit	DPT_Bool	1.002	R		T		0 – False; 1 - True
	Control _ Valve Close	1 bit	DPT_Bool	1.002	R		T		0 – False; 1 - True
Control _ Reduction of Energy Consumption	1 bit	DPT_Bool	1.002	R		T		0 – False; 1 - True	

Spartan	Control_ Setpoint Inverse	1 bit	DPT_Bool	1.002	R	T	0 – False; 1 - True
	Status_ Actual Value	1 byte	DPT_Scaling	5.001	R	T	%
	Status_ Setpoint Inverse	1 bit	DPT_Bool	1.002	R	T	0 – False; 1 - True
	Status_ Valve Position	1 byte	DPT_Scaling	5.001	R	T	%
	Status_ Temperature	2 bytes	DPT_Value_Temp	9.001	R	T	°C
	Control _ Position Setpoint	1 byte	DPT_Scaling	5.001	R	T	%
	Control _ Temperature Setpoint	2 bytes	DPT_Value_Temp	9.001	R	T	°C
	Control _ Temperature RC	2 bytes	DPT_Value_Temp	9.001	R	T	°C
	Control _ Setpoint Inverse	1 bit	DPT_Bool	1.002	R	T	0 – False; 1 - True
	Control _ Valve Setpoint	1 byte	DPT_Scaling	5.001	R	T	%
Temperature Control	Status_ Control Variable	1 byte	DPT_Scaling	5.001	R	T	%
	Status_ Fan Stage	1 byte	DPT_Scaling	5.001	R	T	%
	Status_ Fan Man/Auto	1 bit	DPT_Bool	1.002	R	T	0 – Man; 1 – Auto
	Status_ Setpoint Shift	2 bytes	DPT_Value_Tempd	9.002	R	T	°K
	Status_ Controller Mode Off/Auto	1 bit	DPT_Bool	1.002	R	T	0 – Off; 1 - Auto
	Status_ Controller Mode Cool/Heat	1 bit	DPT_Heat/Cool	1.100	R	T	0 – Cooling; 1 – Heating
	Status_ Controller Mode	1 byte	DPT_HVACContrMode	20.105	R	T	1 - Heat; 3 - Cool; 6 - Off
	Status_ Normal/Hold-off Stop	1 bit	DPT_Bool	1.002	R	T	0 – Normal; 1 – Hold-off
	Status_ Room Occupancy Frost	1 bit	DPT_Bool	1.002	R	T	0 – False; 1 - True
	Status_ Room Occupancy	1 bit	DPT_Occupancy	1.018	R	T	0 – Not occupied; 1 – Occupied
Status_ Room Occupancy Mode	1 byte	DPT_OccMode	20.003	R	T	HVAC Control Mode	

8.7 Humidity Sensors

TOPIC	NAME	LENGTH	DATAPOINT TYPE		FLAGS				FUNCTION
			DPT_NAME	DPT_ID	R	W	T	U	
Humidity	Status_ Humidity	2 bytes	DPT_Value_Humidity	9.007	R		T		%
	Status_ Humidity Setpoint	2 bytes	DPT_Value_Humidity	9.007	R		T		%
	Status_ Humidity	1 byte	DPT_Scaling	5.001	R		T		%
Temperature	Status_ Temperature	2 bytes	DPT_Value_Temp	9.001	R		T		°C
	Status_ Setpoint	1 byte	DPT_Scaling	5.001	R		T		°C
	Status_ Setpoint	2 bytes	DPT_Value_Temp	9.001	R		T		°C
Control	Status_ On/Off Button	1 bit	DPT_Switch	1.001	R		T		0 – Off; 1 - On
	Status_ Slide Switch	1 bit	DPT_Switch	1.001	R		T		0 – Off/Night/Pos1; 1 – On/Day/Pos0
Occupancy	Status_ Occupancy Button	1 bit	DPT_Occupancy	1.018	R		T		0 – Not occupied; 1 – Occupied
	Status_ Occupancy Enablement	1 bit	DPT_Enable	1.003	R		T		0 – Disable; 1 – Enable
Fan Speed	Status_ Fan Speed Manual/Auto	1 bit	DPT_Bool	1.002	R		T		0 – Man; 1 – Auto
	Status_ Fan Speed On/Off	1 bit	DPT_Switch	1.001	R		T		0 – Off; 1 - On
	Status_ Fan Speed Stage	1 byte	DPT_Scaling	5.001	R		T		%
	Status_ Fan Speed Stage	1 byte	DPT_Enumerated	5.010	R		T		1 - Speed 0; 2 - Speed 1; 3 Speed 2; ...; 6 Speed 5

8.8 Light Sensors

TOPIC	NAME	LENGTH	DATAPOINT TYPE		FLAGS				FUNCTION
			DPT_NAME	DPT_ID	R	W	T	U	
Illumination	Status_Illumination 1	2 bytes	DPT_Value_Lux	9.004	R		T		lux
	Status_Illumination 2	2 bytes	DPT_Value_Lux	9.004	R		T		lux
	Status_Illumination Setpoint	2 bytes	DPT_Value_Lux	9.004	R		T		lux
	Status_Illumination Over Range	1 bit	DPT_Bool	1.002	R		T		0 – False; 1 – True
Voltage	Status_Supply Voltage	2 bytes	DPT_Value_Volt	9.020	R		T		mV
	Status_Supply Voltage Error Code	1 byte	DPT_Enumerated	5.010	R		T		Error Code
Temperature	Status_Temperature	2 bytes	DPT_Value_Temp	9.001	R		T		°C
	Status_Setpoint	1 byte	DPT_Scaling	5.001	R		T		°C
	Status_Temperature Setpoint	2 bytes	DPT_Value_Temp	9.001	R		T		°C
Control	Status_On/Off Button	1 bit	DPT_Switch	1.001	R		T		0 – Off; 1 - On
	Status_Slide Switch	1 bit	DPT_Switch	1.001	R		T		0 – Off/Night/Pos1; 1 – On/Day/Pos0
Occupancy	Status_Occupancy Button	1 bit	DPT_Occupancy	1.018	R		T		0 – Not occupied; 1 – Occupied
	Status_Occupancy Enablement	1 bit	DPT_Enable	1.003	R		T		0 – Disable; 1 – Enable
	Status_Occupancy PIR	1 bit	DPT_Occupancy	1.018	R		T		0 – Not occupied; 1 – Occupied
Fan Speed	Status_Fan Speed Manual/Auto	1 bit	DPT_Bool	1.002	R		T		0 – Man; 1 – Auto
	Status_Fan Speed On/Off	1 bit	DPT_Switch	1.001	R		T		0 – Off; 1 - On
	Status_Fan Speed Stage	1 byte	DPT_Scaling	5.001	R		T		%

	Status_ Fan Speed Stage	1 byte	DPT_Enumerated	5.010	R		T		1 - Speed 1; 2 - Speed 2; 3 Speed 3; ...; 6 Speed 5
--	-------------------------	--------	----------------	-------	---	--	---	--	---

8.9 Metering

TOPIC	NAME	LENGTH	DATAPOINT TYPE		FLAGS				FUNCTION
			DPT_NAME	DPT_ID	R	W	T	U	
Electricity (AMR)	Status_Tariff Info	1 byte	DPT_Value_Temp	5.006	R		T		General
	Status_ Power W	4 bytes	DPT_Value_Power	14.056	R		T		Watts
	Status_ Active Energy	4 bytes	DPT_ActiveEnergy_kWh	13.013	R		T		KWh
Counter (AMR)	Status_ Counter	4 bytes	DPT_Value_4_Count	13.001	R		T		Counter
	Status_ Frequency	4 bytes	DPT_Value_Frequency	14.033	R		T		Hz
	Status_ Measurement Channel	1 byte	DPT_Enumerated	5.010	R		T		Enumeration
Gas (AMR)	Status_ Volume	4 bytes	DPT_Value_Volume	14.076	R		T		m ³
	Status_ Volume Flow	4 bytes	DPT_Value_Volume_Flux	14.077	R		T		m ³ /s
	Status_ Tariff info	1 byte	DPT_Value_Temp	5.006	R		T		Tariff info
Water (AMR)	Status_ Volume	4 bytes	DPT_Value_Volume	14.076	R		T		m ³
	Status_ Volume Flow	4 bytes	DPT_Value_Volume_Flux	14.077	R		T		m ³ /s
	Status_ Tariff info	1 byte	DPT_Value_Temp	5.006	R		T		Tariff info
Demand Respond	Status_ Temporary default	1 byte	DPT_Scaling	5.001	R		T		%
	Status_ Absolute/relative Power Usage	1 bit	DPT_Bool	1.002	R		T		0 – Absolute; 1 – Relative
	Status_ Power Usage	1 byte	DPT_Scaling	5.001	R		T		%
	Status_ Timeout Setting	2 bytes	DPT_Time_Period	7.007	R		T		Hours
	Status_ DR Level	1 byte	DPT_Enumerated	5.010	R		T		Counter
	Status_ Random Start Delay	1 bit	DPT_Bool	1.002	R		T		0 – Absolute; 1 – Relative

	Status_ Random End Delay	1 bit	DPT_Bool	1.002	R		T		0 – Absolute; 1 – Relative
	Status_ Min/Max Power Usage	1 bit	DPT_Bool	1.002	R		T		0 – Absolute; 1 – Relative

8.10 Occupancy Sensors

TOPIC	NAME	LENGTH	DATAPOINT TYPE		FLAGS				FUNCTION
			DPT_NAME	DPT_ID	R	W	T	U	
Illumination	Status_Illumination	2 bytes	DPT_Value_Lux	9.004	R		T		lux
Voltage	Status_Supply Voltage	2 bytes	DPT_Value_Volt	9.020	R		T		mV
Temperature	Status_Temperature	2 bytes	DPT_Value_Temp	9.001	R		T		°C
Control	Status_ On/Off Button	1 bit	DPT_Switch	1.001	R		T		0 – Off; 1 - On
Occupancy	Status_ Occupancy Button	1 bit	DPT_Occupancy	1.018	R		T		0 – Not occupied; 1 – Occupied
	Status_ Occupancy PIR	1 bit	DPT_Occupancy	1.018	R		T		0 – Not occupied; 1 – Occupied
	Status_ Occupancy	1 bit	DPT_Occupancy	1.018	R		T		0 – Not occupied; 1 – Occupied

8.11 Window and Door Sensors

TOPIC	NAME	LENGTH	DATAPOINT TYPE		FLAGS				FUNCTION
			DPT_NAME	DPT_ID	R	W	T	U	
Window Contact	Status_ Contact	1 bit	DPT_OpenClose	1.009	R		T		0 - Open; 1 - Closed
	Status_ Contact	1 bit	DPT_Window_Door	1.019	R		T		0 - Closed; 1 - Open
Window Door	Status_ Window Door	1 bit	DPT_Window_Door	1.019	R		T		0 – Close, 1 – Open

Window Ventilation	Status_Window Ventilation	1 bit	DPT_Bool	1.002	R		T		0 – False, 1 – True
---------------------------	---------------------------	-------	----------	-------	---	--	---	--	---------------------

8.12 Rocker Switch and Key Card

TOPIC	NAME	LENGTH	DATAPOINT TYPE		FLAGS				FUNCTION
			DPT_NAME	DPT_ID	R	W	T	U	
Button	Status_Button X ⁵ - Switching	1 bit	DPT_Switch	1.001	R		T		0 – Off; 1 - On
	Status_Button X ⁵ - Dimming - On/Off	1 bit	DPT_Switch	1.001	R		T		0 – Off; 1 - On
	Status_Button X ⁵ - Dimming – Step	4 bits	DPT_Control_Dimming	3.007	R		T		%
	Status_Button X ⁵ – Shutter/Blind – Step	1 bit	DPT_UpDown	1.008	R		T		0 – Step Up; 1 – Step Down
	Status_Button X ⁵ – Shutter/Blind - Move	1 bit	DPT_UpDown	1.008	R		T		0 – Move Up; 1 – Move Down
Channel	Status_Channel Y ⁶ - Switching	1 bit	DPT_Switch	1.001	R		T		0 – Off; 1 - On
	Status_Channel Y ⁶ - Dimming - On/Off	1 bit	DPT_Switch	1.001	R		T		0 – Off; 1 - On
	Status_Channel Y ⁶ - Dimming – Step	4 bits	DPT_Control_Dimming	3.007	R		T		%
	Status_Channel Y ⁶ – Shutter/Blind – Step	1 bit	DPT_UpDown	1.008	R		T		0 – Step Up; 1 – Step Down
	Status_Channel Y ⁶ – Shutter/Blind - Move	1 bit	DPT_UpDown	1.008	R		T		0 – Move Up; 1 – Move Down
Key Card	Status_Key Card Inserted	1 bit	DPT_Bool	1.002	R		T		0 – False; 1 - True

8.13 Room Operating Panel

⁵ X indicates the button index

⁶ Y indicates the channel index

TOPIC	NAME	LENGTH	DATAPOINT TYPE		FLAGS				FUNCTION
			DPT_NAME	DPT_ID	R	W	T	U	
Temperature	Status_Temperature	2 bytes	DPT_Value_Temp	9.001	R		T		°C
	Status_Temperature Setpoint	2 bytes	DPT_Value_Temp	9.001	R		T		°C
	Status_Setpoint	1 byte	DPT_Scaling	5.001	R		T		%
	Status_Setpoint	2 bytes	DPT_Value_Temp	9.001	R		T		°C
Humidity	Status_Humidity	2 bytes	DPT_Value_Humidity	9.007	R		T		%
	Status_Humidity	1 byte	DPT_Scaling	5.001	R		T		%
	Status_Humidity Setpoint	2 bytes	DPT_Value_Humidity	9.007	R		T		%
Illumination	Status_Illumination	2 bytes	DPT_Value_Lux	9.004	R		T		lux
	Status_Illumination Setpoint	2 bytes	DPT_Value_Lux	9.004	R		T		lux
	Status_Illumination Over Range	1 bit	DPT_Bool	1.002	R		T		0 – False; 1 – True
Control	Status_On/Off Button	1 bit	DPT_Switch	1.001	R		T		0 – Off; 1 - On
	Status_Slide Switch	1 bit	DPT_Switch	1.001	R		T		0 – Off/Night/Pos1; 1 – On/Day/Pos0
Occupancy	Status_Occupancy Button	1 bit	DPT_Occupancy	1.018	R		T		0 – Not occupied; 1 – Occupied
	Status_Occupancy Enablement	1 bit	DPT_Enable	1.003	R		T		0 – Disable; 1 – Enable
Contact	Status_Contact State	1 bit	DPT_OpenClose	1.009	R		T		0 - Open; 1 - Closed
	Status_Contact State	1 bit	DPT_Window_Door	1.019	R		T		0 - Closed; 1 - Open
Fan Speed	Status_Fan Speed Manual/Auto	1 bit	DPT_Bool	1.002	R		T		0 – Manual; 1 - Auto
	Status_Fan Speed	1 byte	DPT_Scaling	5.001	R		T		%
	Status_Fan Speed	1 byte	DPT_Enumerated	5.010	R		T		0-Position 0; 1-Position 1; 2-Position 2; 3-Position 3
	Status_Fan Speed Stage	1 byte	DPT_Scaling	5.001	R		T		%

	Status_ Fan Speed Stage	1 byte	DPT_Enumerated	5.010	R		T		1 - Speed 1; 2 - Speed 2; 3 Speed 3; ...; 6 Speed 5
Voltage	Status_Supply Voltage	2 bytes	DPT_Value_Volt	9.020	R		T		mV
	Status_Supply Voltage Error Code	1 byte	DPT_Enumerated	5.010	R		T		Error Code

9 Appendix A – EnOcean interoperability (EEP)

9.1 ABB supported EEPs

EEP	EEP ⁷ description
[F6-02-xx]	Light and Blind Control
[F6-03-xx]	Light and Blind Control
[F6-04-01]	Position Switch, Home and Office Application (Key Card Activated Switch)
[F6-10-00]	Mechanical Handle
[D5-00-01]	Contacts and Switches
[A5-02-xx]	Temperature sensors
[A5-04-01]	Temperature and Humidity Sensor
[A5-06-xx]	Light Sensor
[A5-07-xx]	Occupancy Sensor
[A5-08-xx]	Light, Temperature and Occupancy Sensor
[A5-09-xx]	Gas Sensor
[A5-10-xx]	Room Operating Panel
[A5-11-xx]	Controller Status
[A5-12-00]	Automated meter Reading (AMR)
[A5-20-xx]	HVAC Components ⁸
[A5-30-xx]	Digital Input
[A5-37-xx]	Energy Management
[A5-38-xx]	Central Command

⁷ EnOcean Equipment Profiles (EEP) v2.1

⁸ The gateway can replace the controllers of the HVAC Components, but not the EnOcean devices themselves.

10 Appendix B - KNX/EnOcean Gateway HMI

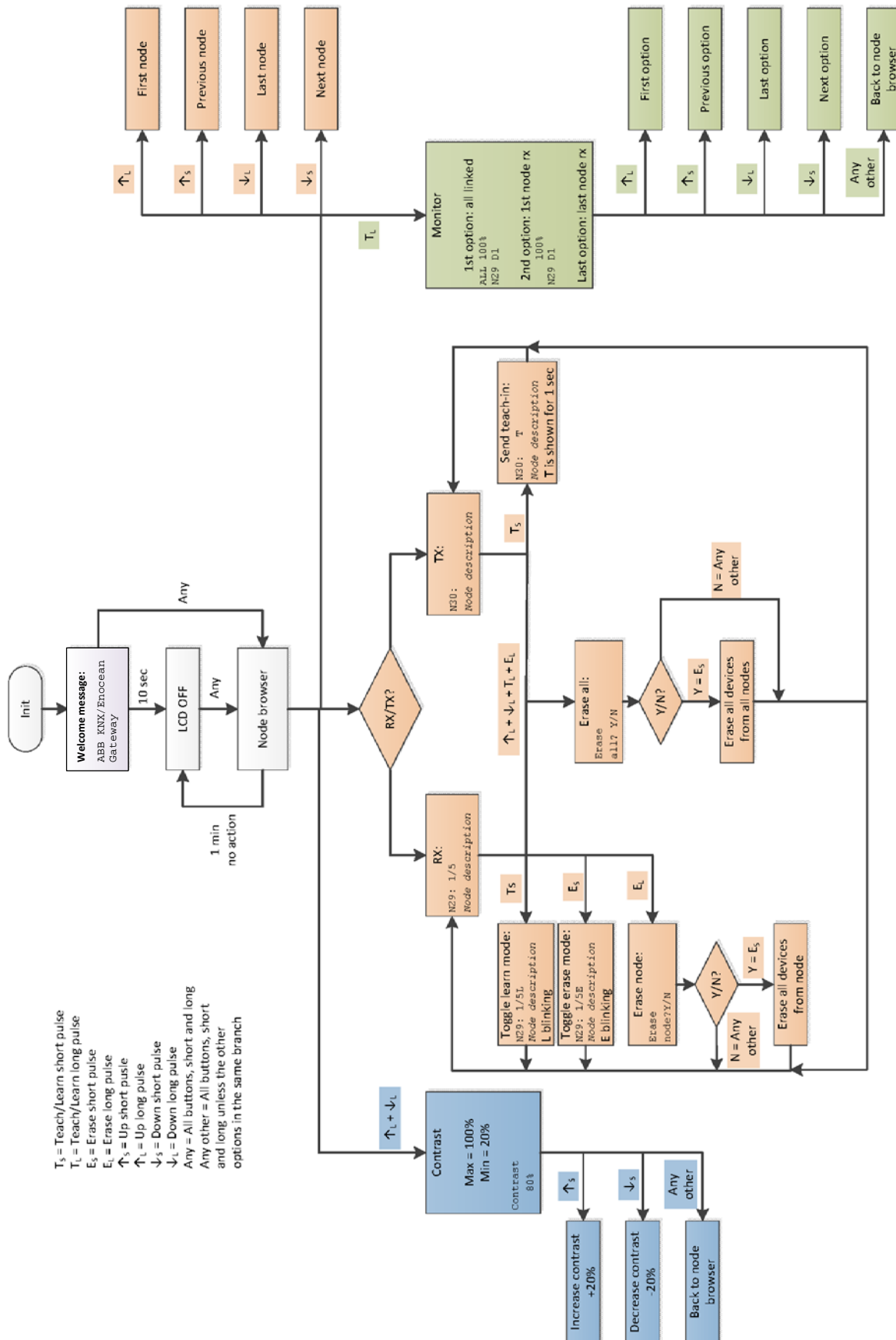

Contact

ABB STOTZ-KONTAKT GmbH

Eppelheimer Strasse 82

69123 Heidelberg, Germany

Phone: +49 (0)6221 701 607 (Marketing)

Fax: +49 (0)6221 701 724

e-mail: knx.marketing@de.abb.com

Additional information and contact partners:

www.abb.com/knx

Note:

We reserve the right to make technical changes or modify the contents of this document without prior notice.

With regard to purchase orders, the agreed particulars shall prevail. ABB AG does not accept any responsibility whatsoever for potential errors or possible lack of information in this document.

We reserve all rights in this document and in the subject matter and illustrations contained therein. Any reproduction, disclosure to third parties or utilization of its contents – in whole or in parts – is forbidden without prior written consent of ABB AG.

Copyright© 2014 ABB

All rights reserved