

ABB i-bus[®] KNX Light Controller with Sensor LR/S with LF/U

Intelligent Installation Systems



This manual describes the function of the Light Controller LR/S x.16.1 with the corresponding Light Sensor LF/U 2.1 with the application program *Control Dim xf 1-10V/1.0* (x = 2 and 4 outputs).
Subject to changes and errors excepted.

Exclusion of liability:

Despite checking that the contents of this document match the hardware and software, deviations cannot be completely excluded.
We therefore cannot accept any liability for this.
Any necessary corrections will be inserted in new versions of the manual.
Please inform us of any suggested improvements.

Contents		Page
1	General	3
1.1	Product and functional overview.....	4
1.2	Properties of the 1-10 V interface.....	5
2	Device technology	7
2.1	Light Controller LR/S x.16.1.....	7
2.1.1	Technical data.....	7
2.1.2	Connection schematics.....	12
2.1.3	Dimension drawings.....	13
2.2	Light Sensor LF/U 2.1.....	14
2.2.1	Technical data.....	14
2.2.2	Connection schematics.....	16
2.2.3	Dimension drawing.....	17
2.2.4	Polar diagram.....	18
2.3	Assembly and installation.....	19
2.4	Description of the inputs and outputs.....	20
2.5	Special operation states.....	20
2.6	Assignment of the physical address of a KNX device.....	21
2.7	Checking Light Sensor LF/U 2.1.....	21
2.8	Manual operation.....	21
2.9	Supplied state.....	22
2.10	Maintenance and cleaning.....	22
3	Commissioning	23
3.1	Overview.....	23
3.2	Parameters.....	26
3.2.1	Parameter window <i>General</i>	27
3.2.2	Parameter window <i>Light sensor</i>	30
3.2.3	Parameter window <i>X: General</i>	33
3.2.4	Parameter window <i>X: Function</i>	39
3.2.5	Parameter window <i>X: Switch</i>	44
3.2.6	Parameter window <i>X: Dimming</i>	46
3.2.7	Parameter window <i>X: Value</i>	49
3.2.8	Parameter window <i>X: Presets</i>	51
3.2.9	Parameter window <i>X: Scene (1) to X: Scene (6)</i>	54
3.2.10	Parameter window <i>X: Charact. adj.</i>	57
3.2.11	Parameter window <i>X: Control</i>	59
3.2.12	Parameter window <i>X: Control Dynamics</i>	69
3.2.13	Parameter window <i>X: Control Operating</i>	72
3.2.14	Parameter window <i>X: Slave</i>	76
3.2.15	Parameter window <i>X: Staircase light</i>	80
3.3	Communication objects.....	83
3.3.1	General.....	83
3.3.2	Per output.....	84
3.3.3	Per output for function <i>Preset</i>	89
3.3.4	Per output for function <i>8 bit scene</i>	90
3.3.5	Per output for function <i>Block</i>	91
3.3.6	Per output for function <i>Light control</i>	92
3.3.7	Per output for function <i>Slave mode</i>	96
3.3.8	Per output for function <i>Staircase light</i>	97
3.3.9	Per output for the <i>Diagnostics</i>	98

4	Planning and application	101
4.1	Number of connectable ballasts.....	101
4.1.1	Load current influence.....	102
4.1.2	Control current influence.....	103
4.2	Function chart.....	104
4.3	Staircase lighting time.....	105
4.4	Preset description.....	108
4.5	8 bit scene.....	110
4.6	Characteristic adjustment.....	112
4.6.1	Differing light strips.....	113
4.7	Constant lighting control.....	116
4.7.1	Constant lighting control properties.....	118
4.7.2	Positioning of the Light Sensor.....	121
4.7.3	Commissioning/calibration of the constant lighting control.....	122
4.7.4	Effect of ageing on lamps.....	129
4.7.5	How does brightness detection function.....	130
4.7.6	Function of the constant lighting control.....	130
4.8	Slave mode.....	134
4.9	Behaviour with bus voltage failure, recovery, download and ETS reset.....	135
4.10	Interdependence of the functions.....	139
A	Appendix	141
A.1	Table for the <i>Status byte</i> object.....	141
A.2	Code table 8 bit scene telegram.....	141
A.3	Table for the object <i>Status function</i>	143
A.4	Terminology in lighting technology.....	144
A.4.1	Lighting intensity.....	144
A.4.2	Light density.....	145
A.5	Energy efficiency potential with domestic and intelligent installation systems.....	146
A.6	LR/S x.16.1 scope of delivery.....	147
A.7	LF/U 2.1 scope of delivery.....	147
A.8	Ordering information.....	148

1 General

This manual provides you with detailed technical information relating to the ABB i-bus[®] Light Controller LR/S x.16.1 (1-10 V) and the corresponding Light Sensor LF/U 2.1. Mounting, programming, commissioning and application of the devices is explained using examples.

Constant lighting control will:

- Reduce operating costs
- Save energy
- Guarantee an optimum working environment at constant brightness
- Provide enhanced lighting comfort in day-to-day operation

The application program offers a range of independent functions for each output:

- Switching, dimming, setting of brightness values
- Use of different dimming speeds
- Status feedback
- Master/slave operation of other illumination components
- Master/slave control with internal lighting controller
- Staircase lighting including prewarnings
- Scene and preset functions
- Blocked functions and forced operation
- Simplified light controller commissioning through two calibration points

The Light Controller can – in addition to the direct control of electronic ballasts with 1-10V interfaces – be introduced as a master in a KNX lighting system which integrates a wide range of components, e.g. ABB i-bus[®] Switch/Dim Actuators SD/S, DALI Gateways DG/S or Universal Dim Actuators UD/S, into an energy efficient constant lighting control system.

The occupancy is also automatically detected in addition to lighting control via a KNX presence detector, an above average energy saving potential can also be achieved alone using KNX lighting technology. The following graphic provides an overview of the energy which can be saved by the use of modern, automatic intelligent installation systems.

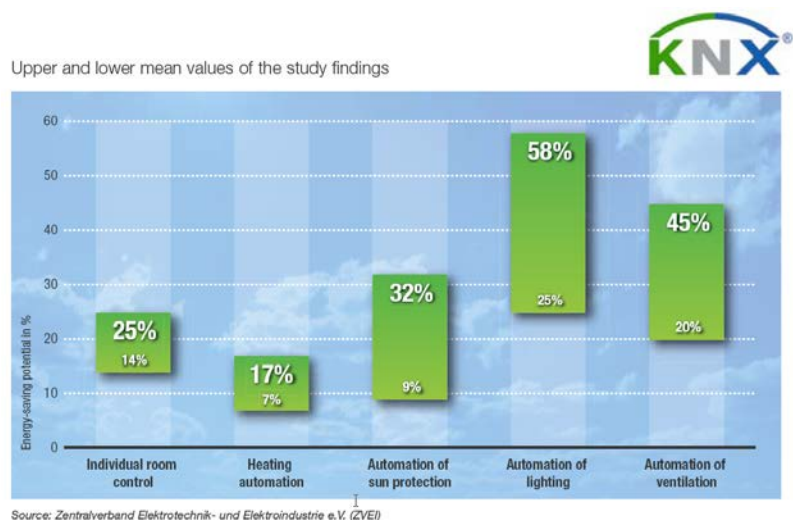

1.1 Product and functional overview



LR/S 4.16.1

LR/S 2.16.1

LF/U 2.1

Both Light Controllers LR/S 2.16.1 and LR/S 4.16.1 are modular installation devices in ProM Design. They control dimmable electronic ballasts or transformers with 1-10 V interface via 2 or 4 outputs. For every output a floating 16 A switching contact for switch on and off of the ballasts is available.

The outputs can be programmed independently of one another. Functions, e.g. dimming, switching, scene recalls, light control, staircase lighting and slave operation are available individually for each output.

Four (LR/S 4.16.1) or two (LR/S 2.16.1) Light Sensors LF/U 2.1 can be connected to the Light Controller. The Light Sensor LF/U 2.1 is specially matched to the Light Controller. Depending of the predefined brightness target values, the Light Controller can control up to four lighting circuits which are independent of each other. It is possible to combine the sensor values from several Light Sensors for the calculation of an individual control circuit. In this way a constant lighting control can also be implemented in areas with difficult lighting conditions.

The brightness value calculated for the constant lighting control via the Light Controller (master) can be transferred on the KNX or directly in the device on another output. Further components of the KNX lighting system (slaves), e.g. ABB i-bus® Switch/Dim Actuators SD/S and DALI Gateways DG/S, can thus be integrated into an energy efficient constant lighting control.

Rooms are lit up differently by the incidental daylight and the artificial lighting of the lamps. However not all surfaces in the rooms, e.g. walls, floor, and furniture reflect the light which falls on them in the same manner.

Accordingly, even though there is an exactly calibrated constant lighting control in daily operation, deviations to the set target value may occur. These deviations can be up to +/-100 lx. Usually the differences result due to changed ambient conditions in the room, new or moved furniture, persons or paper.

Hereby, the reflection properties of the surfaces can differ significantly from the original ambient conditions at the time of calibration. Deviations may also occur if the Light Sensor is influenced by direct or reflected light falling on it.

The Light Controller and the connected Light Sensor are supplied with power via the KNX and do not require any additional power supply. The control voltage of the 1-10 V devices is generated by the ballasts.

The Light Controller acts against this control voltage and reduces it. This is used to set the required dimming value. Switch off is implemented via the integrated switching relay in the Light Controller.

The setting of the parameters, allocation of the group addresses and commissioning is implemented with the Engineering Tool Software ETS. The minimum requirement is version ETS2 V1.3. Preferably the most up-to-date version should be used.

Important

The Light Sensor of type LF/U 1.1 is not suitable for use on the Light Controllers LR/S 2.16.1 or LR/S 4.16.1.

1.2 Properties of the 1-10 V interface

Dimmable ballast's with 1-10 V control interface have long been established on the market and offer a simple, reliable and attractively priced solution for implementing controlled lighting environments, mood illumination and energy saving lighting installations.

Properties of the 1-10 V lighting systems

- Control of the ballast's is implemented via an interference resistant DC voltage signal of 10 V where:
 1. 10 V = maximum brightness (open control line) and,
 2. 1 V = minimum brightness (control line fully loaded).
- The 10 V DC control voltage is supplied from the ballast's. The maximum supply current is dependent on the ballast type and manufacturer and lies typically between 0.5 mA and 4 mA per ballast.
- The control voltage is potentially isolated from the mains supply voltage, however it is not classified as SELV (**S**afety **E**xtra-**L**ow **V**oltage).
- Ballast devices connected to different phases can be dimmed with the same control voltage, i.e., control line.

Due to the typical characteristics of the 1-10 V system, the following points must be observed:

- The polarity of the control lines and of the control voltage must be observed.
- The control voltage is potentially isolated from the mains supply voltage, however as the voltage is not SELV, in the event of a fault, mains voltages can be present.
- The control voltage can be limited to a maximum or minimum value via the control device, e.g., the Switch/Dimm Actuators SD/S. This allows the implementation of two useful features:
 1. Setting a minimum value allows trouble-free ignition of lamps at low light levels.
 2. Limiting the upper value can save significant energy in normal operation and can extend the useful service life of the fluorescent tubes or allow for future compensation due to ageing of the luminaries.
- Testing the correct function of a ballast can be easily done without the need for additional software or testing devices:
 1. The ballast is turned on with an open circuit control line. The luminaire should ignite at full intensity.
 2. Short-circuiting the control line, e.g., with a wire jumper (observe second point!). The lamp should now dim down to the minimum brightness.

- The 1-10 V control voltage is purely used for dimming the ballast's. The devices remain under mains voltage, even at minimum brightness. Isolation of the ballasts is carried out via the switch contact in the control device.
- The maximum loading of the control device must be observed:
 1. Loading of the 1-10 V control line.
 2. Maximum switching capacity of the output circuit, including consideration of in-rush currents.

2 Device technology

2.1 Light Controller LR/S x.16.1



2CDC 071 023 F0008

LR/S 4.16.1

The ABB i-bus® Light Controllers, LR/S x.16.1 (x = 2 or 4) are KNX modular installation devices (MDRC) in ProM Design for installation in the distribution board on 35 mm mounting rails. The connection to the ABB i-bus® is implemented via a bus connection terminal on the device shoulders.

The LR/S can control dimmable electronic ballasts or transformers with a 1-10 V interface via two or four outputs – depending on the device concerned.

For every output a floating switching contact (16 A) for direct switch on and off of the ballasts are available. The switching relays are particularly suitable for switching fluorescent lamp loads (AX) to DIN EN 60 669.

Manual switch ON and OFF of the individual outputs is possible in manual control independently of the bus or auxiliary voltages. The operating element on the switching relay directly indicates the switch status.

A separate Light Sensor LF/U 2.1 can be separately connected on the Light Controller for each output. The light sensor measures brightness in closed rooms. The Light Controller undertakes constant light control for each output (control circuit) with this brightness value. It is possible to use several Light Sensors for a single output.

The Light Controller and the connected Light Sensor are supplied with power via the KNX and do not require any additional power supply.

2.1.1 Technical data

Supply	Operating voltage	21...30 V DC, made available by the bus	
	Power consumption via KNX	Maximum 250 mW	
	Current consumption KNX	2.16.1	4.16.1
	Maximum	8.5 mA	10 mA
Outputs control circuit	LR/S type	2.16.1	4.16.1
	Number of control outputs 1-10 V (passive)	2	4
	Maximum current per control output	100 mA	100 mA
	Maximum number of ballasts (2 mA/ballast) ¹⁾	50	50
	Maximum cable length with maximum load (100 mA)	70 m with cable cross-section 0.8 mm ²	100 m with cable cross-section 1.5 mm ²
Sensor input	LF/U 2.1 ²⁾		
	Number of inputs	2 with LR/S 2.16.1 or 4 with LR/S 4.16.1	
	Maximum cable length per sensor	Per sensor 100 m, Ø 0.8 mm, P-YCYM or J-Y(ST)Y cable (SELV), e.g. shielded KNX bus cable	

Brightness detection	Lighting control operating range	Optimised for 500 Lux. 200...1200 Lux for rooms with average furnishing level degree of reflection 0.5 max. 860 Lux in a very brightly furnished room (reflection 0.7) max. 3000 Lux in a very darkly furnished room (reflection 0.2) The Lux values are measured values on the work surface (reference surface) ³⁾	
	Optimum installation height	2-3 m	
Outputs load circuit rated values	LR/S type	2.16.1	4.16.1
	Number of load outputs (floating)	2	4
	U _n rated voltage	250/440 V AC (50/60 Hz)	
	I _n rated current	16 A AC1 or 10 AX	
	Leakage loss per device at max. load	2.6 W	5.2 W
Load circuit (relay) switching currents	AC1* operation (cos φ = 0.8) DIN EN 60 947-4-1	16 A/230 V	
	Fluorescent lighting load AX to DIN EN 60 669-1	10 AX/250 V (140 μF) ⁴⁾	
	AC3* operation (cos φ = 0.6) DIN EN 60 947-4-1	8 A/230 V	
	Minimum switching performance	100 mA/12 V 100 mA/24 V	
	DC current switching capacity (resistive load)	10 A/24 V =	
	Lamp loads	See table Lamp loads	
Load circuit (relay) service life	Mechanical service life	> 3 x 10 ⁶	
	Electronic service life to AC1* (240 V/cos φ = 0.8)	DIN IEC 60 947-4-1 > 10 ⁵	
	AC5a* (240 V/cos φ = 0.45)	> 3 x 10 ⁴	
Load circuit (relay) switching times	LR/S type	2.16.1	4.16.1
	Maximum relay position change per output and minute if all relays are switched simultaneously. The position changes should be distributed equally over the minute.	60	30
	Maximum relay position change per output and minute if only one relay is switched.	120	120
Connections ABB i-bus®	KNX bus connection terminal	0.8 mm Ø, single core	
Connections control circuit	Screw terminal with slotted screw	0.2...2.5 mm ² stranded	
		0.2...4 mm ² solid	
Connections light sensor LF/U 2.1	Ferrules without/with plastic sleeves	Without 0.25...2.5	with 0.25...4 mm ²
	TWIN ferrules	0.5...2.5 mm ²	
	Tightening torque	Maximum 0.6 Nm	
Connections load circuit	Screw terminal with universal head (PZ 1)	0.2...4 mm ² stranded, 2 x (0.2-2.5 mm ²)	
	ferrules without/with plastic sleeves	0.2...6 mm ² solid, 2 x (0.2-4 mm ²)	
	TWIN ferrules	Without 0.25...2.5	with 0.25...4 mm ²
	Tightening torque	0.5...2.5 mm ² Maximum 0.8 Nm	

Operating and display elements	Red LED and KNX button Switch position display	For assignment of the physical address Relay operator
Enclosure	IP 20	To DIN EN 60 529
Safety class	II	To DIN EN 61 140/IEC 536
Isolation category	Overvoltage category Pollution degree	III to DIN EN 60 664-1 2 to DIN EN 60 664-1
KNX safety extra low voltage	SELV 24 V DC	
Temperature range	Operation Storage Transport	-5 °C ...+45 °C -25 °C...+55 °C -25 °C...+70 °C
Environmental conditions	Humidity	Maximum 93 %, moisture condensation should be excluded
Design	Modular installation device (MDRC) LR/S type Dimensions (H x W x D) Width W in mm Mounting width (modules at 18 mm)	Modular installation device, ProM 2.16.1 4.16.1 90 x W x 64.5 72 108 4 6
Weight	in kg	0.200 0.330
Installation	On 35 mm mounting rail	DIN EN 60 715
Mounting position	as required	
Housing, colour	Plastic housing, grey	
Approvals	KNX to EN 50 090-2-2	Certification
CE mark	in accordance with the EMC guideline and low voltage guideline	

¹⁾ The control current of 1-10 V devices determine the number of connectable ballast devices. Typical devices are between 0.4...4 mA.

²⁾ Note: LF/U 1.1 not suitable

³⁾ Rooms are lit up differently by the incidental daylight and the artificial lighting of the lamps. Not all surfaces in the rooms, e.g. walls, floor, and furniture reflect the light which falls on them in the same manner. Accordingly, even though there is an exactly calibrated constant lighting control in daily operation, deviations to the set target value may occur. These deviations may be up to +/- 100lx should the current ambient conditions in the room, and accordingly the reflection properties of the surfaces (paper, persons, reorganized or new furniture), differ significantly from the original ambient conditions at the time of calibration. Deviations may also occur if the Light Sensor is influenced by direct or reflected light falling on it which is not influenced or only slightly influenced by the surfaces in the detection range of the Light Sensor.

⁴⁾ The maximum inrush-current peak (see table [Lamp loads](#)) may not be exceeded

⁵⁾ The specifications apply only after the bus voltage has been applied to the device for at least 30 seconds.
Typical delay of the relay is approx. 20 ms.

* What do the terms AC1, AC3 and AC5a mean?

In Intelligent Installation Systems different switching capacity and performance specifications which are dependent on the special application have become established in industrial and residential systems. These performance specifications are rooted in the respective national and international standards. The tests are defined so that typical applications, e.g. motor loads (industrial) or fluorescent lamps (residential) are simulated.

The specifications AC1 and AC3 are switching performance specifications which have become established in the industrial field.

Typical application:

AC1 – Non-inductive or slightly inductive loads, resistive furnaces (relates to switching of ohmic/resistive loads)

AC3 – Squirrel-cage motors: Starting, switching off motors during running (relates to (inductive) motor load)

AC5a – Switching of electric discharge lamps

These switching performances are defined in the standard DIN EN 60947-4-1 *Contactors and motor-starters - Electromechanical contactors and motor-starters*. The standard describes starter and/or contactors which previously preferably used in industrial applications.

Lamp loads, switching powers for lamp circuit

Lamps	Incandescent lamp load	2300 W
Fluorescent lamp T5 / T8	Uncorrected	2300 W
	Parallel compensated	1500 W
	DUO circuit	1500 W
Low-volt halogen lamps	Inductive transformer	1200 W
	Electronic transformer	1500 W
	Halogen lamp 230 V	2300 W
Dulux lamp	Uncorrected	1100 W
	Parallel compensated	1100 W
Mercury-vapour lamp	Uncorrected	2000 W
	Parallel compensated	2000 W
Switching performance (switching contact)	Maximum peak inrush-current I_P (150 μ s)	400 A
	Maximum peak inrush-current I_P (250 μ s)	320 A
	Maximum peak inrush-current I_P (600 μ s)	200 A
Number of electronic ballasts (T5/T8, single element)¹⁾	18 W (ABB EVG 1 x 58 CF)	23
	24 W (ABB EVG-T5 1 x 24 CY)	23
	36 W (ABB EVG 1 x 36 CF)	14
	58 W (ABB EVG 1 x 58 CF)	11
	80 W (Helvar EL 1 x 80 SC)	10

¹⁾ For multiple element lamps or other types the number of electronic ballasts must be determined using the peak inrush current of the electronic ballasts.

Example see: [Planning and application](#)

**Caution**

The connection of a 230 V mains voltage supply to one of the 1-10 V outputs or sensor inputs leads to the destruction of the 1-10 V end stage or the corresponding sensor input.

Control and load ends are electrically isolated from the KNX.

The individual relays are potential free (floating). When connecting the control line it is important to consider that the control outputs each feature a common reference ground with one another.

Several electronic ballasts with a 1-10 V interface can be controlled by one output of the Light Controller.

The number of dimmable ballasts per output is limited both by the switching and the control powers of the Light Controller.

For calculation example see: [Planning and application](#)

User programs

Application program	Number of Communication objects	Max. number of group addresses	Max. number of associations
Control Dim 2f 1-10V/1	62	254	255
Control Dim 4f 1-10V/1	118	254	255

Note

The programming requires ETS2 V1.3 or higher.

If ETS3 is used a *.VD3 or higher type file must be imported.

The application program for the ETS2/ETS3 can be found at ABB/Lighting Devices/Illumination and Light Sensors/*Control Dim xf 1-10V/1*, (x = 2 or 4, number of outputs).

The devices do not support the closing function of a project or the KNX devices in the ETS. If you inhibit access to all devices of the project with a *BA password* (ETS2) or a *BCU code* (ETS3), it has no effect on this device.

Data can still be read and programmed.

2.1.2 Connection schematics

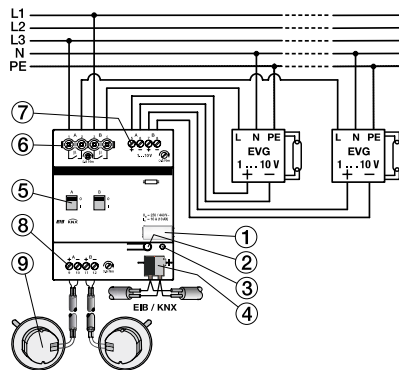

LR/S 2.16.1

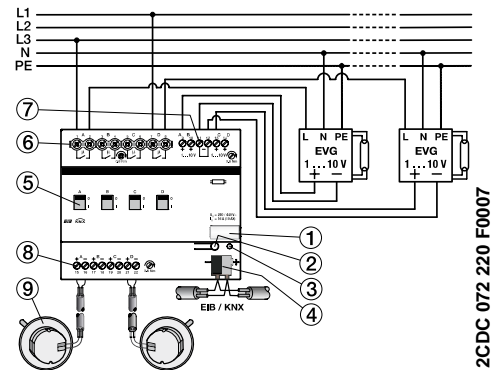

LR/S 4.16.1

- | | |
|-------------------------------------------------------|---------------------------------------------------|
| 1 Label carrier | 6 Load circuit, for each 2 screw terminals |
| 2 KNX programming button terminals | 7 Control circuits 1-10 V, for each 2 screw |
| 3 Red KNX programming LED | 8 Light Sensor inputs, for each 2 screw terminals |
| 4 KNX connection terminal | 9 Light sensor LF/U 2.1 |
| 5 Switch position display and ON/OFF manual actuation | |



Caution

All-pole disconnection must be observed in order to avoid dangerous touch voltages which originate from feedback of differing phase conductors.

Important

An open 1-10 V control line produces the maximum ballast brightness. A short circuited control line generates the minimum dimming value. The minimum dimming value is also set if the control cable polarity is reversed. In all three cases dimming of the lighting is not possible.

Note

An open Light Sensor cable (maximum cable resistance) means the same as a dark room for the Light Controller. The 1-10 V output is controlled with maximum brightness during control. The same behaviour is also exhibited with a short circuit and if the sensor cable polarity is reversed. The sensor value can be read via the object *Sensor value* (No. 32, 57, 82 or 107) of the corresponding output (L flag must be set!). This value corresponds with the measured value on the sensor input, the Light Sensor detects the luminance within its detection range. The value does not comply with the lighting intensity in Lux measured with a Luxmeter underneath the Light Sensor.

In all three fault scenarios (open circuit, short circuit and incorrect polarity) the value read via the object *Sensor value* is equal to 0. This value corresponds with the value of absolute darkness.

2.1.3 Dimension drawings

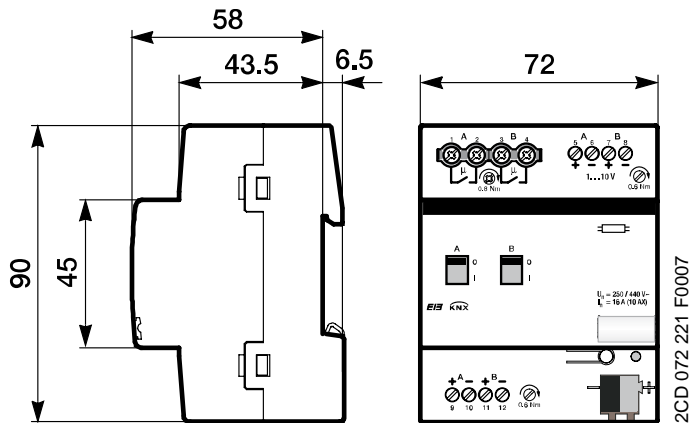

LR/S 2.16.1

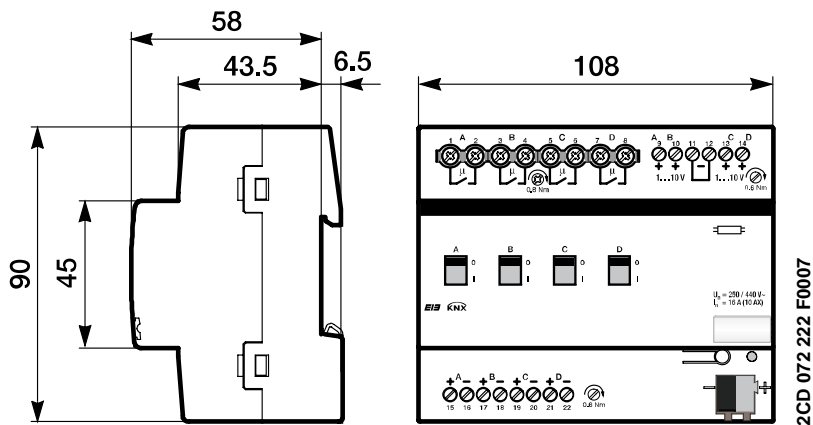

LR/S 4.16.1

Dimensions

	LR/S 2.16.1	LR/S 4.16.1
Width	72 mm	108 mm
MW	4 space units	6 space units

* MW = module width

2.2 Light Sensor LF/U 2.1



LF/U 2.1

2CD071 018 F0008

The ABB i-bus® light sensor LF/U 2.1 is a brightness sensor for closed rooms. The light sensor is mounted in a standard installation box in the ceiling. The cover (white) of the sensor is stuck firmly onto the device. The complete unit is then screwed into a flush-type box.

On the Light Controller LR/S x.16.1 (x = 2 or 4) up to two or four Light Sensors LF/U 2.1 can be connected. The light sensor measures brightness values in closed rooms. When combined with the detected values, the Light Controller is used for constant light control. It is possible to combine the brightness values from several Light Sensors for the calculation of an individual control circuit. It is thus possible to achieve control of the lighting in rooms with difficult lighting conditions.

The electrical connection to the Light Sensor on the Light Controller is carried out with a twin core MSR cable (SELV), e.g. KNX bus cable. The total length of this cable may not exceed 100 m.

The Light Sensor is supplied with a Plexiglas rod which snaps into the sensor housing. The registration area can be limited using the Plexiglas rod with the white coating.

The Light Controller and the connected Light Sensor are supplied with power via the KNX and do not require any additional auxiliary power supply.

2.2.1 Technical data

Supply	SELV	via LR/S x.16.1 (x = 2 or 4)
Connections	to LR/S x.16.1 ¹⁾	1 connecting terminal white/yellow (connecting terminals are supplied with the device)
	Max. cable length per sensor	Per sensor 100 m, Ø 0.8 mm, P-YCYM or J-Y(ST)Y cable (SELV), e.g. shielded KNX bus cable
Brightness detection	Lighting control operating range	Optimised for 500 Lux. 200...1200 Lux for rooms with average furnishing level degree of reflection 0.5 max. 860 Lux in a very brightly furnished room (reflection 0.7) max. 3000 Lux in a very darkly furnished room (reflection 0.2) The Lux values are measured values on the work surface (reference surface) ²⁾
	Optimum installation height	2-3 m
Enclosure	IP 20	to DIN EN 60 529
Safety class	II	to DIN EN 61 140
Isolation category	Overvoltage category	III to DIN EN 60 664-1
	Pollution degree	2 to DIN EN 60 664-1

Temperature range	Operation	-5 °C ...+45 °C
	Storage	-25 °C...+55 °C
	Transport	-25 °C...+70 °C
Environmental conditions	Humidity	Maximum 93 %, moisture condensation should be excluded
Design	Flush mounted device	For installation in 60 mm flush mounted box
	Dimensions	54 x 20 (Ø x H)
Weight	in kg	0,04
Mounting position	as required	
Housing, colour	Plastic housing, grey	
Approvals	KNX to EN 50 090-2-2	Certificate, in conjunction with LR/S x.16.1
CE mark	in accordance with the EMC guideline and low voltage guideline	

¹⁾ Note: Not suitable for Light Controller LR/S 2.2.1 and Light Controller Module LR/M 1.6.1

²⁾ Rooms are lit up differently by the incidental daylight and the artificial lighting of the lamps. Not all surfaces in the rooms, e.g. walls, floor, and furniture reflect the light which falls on them in the same manner. Accordingly, even though there is an exactly calibrated constant lighting control in daily operation, deviations to the set target value may occur. These deviations may be up to +/- 100lx should the current ambient conditions in the room, and accordingly the reflection properties of the surfaces (paper, persons, reorganized or new furniture), differ significantly from the original ambient conditions at the time of calibration. Deviations may also occur if the Light Sensor is influenced by direct or reflected light falling on it which is not influenced or only slightly influenced by the surfaces in the detection range of the Light Sensor.

2.2.2 Connection schematics

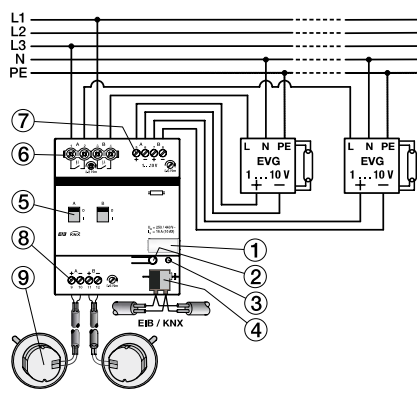

LR/S 2.16.1

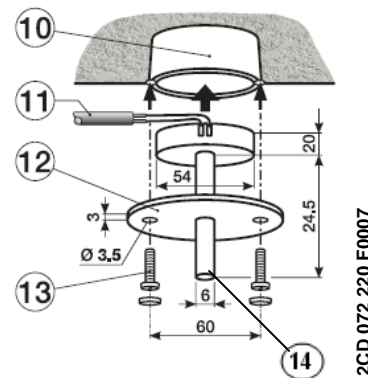

LF/U 2.1

- | | |
|------------------------------------------------|--------------------------------|
| 1 Label carrier | 8 Light sensor inputs LF/U 2.1 |
| 2 Programming button | 9 Light sensor LF/U 2.1 |
| 3 Programming LED | 10 FM switch box |
| 4 Bus terminal connection | 11 Shielded sensor cable |
| 5 Switch position display and manual operation | 12 Cover |
| 6 Load circuits | 13 Fixing screw |
| 7 Control circuits | 14 Light sensor rod |

Note

When positioning the Light Sensor in the room it is important to ensure that the individual control circuits do not interfere with one another. The Light Sensor should be mounted above the area in which the actual lighting intensity is to be measured.

The luminaries or sunlight may not shine directly into the brightness sensor. Pay attention to unfavourable reflections for example from mirrored or glass surfaces.

The white fibre-optic rod can limit the detection range and reduce the lateral lighting sensitivity to external lighting sources.

If the Light Sensor is not connected to the Light Controller LR/S, a DC voltage of a few mV can be measured directly with a multi-function measurement device. The measured value is between 0 mV (absolute darkness) and a few 100 mV depending on the brightness. If 0 V is also measured at normal brightness, this is due to an open circuit, short circuit or inverse polarity fault or a defective sensor.

2.2.3 Dimension drawing

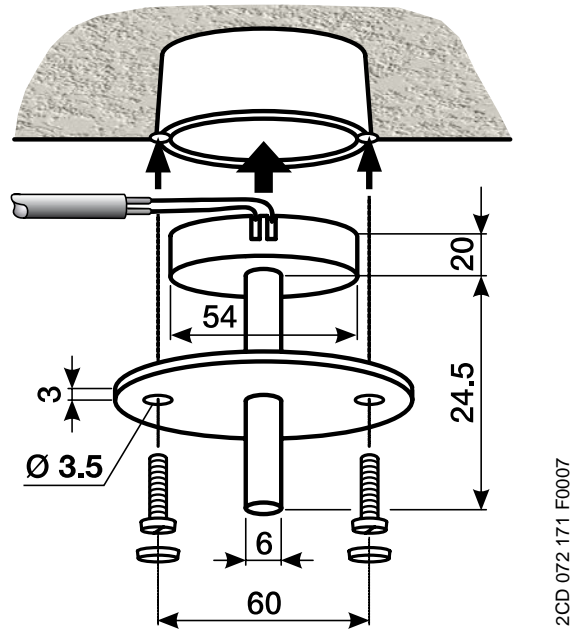

LF/U 2.1

Dimensions

Flush mounted device	For installation in 60 mm flush mounted box
Dimensions	54 x 20 (Ø x H)

2.2.4 Polar diagram

The Light Sensors include two light rods. The white fibre-optic rod has a smaller detection range and is less sensitive to lateral lighting influences. This rod can be used if the detection range has to be limited as the reflected light may be influenced, for example, by window sills, which affects the large reference area of the clear fibre-optic rod.

Note

Please note that the white rod may not be subject to direct sunlight, artificial light or reflections. This leads to a direct misinterpretation of the brightness in the reference area and thus to incorrect constant lighting control.

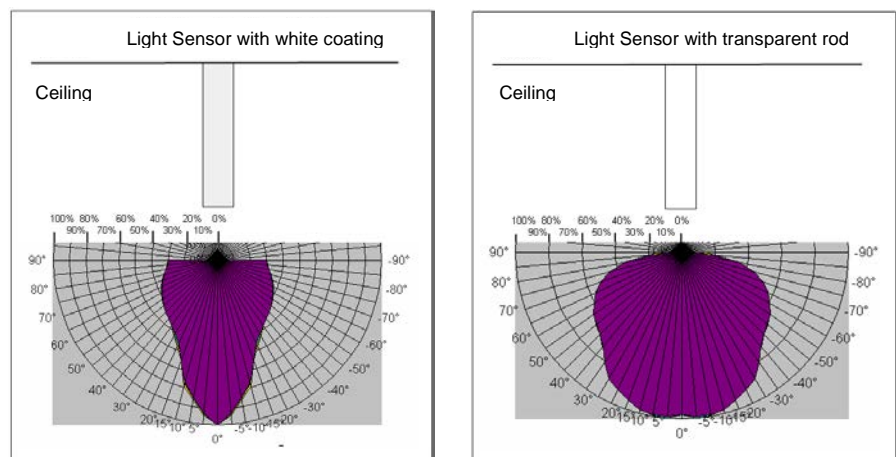

The diagrams show the light sensitivity of the sensors in the room. The percentage values refer to the maximum sensitivity of the Light Sensor.

2.3 Assembly and installation

The ABB i-bus Light Controllers LR/S x.16.1 are suitable for installation in the distribution board or small enclosures for fast installation on 35 mm mounting rails to DIN EN 60 715.

The mounting position of the Light Controller can be selected as required and no auxiliary voltage is required. The device is supplied with power via the KNX.



Danger

Accessibility to the device for the purpose of operation, testing, visual inspection, maintenance and repair must be provided (DIN VDE 0100-520).

The voltage supply to the device must be switched off before mounting work is performed.

The installation and commissioning may only be carried out by electrical specialists. The appropriate norms, guidelines, regulations and specifications should be observed when planning and setting up electrical installations.

The electrical connection is implemented using screw terminals. The connection to the KNX is established using a bus connection terminal. The terminal designation is located on the housing.

The devices should be protected from damp, dirt and damage during transport, storage and operation.

Important

The device should only be operated in a closed housing, e.g. distribution board.

The devices should not be operated outside the specified technical data range.

The Light Sensor LF/U 2.1 is optimised for ceiling installation in a commercially available 60 mm flush mounted box. The brightness detection can be influenced with the enclosed fibre-optic rods. The detection range should be taken from the [polar diagram](#).

The luminaries may not shine directly onto the brightness sensor. Pay attention to unfavourable reflections, e.g. from mirrored or glass surfaces.

2.4 Description of the inputs and outputs

The switching outputs of the Light Controller are potentially isolated (floating).

Different phases of the 230 V operating voltage can be connected to neighbouring outputs.

Control and load ends are electrically isolated from the KNX.

When connecting the control line it is important to consider that the control outputs each feature a common reference ground with one another.

The sensor inputs are electrically isolated from the KNX. When connecting the control line it is important to consider that the control outputs each feature a common reference ground with one another.

Caution

The connection of a 230 V mains voltage supply to one of the 1-10 V outputs or sensor inputs will cause the destruction of the 1-10 V end stage or the corresponding sensor input.

2.5 Special operation states

The behaviour with bus voltage failure and recovery can be parameterised. The exact response after a download and bus reset is described in detail in chapter [Planning and application](#).

An open 1-10 V control line switches on the maximum ballast brightness.

A short circuited control line generates the minimum dimming value.

The minimum dimming value is also set if the control cable polarity is reversed. In all three cases – open circuit, short circuit and incorrect polarity – dimming of the lighting is not possible.

An open Light Sensor cable which results in maximum cable resistance means the same as a dark room for the Light Controller. The 1-10 V output is controlled with maximum brightness during light control.

The same behaviour is also exhibited with a short circuit and if the sensor cable polarity is reversed. The sensor value can be read via the object *Sensor value*, No. 32, 57, 82 or 107 of the corresponding output. This value corresponds with the physically measured value on the sensor input and not the Lux value in the room. In all three fault scenarios – open circuit, short circuit and incorrect polarity – the value read via the object *Sensor value* is equal to 0.

This value corresponds with the value of absolute darkness.

2.6 Assignment of the physical address of a KNX device

The assignment of the address of the ABB i-bus[®] Light Controller is carried out via the ETS and the programming button on the device.

The device features a programming button located on the edge of the device for assignment of the physical device address. The red programming LED lights up after the button has been pushed. It switches off as soon as the ETS has assigned the physical address or the programming button is pressed again.

2.7 Checking Light Sensor LF/U 2.1

On the Light Controller a DC voltage of a few mV can be measured directly with a multi-function measurement device. Disconnect the sensor from the LR/S for this purpose. The value is between 0 mV (absolute darkness) and a few 100 mV depending on the brightness. If 0 mV is also measured at normal brightness, this is due to an open circuit, short circuit or a defective sensor.

2.8 Manual operation

The Light Controller has a manual operating feature. The switch contact can be switched ON or OFF and thus the supply voltage to the electronic ballast using an operating element on the relay. The operating element simultaneously indicates the switch status.

Note
<p>The Light Controller does not feature electrical monitoring of the manual actuation and cannot therefore react to manual operation.</p> <p>From a power engineering point of view the relay is only actuated with a switching pulse if the known relay position has changed. This means that after manual operation, a repeated switching command on the bus will not cause a contact change. The Light Controller assumes that no contact changeover has occurred and that the correct contact position is set.</p> <p>An exception to this situation is after bus voltage failure and recovery. In both cases, the relay position is recalculated in dependence on the parameterisation and always set depending on the contact setting.</p>

2.9 Supplied state

The Light Controllers are delivered with the physical address 15.15.255. The load connection terminals and the relay are open and the bus terminal is fitted.

Please note that vibration during transport can change the relay settings. The contact position can be recognised at any time on the device by a visual inspection and can be changed if necessary by a manual operation.

The application program *Control Dim xf 1-10V/1* (x = 2 or 4, number of outputs) is preloaded.

2.10 Maintenance and cleaning

The Light Controller and Light Sensor are maintenance free. No repairs should be carried out by unauthorised personnel if damage occurs, e.g. during transport and/or storage.

The warranty expires if the device is opened.

If devices become dirty, e.g. the cover of the Light Sensor, it can be cleaned using a dry cloth. Should a dry cloth not remove the dirt, the devices can be cleaned using a slightly damp cloth and soap solution. Corrosive materials or solvents should never be used.

In order to avoid negative influence on the brightness detection it is necessary to be very careful when cleaning the rods of the Light Sensor.

3 Commissioning

3.1 Overview

The Light Controller LR/S x.16.1 and the Light Sensor LF/U 2.1 do not require an additional power supply. The connection to the KNX is sufficient to enable the Light Controller and Light Sensor functions.

You will require a PC or Laptop for parameterisation with the ETS (from ETS2 V1.3) and a connection to the ABB i-bus®, e.g. via an RS232 or USB interface. If ETS3 is used a *.VD3 or higher type file must be imported.

The application program *Control Dim xf 1-10V/1* (x = 2 or 4 outputs) provides the device with a comprehensive and flexible range of functions. The standard settings allow simple commissioning. The functions can be extended if required.

Each individual output of both Light Controllers features the same technical characteristics and software functions. It is thus possible, depending on the application, to freely define every output and to parameterise them accordingly.

The Light Sensor LF/U 2.1 can be assigned to any output.

If required even two or more Light Sensors can be assigned to an output (control circuit). In this manner an acceptable constant lighting control is established in a room even with difficult lighting conditions. A calibration (setting) of the control circuits with one or more Light Sensors should be undertaken in the operating range (target brightness). During this calibration the final conditions which are prevalent in the room must exist as these reflection and absorption properties directly affect the control circuit algorithm. The description of the calibration procedure as well as correct positioning of the Light Sensor can be found in chapter [Constant lighting control](#).

The following table provides an overview of the functions that are possible with the Light Controller LR/S x.16.1, the Light Sensor LF/U 2.1 and the application program *Control Dim xf 1-10V/1*" (x = 2 and 4 outputs):

Properties/Parameterisation possibilities	LR/S 2.16.1	LR/S 4.16.1
Installation type	MDRC	MDRC
Number of outputs	2	4
Light Sensor LF/U 2.1 inputs	2	4
Module width (space unit)	4	6
Manual operation	■	■
Contact position display	■	■
I _n rated current	16 A	16 A
1-10 V control line	100 mA	100 mA
Length 1-10 V control line per output	100 m	100 m
Length of shielded Light Sensor cable per Light Sensor LF/U 2.1	100 m	100 m

Continued Properties/Parameterisation possibilities	LR/S 2.16.1	LR/S 4.16.1
Switch function		
Brightness value when turned on	■	■
Dimming speed for switch on and off	■	■
Dimming		
Dimming speed can be changed via KNX	■	■
Minimum and maximum dimming values	■	■
Switch on/off via rel. dimming	■	■
Brightness value	■	■
Dimming speed for transition brightness values	■	■
Minimum and maximum brightness values	■	■
Set switch on and off via value	■	■
Brightness control	■	■
Control speed	■	■
Dimming value for lighting control	■	■
Lighting control can be switched off via the switch, dim brightness command	■	■
Lighting control can be switched on via the switch command	■	■
Optional use of several Light Sensors per control circuit	■	■
Fluorescent strips can be controlled in different ways with characteristic adjustment	■	■
Control circuit calibration via daylight and artificial lighting calibration	■	■
Automatic recording of lighting characteristic for the determination of optical control parameters	■	■
Target value can be changed via the bus	■	■
Slave mode in lighting control	■	■
Response with switch/dim/brightness/preset and scene command can be parameterised	■	■
Brightness weighting between master and slave via characteristic adjustment	■	■
Internal or external communication object master/slave connection	■	■
Reaction on bus voltage recovery	■	■
Presets (4 items)	■	■
Scenes (8 bit scene)	■	■
Assignment of the output in up to 18 scenes	■	■
Forced operation		
2 bit coded forced operation	■	■
1 bit forced operation recall	■	■
Behaviour after bus voltage recovery	■	■
Blocking , block output via 1 bit object	■	■

Continued Properties/Parameterisation possibilities	LR/S 2.16.1	LR/S 4.16.1
Special functions		
4 point characteristic adjustment	■	■
Reaction on bus voltage failure and recovery	■	■
Resolution of the status response (feedback)	■	■
Additional functions		
- Slave mode e.g. for integration in the constant lighting control	■	■
- Staircase lighting	■	■
Prewarning via dimming and/or KNX object	■	■
Staircase lighting time via the bus	■	■
Legend: ■ = property applies		

3.2 Parameters

This chapter describes the parameters of the Light Controller using the parameter window. The parameter window features a dynamic structure so that further parameters or whole parameter windows may be enabled depending on the parameterisation and the function of the outputs.

In the following description *Output X* represents all outputs of the Light Controller. It is possible to program commonly for all outputs or for each one individually.

Note
Ensure when changing between individual and common parameterisation of the parameters that the parameterisation settings and group addresses for the objects already implemented are not accepted.

The individual parameter window and the parameter window for all outputs only differ in the designation of their outputs.

For this reason only parameter windows for common programming X... are described. Here X is used to represent A-B for a 2-fold lighting control and A-D for a 4-fold lighting control.

The parameter windows for outputs A, B, C or D are identical.

The default values of the parameters are underlined, e.g.

Option: yes
 no.

Indented parameter descriptions indicate that this parameter is only visible when the main parameter is parameterised accordingly.

The illustrations of the parameter windows in this manual correspond to the ETS3 parameter windows. The user program is optimised for ETS3. Using the corresponding *.VD2 file it is also possible to parameterise and engineer the Light Controller without problems using ETS2. In the ETS2 it is possible however, that the parameter window is automatically split by the ETS user interface if all parameters are used.

If in the following the object *Switch* or *Brightness value* is mentioned, they also apply for the objects *Switch/Status* or *Brightness value/Status*.

3.2.1 Parameter window *General*

In this parameter window all main parameter settings are undertaken.

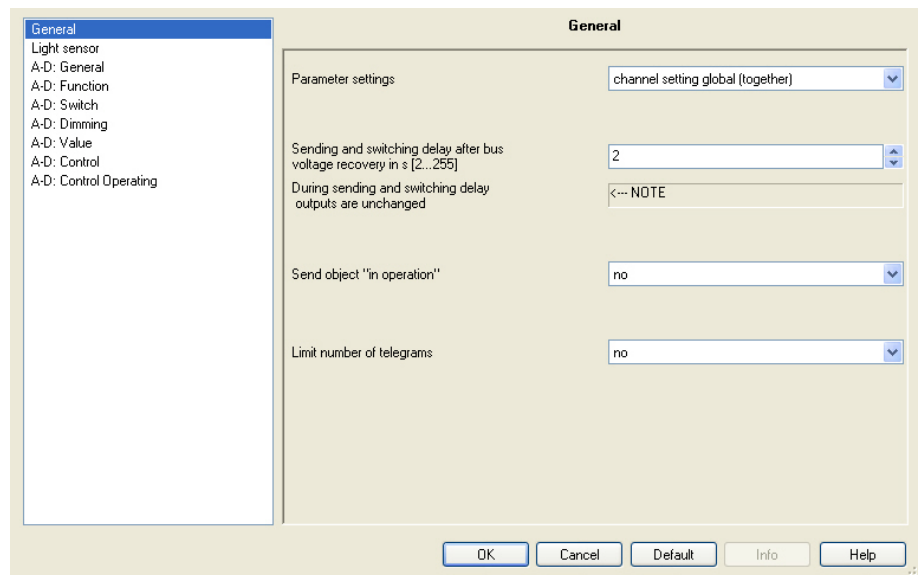

Parameter settings

Options: channel setting global (together)
channel setting individual

For every output an individual setting can be undertaken separately for every output. Particularly in large KNX systems, it is frequently the case that all outputs must be assigned with the same parameters. For this all settings only need to be made once in the device. These settings apply for all outputs.

- *channel setting global (together)*: The parameter window A-X: appears (with the 2-fold LR/S X = B and with the 4-fold LR/S X = D), which applies for all outputs in the same manner.
- *channel setting individual*: All parameter windows for every individual output appear.

Note

With a change from individual to common programming of the parameters, the settings and object allocations already implemented are not accepted.

Sending and switching delay after bus voltage recovery in s [2...255]

Options: 2...255 s

Only telegrams are received during the send and switching delay. However, the telegrams are not processed. The outputs remain unchanged. No telegrams are sent on the bus.

After the sending and switching delay, telegrams are sent and the states of the outputs are set to correspond to the parameterisation or the communication object values.

If communication objects are read during the sending and switching delay (e.g. by a visualisation system), these read requests are stored and a response is sent after the send and switching delay has been completed.

An initialisation time of about two seconds is included in the delay time. The initialisation time is the time that the processor requires to be ready to function.

Note
<p>The first switching action will only be initiated when enough energy is available to switch all contacts safely to the parameterised switching state with a bus failure. This can mean that the initial switching action will occur at a later time than intended by the parameterised switching delay. The send delay is not influenced by this measure.</p> <p>The maximum switching operations per minute of the relay should be taken from the Technical data.</p>

Send object “in operation”

Options: no
 send value 0 cyclically
 send value 1 cyclically

The *in operation* communication object indicates the correct function of the device on the bus. This cyclic telegram can be monitored by an external device. If a telegram is not received, the device may be defective or the bus cable to the transmitting device may be interrupted.

- *no*: The communication object *In operation* is not enabled.
- *send value 0 cyclically*: A telegram with the value 0 is sent cyclically by the Light Controller on the KNX via the *in operation* telegram communication object.
- *send value 1 cyclically*: A telegram with the value 1 is sent cyclically by the Light Controller on the KNX via the *in operation* telegram communication object.

If cyclic sending of a telegram is selected and additional parameter appears:

Sending cycle time in s [1...65.535]

Options: 1...60...65.535

The sending cycle time determines the time interval after which a telegram parameterised with the value 1 or 0 beforehand is sent cyclically.

Limit number of telegrams

Options: no
 yes

In order to limit the bus load caused by the device, it is possible to parameterise a limit on the number of telegrams.

- *yes*: The following parameters appear:

Max. number of sent telegramsOptions: 1...20...255**in Period**Options: 50 ms/100 ms...10 s...30 s/1 min

This parameter sets the number of telegrams which can be sent by the device within a period.

Note

It counts the number of telegrams sent within a parameterised period. As soon as the maximum number of sent telegrams is reached, no further telegrams are sent on the bus until the end of the period. A new period commences at the end of the previous period. The telegram counter is reset to zero and sending of telegrams is allowed again. The current object value is always sent at the time of transmission.

3.2.2 Parameter window *Light sensor*

In the parameter window *Light sensor* the Light Sensors LF/U 2.1 connected to the Light Controller are assigned to the outputs.

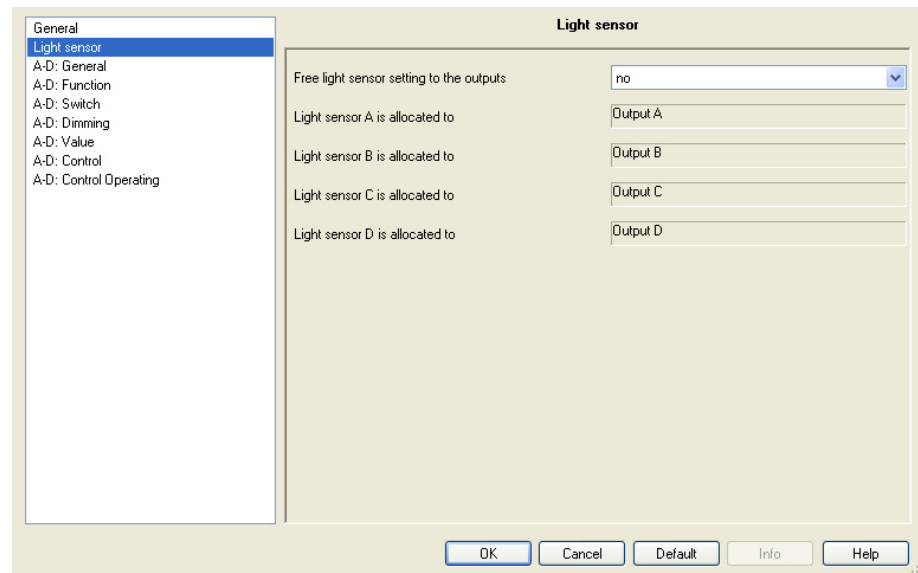

If several Light Sensors are assigned to an output, it is necessary to define which sensor value is used as the actual value (input variable) for the control circuit.

For further information see: [Parameter window X: Control](#) and [Constant lighting control](#)

Free light sensor setting to the outputs

Options: no
yes

A free light sensor setting to the outputs can be parameterised with these parameters.

- *no*: On the 2-fold LR/S, Light Sensor A is allocated to output A and Light Sensor B is allocated to output B. On the 4-fold LR/S the additional Light Sensor C is allocated to output C and Light Sensor D is allocated to output D.
- *yes*: The parameter window changes:

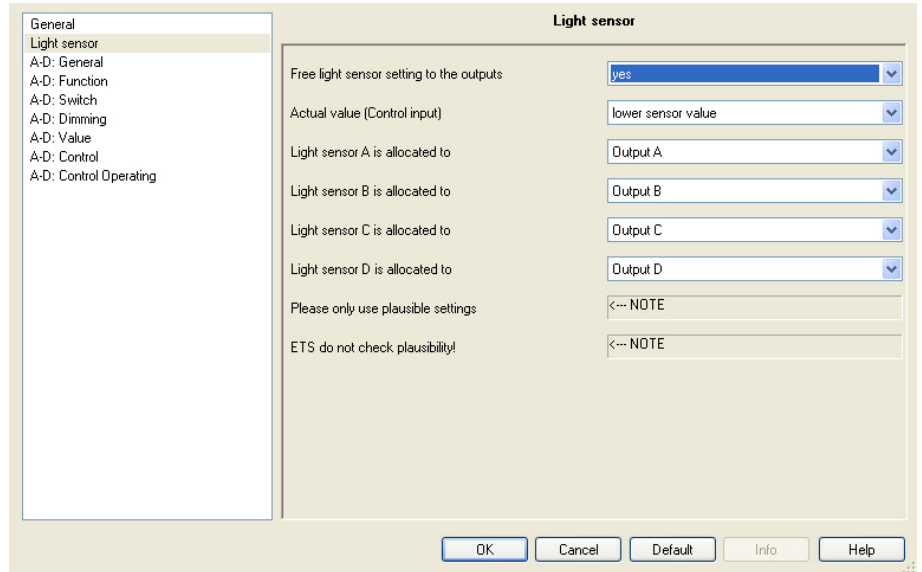

Actual value (Control input)

Options: lower sensor value
 average sensor value
 upper sensor value

If the output is assigned with several Light Sensors, the actual value for the constant lighting control is determined with this parameter. The lowest, the largest or the average value of the detected sensor values can be used for lighting control. If only a single Light Sensor is assigned to an output, the current sensor value is used as the actual value irrespective of the setting.

- *lower sensor value*: The Light Controller uses the lowest sensor value of the assigned Light Sensors as its actual value for constant lighting control. All Light Sensors are considered which are assigned to the output (control circuit). With this setting the room is lit up most brightly by constant lighting control. The setpoint should not be undershot in normal, malfunction free operation, e.g. no reflections or no direct incidence of light on the Light Sensor.
- *average sensor value*: The Light Controller uses the linear average value of the assigned Light Sensors as its actual value for constant lighting control.
- *upper sensor value*: The Light Controller uses the highest sensor value of the assigned Light Sensors as its actual value for constant lighting control. This setting ensures that constant lighting control requires the least possible level of artificial lighting. This achieves the largest possible conservation of energy. However, the brightness at many locations in the room is very likely below the target brightness level.

Light sensor x is allocated to

(x = A or B with 2-fold LR/S or A, B, C and D with 4-fold LR/S)

Options: Output A
 Output B
 Output C (4-fold Light Controller)
 Output D (4-fold Light Controller)
 No Output

With this parameter every Light Sensor can be allocated to any output.

If several Light Sensors are assigned to an output, the calculated sensor value is used as the actual value (input variable) for the constant lighting control. The actual value is calculated in accordance with condition defined in the *Actual value (Control input)*.

For further information see: [Parameter window X: Control](#)

The programmer is responsible to ensure that a useful assignment of the Light Sensor is undertaken.

The ETS3 does not undertake a plausibility test.

Note

For ideal constant lighting control every controllable lighting group (Light Controller output) is assigned to exactly one sensor. This sensor should be positioned in the room so that it is not influenced by any other source of artificial lighting. Furthermore, no direct incidence of light and no reflections may influence the Light Sensor.

For further information see: [Placing of the Light Sensor](#).

3.2.3 Parameter window X: General

In this parameter window general settings for the Light Controller are undertaken.

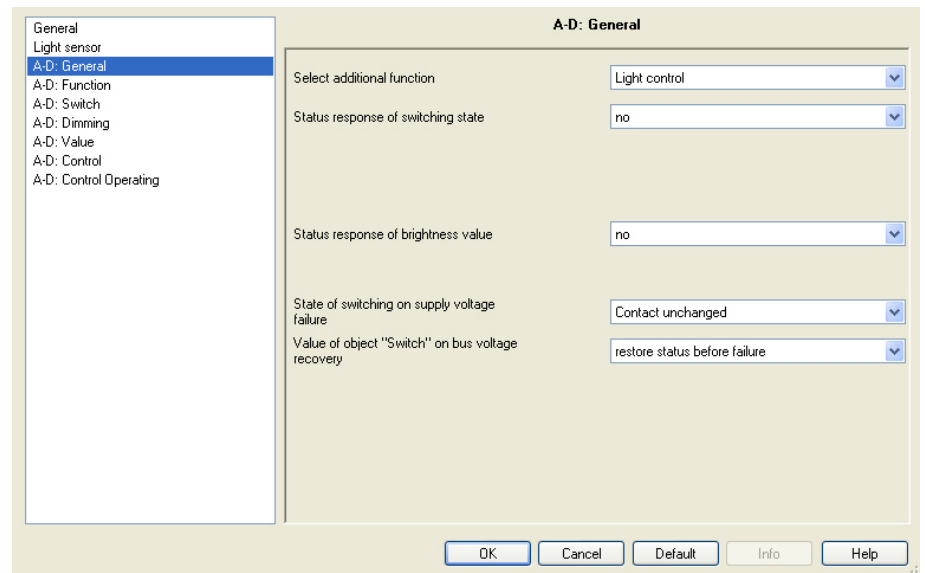

Select additional function

Options: none (Switch/Dim actuator)
Light control
 Slave mode in lighting control
 Staircase light

This parameter defines the additional functions of the LR/S output.

- *none (Switch/Dim actuator)*: The output operates purely as a 1-10 V Switch/Dim actuator.
- *Light control*: The output undertakes lighting control. Depending on the brightness detected via the Light Sensor, the 1-10 V outputs are controlled so that the luminance measured by the Light Sensor (brightness of surfaces underneath the Light Sensor) is kept constant. The setpoint value should be set via a commissioning routine with artificial and daylight calibration. Refer for this purpose to the parameter window [X: Control](#) and [X: Control Operating](#) as well as the chapter [Constant lighting control](#). The lighting control can be switched on and off via the *activate control* communication object. Accordingly, an energy efficient building automation with optimum brightness during occupancy can be generated together with the use of a Presence Detector. The parameter windows [X: Control](#) and [X: Control Operating](#) are enabled. In these parameter windows the properties of the [Constant lighting control](#) are parameterised.
- *Slave mode in lighting control*: The output of the light controller is defined as a slave. This slave output must then be forcibly operated by a master.

The parameter window [X: Slave](#) is enabled. In this window the properties of the slave output are parameterised, e.g. it can be parameterised if the slave output in the Light Controller is directly (internal) or externally controlled via a communications object. Hereby other ABB i-bus® devices, e.g. DALI gateways or dimmers can be integrated as slaves into the constant lighting control. The required brightness value is provided by the master in the Light Controller via the communication object *Brightness value of slave*. The brightness in slave mode can be limited by brightness values. Parameterisation is undertaken in the parameter window [X: Value](#).

- *Staircase light*: The lighting is switched off or dimmed down slowly automatically after a predetermined time. The basis brightness is the brightness to which the output is set after the staircase lighting time has timed out. This basis lighting time can also be not equal to zero.

Example

This function can ensure, e.g. that a basis brightness level always exists in the hallways in senior citizen homes or hospitals. Only after someone has entered the hallway (detected by a presence detector) will maximum brightness switch on. It is dimmed down automatically to the basis brightness after the staircase lighting time has timed out and when nobody is in the hallway.

Setting of a prewarning before the staircase lighting is switched off is possible via dimming and/or by a 1 bit object. With a 1 bit object any desired optical indication or an acoustic signal can be implemented as a prewarning feature.

With the option *Staircase light* no light control is possible with this output. The output operates as a normal 1-10 V Switch/Dim actuator or a staircase lighting timer.

The special properties of the staircase lighting function are defined in the [X: Staircase Lighting](#) parameter window.

For the staircase lighting function the parameterised dimming limit values defined in the parameter window [X: Dimming](#) apply.

Note

These three additional functions, *Control*, *Staircase Lighting* and *Slave mode*, can assume three operating states:

Additional function is not active: The additional function has been deactivated via its object *Select additional function* (telegram received with value 0). In this state the Light Controller acts like a normal Switch/Dim actuator. ON commands do not cause the function to start. Only after a telegram with the value 1 has been received on the object *Activate additional function* is it possible to start the additional function.

Additional function is in standby mode: The additional function is active but has however been ended, e.g. by the OFF command. The additional function still remains active in the background and starts again after an ON command. The *Control* controls, the *Staircase light* runs and the *Slave mode* executes the telegram of the master.

Additional function runs: The *Control* controls, the *Staircase light* runs and the *Slave mode* receives brightness values from the master. With corresponding parameterisation of the switching commands the additional functions can be set to standby mode.

Status response of switching state

Options: no
 yes: via object "Switch/Status"
 yes: via separate object "Status switch"

- *no*: The switch state is not actively sent on the bus.
- *yes: via object "Switch/Status"*: The common object *Switch/Status* receives the switch command and the current status becomes active and is sent on the bus.
- *yes: via separate object "Status switch"*: An additional *Status Switch* object is enabled. Using it a 1 bit telegram with the actual switch status is sent on the bus.

Note

With a change of the parameterisation or after a subsequent switching of the status object, the assignment of the groups addresses already allocated to the *Switch* object are lost and need to be reprogrammed. If the object *Switch/Status* is used for switching and feedback, particular care must be taken with the read and write properties (flags) of the objects.

Unwanted switching actions can be triggered by the responses in a group for other group participants. In a group with several *Switch/Status* objects only one object should feedback the status in order to avoid mutual interference of the participants due to feedback.

With the option *yes*:... two further parameters appear:

Send

Options: only after changing
 if value change and triggered by switch command

Here you set if the response is sent with *only after changing* of the object value or also with every value assignment of the object *Switch* (option *if value change and triggered by switch command*), even if the state does not change.

inverted

Options: no: 0 = OFF, 1 = ON
 yes: 1 = OFF, 0 = ON

This parameter is enabled if the option *yes*:... has been selected beforehand via the separate object *Status switch*.

With this parameter the response of the switching state can be inverted.

With an inverted response the object *Status switch* features the following values:

- 0 = lighting (output) is on
- 1 = lighting (output) is off

Status response of brightness value

Options: no
 yes: via object "Brightness value/Status"
 yes: via separate obj. "Status brightness value"

The parameter defines how the current status of the brightness value of an output (lighting) is sent on the bus.

- *no*: The brightness value is not actively sent on the bus.
- *yes: via object "Brightness value/Status"* The brightness value is sent on the bus via the object *Brightness value/Status*.
- *yes: via separate object "Status brightness value"* An additional *Status brightness value* object for the feedback is enabled.

Note

The changed, updated brightness value is sent only at the end of the dimming process, i.e. when the end value is reached after switching, scene or preset recall. This can mean that during the dimming process the current brightness value is not displayed.

With a change of the parameterisation or after a subsequent switching of the status object, the assignment of the groups addresses already allocated to the *Brightness value* object are lost and need to be reprogrammed.

With the options *yes*:... two further parameters appear:

Send

Options: only after changing
 if value change and triggered by brightness com.

- *only after changing*: The brightness status is only sent when a change occurs.
- *if value change and triggered by brightness com.* With every value change and via the object *Brightness value* the brightness status is sent even when the brightness does not change. Telegrams to the switch or dim objects, scenes or preset recalls as well as the activation of the staircase lighting function does not initiate sending of the brightness status, if the brightness does not change as a result.

**Disable time after sending object
"Status brightness value" in s [0..10]**

or

**Disable time after sending object
"Brightness value" in s [0..10]**

Options: 0...10

With this parameter sending of the *Status brightness value* can be limited. As a result the bus load can be reduced significantly.

This defines the time intervals at which the brightness values are sent on the bus. The disable time only relates to the status objects *Status Brightness value* and *Brightness value*.

State of switching on supply voltage failure

Options: Contact open
 Contact closed
 Contact unchanged

With this parameter the relay for the output can be set to a defined state at a bus voltage failure.

The 1-10 V control output assumes a high resistance state with a bus voltage failure.

Thus the lamps are controlled with a brightness value of 100 %. A prerequisite is a closed relay contact of the output.

Note

Constant lighting control is no longer possible if the bus voltage fails.

Value object "Switch" on bus voltage recovery

Options: restore status before failure
 write with 0
 write with 1

With this parameter the load output can be set to a defined state at bus voltage recovery.

- *restore status before failure*: The brightness level before failure of the bus voltage is restored.
If already controlled before bus voltage failure, it is also the case after bus voltage recovery.
- *write with 0*: The object is written with a 0 at bus voltage recovery. The contact position is redefined and set in dependence on the set device parameterisation.
- *write with 1*: The object is written with a 1 at bus voltage recovery. The contact position is redefined and set in dependence on the set device parameterisation.

Example

If for example, the staircase lighting function is activated, the staircase lighting can be triggered by a 1 switch command after bus voltage recovery. If constant lighting control has been parameterised before bus voltage failure it will be reactivated. The output is switched off by writing the value 0 to the object *Switch*. The lighting control switches to standby mode. When writing the switch object with the value 1, control is implemented with the set brightness value

Note

If in a parameter window the slave mode after bus voltage recovery is parameterised as active, and the behaviour of the slave operation at switch on is simultaneously deactivated (also parameter window *X: Slave*) and if the output generates an ON command after bus voltage recovery with the parameters described here, the slave mode is immediately deactivated. i.e. the parameter described here *Value object "Switch" on bus voltage recovery* has a higher priority than the parameter in the parameter window *X: Slave*, "*Slave mode after supply voltage recovery*".

3.2.4 Parameter window X: Function

In this parameter window additional functions of the output can be enabled.

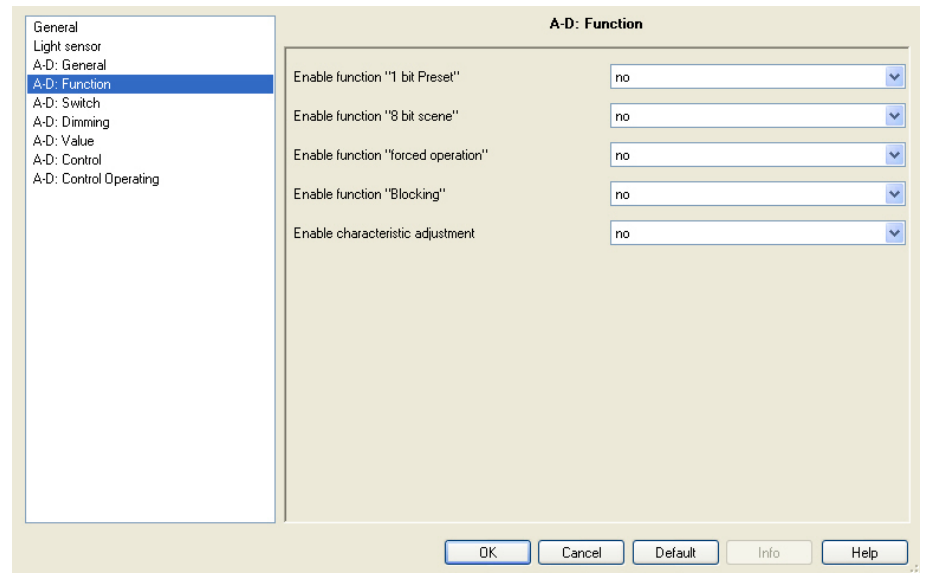

Enable function "1 bit preset"

Options: no
 yes

With this parameter the output can be enabled for a 1 bit preset.

This function is used to recall or save brightness values via a 1 bit object.

- Yes: A further parameter appears:

Restore presets with standard value during download

Options: no
 yes

This parameter defines if the preset values currently in the device are overwritten during download by the set preset values in the ETS.

This function is useful for example if the settings made by the user are to be reset and the lighting is to be set with a defined brightness value.

The special properties of the presets are defined in the [X: Presets](#) parameter window.

Enable function 8 bit scene

Options: no
 yes

With this parameter the output can be enabled for an 8 bit scene.

This function enables the recall or saving of up to 64 scenes via a 1 byte object. Project-specific, manually set brightness values can be saved via the 1 byte object *8 bit scene*. Every output of the Light Controller can be integrated in up to 15 scenes with any standard brightness values and transition times.

- Yes: A further parameter appears:

Restore scene values with standard values

Options: no
 via download
 via object "restore standard scene"
 via download or via object

This parameter defines if the brightness values allocated to the scenes currently in the device are overwritten by the brightness values in the ETS.

This function is useful for example, if the scene settings of the user are to be undone.

The reset of the scene values are possible via an ETS download or via object *restore standard scene*.

The special properties of the 8 bit scene are defined in the [X: Scene \(x\)](#) parameter window. Every output of the Light Controller can be integrated in up to 18 scenes.

Enable function "forced operation"

Options: no
 1 bit control
 2 bit control

With this parameter the output can be enabled for forced operation.

- *1 bit control*: A 1 bit *Forced operation* object is enabled. If the Light Controller receives a telegram with the value 1 via this object, the output of the Light Controller is forcibly operated. With the value 0 the forced operation is rescinded and the output is once again released. Both the following parameters are enabled with parameterised 1 bit control :

Brightness while object value = 1 (forced operation = active, ON)

Options: 100 % (255), 99 % (252)...0 % (Off)

The brightness value applied for switching on the lighting of the output during activated forced operation, can be parameterised with this parameter. Forced switch off of the output is also parameterised.

Setting force operation after bus voltage recovery

Options: inactive
switch on by force

Using this parameter the state of forced operation after bus voltage recovery is parameterised.

- *inactive*: The output is enabled after bus voltage recovery and is no longer subject to forced operation. If parameterised constant lighting control was activated before forced operation it will be active.
- *switch on by force*: The output is forced operated and switched with the brightness, which has been parameterised in the brightness parameter if the object value = 1 (*forced switch on*).

How does forced operation function?

The active forced operation; irrespective of if it is a 1 bit or 2 bit recall, has an influence on the overall behaviour of the output. When the forced operation is recalled, the parameterised brightness value in the ETS is set. The currently set brightness value is stored intermediately. A dim command currently operating or lighting control is interrupted and the target brightness value is directly saved.

Brightness values received during forced operation are not set, however they are processed in the background and saved. Commands and lighting control operating in the background are also saved. Relative dim commands and dim ramps are ignored. This also applies for prewarning times at the end of the staircase lighting function. The target brightness value is saved directly.

With the end of forced operation the brightness value stored in the background is set. The output returns to the state it was in before forced operation. If an additional function was active, e.g. constant lighting control, staircase lighting or slave operation, this is also active after forced operation. If the Light Controller had control before forced operation, the lighting control will be reassumed after forced operation with the switch on brightness. If the staircase lighting time has not yet timed out it will continue.

The state of the additional function is displayed during forced operation via the object *Status function*. Even when the respective brightness value is not switched to the output during forced operation.

The actual forced operation is indicated in the second bit of the status byte (object *Status byte*).

Forced operation has a higher priority than blocking an output.

- *2 bit control*: A 2 bit *Forced operation* object is enabled. If the Light Controller receives a telegram with the value 2 or 3 via this object, the output of the Light Controller is forcibly operated.

The reaction to another telegram value is described in the following telegram:

Value	Bit 1	Bit 0	State	Description
0	0	0	Free	If the object <i>Forced operation</i> receives a telegram with the value 0 (binary 00) or 1 (binary 01), the output is enabled and can be actuated via different objects.
1	0	1	Free	
2	1	0	Forced OFF	<p>If the object <i>Forced operation</i> receives a telegram with the value 2 (binary 10), the output of the Light Controller is forced OFF and remains inhibited until forced operation is again deactivated.</p> <p>Actuation via another object is ignored as long as the forced operation is active. Commands are run in the background and the end values are saved.</p> <p>After deactivation of forced operation the brightness value which is continuously processed in the background is set.</p>
3	1	1	Forced ON	<p>If the object <i>Forced operation</i> receives a telegram with the value 3 (binary 11), the output of the Light Controller is forced ON and remains inhibited until forced operation is again deactivated.</p> <p>Actuation via another object is ignored as long as the forced operation is active. Commands are run in the background and the end values are saved.</p> <p>After deactivation of forced operation the brightness value which is continuously processed in the background is set.</p>

Both the following parameters are enabled with parameterised *2 bit control*:

Brightness while object value = 3 (forced operation = active, ON)

Options: 100 % (255)/99 % (252)...2% (5)/1% (3)/0% (Off)

The brightness value used to control the output when it is forced ON is set with this parameter.

Setting force operation after bus voltage recovery

Options: inactive (value 0)
switch off by force (value 2)
switch on by force (value 3)

This parameter determines which value the object *Forced operation* is assigned, with bus voltage recovery.

- *inactive*: The output is enabled after bus voltage recovery and is no longer subject to forced operation. If parameterised constant lighting control was activated before forced operation it will be active.
- *switch off by force (value 2)*: The output of the Light Controller is forced OFF and remains inhibited until forced operation is again deactivated.
- *switch on by force (value 3)*: The output is switched on and controlled with the parameterised brightness for forced operation in the ETS.

Enable function “Blocking”

Options: no
 yes

The object *Block* is enabled with this parameter. The function of the output can be blocked here via this object so that it cannot be changed via the bus.

The current brightness value of the output is frozen. All commands with the exception of forced operation and the reactions to bus voltage failure and recovery are ignored. Incoming telegrams are not stored intermediately or processed in the background. The information is lost.

An activation of the blocked operation during dimming up and dimming down of the still active staircase lighting and switch or scene function is initially not carried out. Only at the end of the dim process is the output blocked and the brightness frozen. A block during the staircase lighting or control function on the other hand leads to an immediate blocking of the output and freezing of the brightness value. After unblocking, the staircase lighting function continues with dimming (prewarning).

If lighting control or slave operation were active before the block they will be re-established.

Forced operation has a higher priority than the block. With activated forced operation the block function can be activated or deactivated.

In this way the current blocked state is available after forced operation as would be the case without activated forced operation.

Enable characteristic adjustment

Options: no
 yes

- Yes: The parameter window *Characteristic adjustment* is enabled. In this the dim characteristic (lighting dependent on the brightness value) can be changed.

The special properties of the characteristic adjustment are defined in the [X: Charact. Adj.](#) parameter window.

With the characteristic adjustment the curve of the ballasts can be changed to suit requirements. Furthermore, using constant lighting control the brightness value of a second lighting strip (slave) can be increased or reduced in dependence on a master output (lighting strip). In this case the brighter lighting strip should be selected as the master, i.e. the slave output is controlled as darker by the characteristic adjustment.

For further information see: [Characteristic Adjustment](#)

Note

The characteristic adjustment acts directly on the 1-10 V output and not on the objects *Master: Slave brightness value* or *Status brightness value*. This means that a characteristic adjustment must be set in the output of the Light Controller or in the external slave.

In a master/slave combination of LR/S x.16.1 and DG/S 1.1 or DG/S 8.1, a characteristic adjustment may not be transferred to the DG/S.

3.2.5 Parameter window X: Switch

In this parameter window you set how the device reacts on a switch command via the communication object *Switch* or *Switch/Status*.

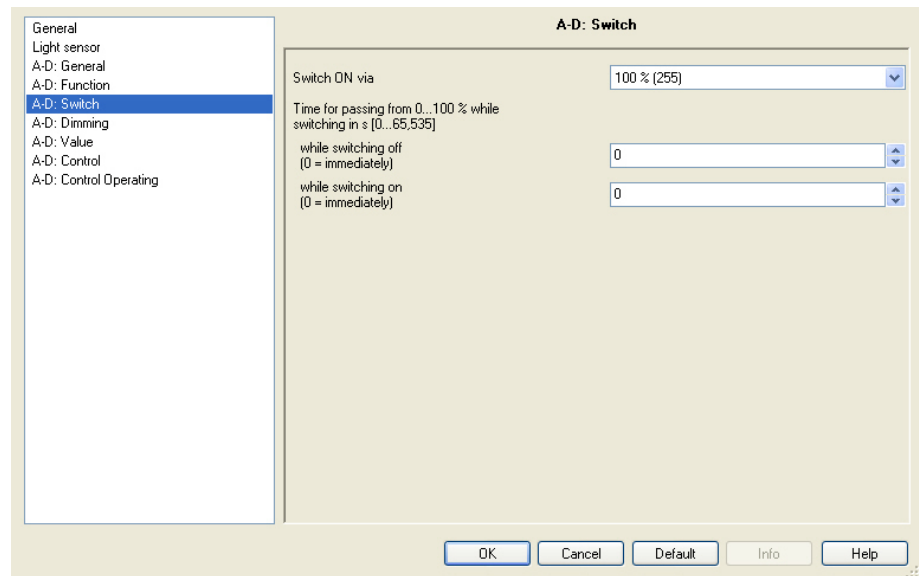

Switch ON via

Options: 100 % (255)
 last brightness value
 99 % (252)
 ...
 2 % (5)
 1% (3)

This parameter determines the brightness of the lighting which is controlled when a *Switch* or *Switch/Status* object receives the telegram value 1.

- *last brightness value*: The brightness value before the last switch off is restored. This is at the least, the brightness value of the lower dimming value, see parameter window [X: Dimming](#).

The last brightness value is the last constant brightness value. This can result from the setting of a brightness value using a switch or dim command and through a scene, preset or staircase lighting function.

Note
<p>At bus voltage recovery the last brightness value is lost. Until a new last value is recognised, the output of the Light Controller switches on with the maximum brightness value, whereby the dimming value is taken into consideration.</p> <p>If the slave mode is in standby mode and the Light Controller receives a telegram with the value 1 on the object <i>Switch</i> or <i>Switch/Status</i>, the last brightness value is not set. The slave mode is activated directly and the brightness value from the object <i>Slave brightness value</i> is set.</p> <p>If switch on with the last brightness value is parameterised and the output is switched on, the brightness value remains unchanged if a new ON command is received. This is because the current brightness value is seen as the last constant brightness value by the Light Controller.</p>

Time for passing from 0...100 % while switching in s [0...65,535]

**while switching off
(0 = immediately)**

Options: 0...65,535

**while switching on
(0 = immediately)**

Options: 0...65,535

This parameter defines how fast the lighting switches on or off with a switching command. The set dimming time relates to the full dimming range of 0 % to 100 %.

Note
<p>The reaction of the Light Controller with activated light control is parameterised in the parameter X: Control and X: Control Operating.</p>

3.2.6 Parameter window X: Dimming

In this parameter window the parameters for dimming of the lighting are set. With the object *Relative dimming* the lighting is dimmed brighter or darker, see [Communication objects](#).

Dimming speed 0...100 % in s [0...65,535]

Options: 0...6...65,535

A dimming ramp is defined by the dimming speed. The dimming ramp is the parameterised time, during this time the Light Controller achieves the value between 0 % and 100 %.

Note

The dimming speed refers to a full, unlimited dimming range, i.e. at a minimum > 0 % or maximum < 100 % dimming value, the dimmer quickly reaches the maximum dimming value.

Maximum dimming value

Options: 100/99...51/50 %

With this parameter the largest brightness value is set which can be controlled with the Light Controller via relative dimming. In this way, the service life of fluorescent lighting can be extended or energy can be conserved.

If the brightness value is above the upper dimming value, e.g. by recall of a preset or a scene, it is only possible to reduce the brightness.

The dimming values do not just apply for dimming but also for the switching and staircase lighting function. During slave operation, when setting a brightness value and when recalling a scene or preset, the value limits which are parameterised in the parameter window [X: Value](#) apply.

The dimming value is independent of the value or control limit.

Note

The reaction of the Light Controller with activated light control is parameterised in the parameter [X: Control](#) and [X: Control Operating](#).

Minimum dimming value

Options: 50/49...20...1/0.3 %

This parameter defines the minimum brightness value, which can be controlled with the Light Controller via relative dimming.

The dimming values do not just apply for dimming but also for the switching and staircase lighting function. During slave operation, when setting a brightness value and when recalling a scene or preset, the value limits which are parameterised in the parameter window [X: Value](#) apply.

The dimming value is independent of the value or control limit.

If switch ON or OFF is parameterised via dimming, switch off or on is immediate when the brightness value of the minimum dimming value is reached.

Note

The minimum possible limit for the brightness of the luminaries is determined by the lower limit of the ballast. If for example, a ballast with a lower limit of 10 % for control of the luminaries is used, it is not possible to fall below this limit when controlling the luminaries. Even if the lower dimming limit of 0.3 % is parameterised and the respective telegram has been sent via KNX, the control remains at 10 %.

With constant lighting control at shutdown of the luminaries if the setpoint value is exceeded, it may be useful to set a lower control limit, e.g. of 0.3 % even when the ballast itself only allows a minimum control level of 10 % when controlling the luminaries.

If for example, a setpoint of 11 % is set in the steady state and the external brightness increases significantly for a brief period, the setpoint of the light control will reduce further without the control of the luminaries changing.

If the external brightness then falls again significantly, the light control will again increase the setpoint. This avoids unnecessary switch off. If the level of external brightness remains high, the illumination will be switched off with the respective delay.

Allow switching on via relative dimming

Options: no
yes

This parameter determines if switched off lighting can be switched on by a *Brighter* dimming telegram.

- *no*: The output must be switched on before dimming.

Allow switching off via rel. dimming

Options: no
 yes

This parameter determines if switched on lighting can be switched off by a *Darker* dimming telegram.

- *no*: The brightness value stays at the lower dimming limit.

**Dim period changeable via object
(Object: Dimming speed 0...100 %)**

Options: no
 yes

This parameter defines if the dimming speed (0...100 %) can be changed via the KNX. The other dimming speeds, e.g. for *Setting brightness* or *Switch* are not changed.

- *yes*: The object *Dimming speed 0...100 %* appears. Using this object the dimming speed for 0...100 % can be modified via the bus. The 2 byte counter values (0...65,536) correspond to the time in seconds which is required to dim from 0 to 255 (from 0 % to 100 %).

The dimming speed relates to the minimum dimming value. If the dimming values are parameterised, the dimming range is still executed with the same speed. This means, that the execution time from the minimum dimming value to 100 % is shorter than the set dimming speed.

Note

The value is overwritten by a download. With a bus voltage failure the value of the change dimming speed via this object is lost, and at bus voltage recovery the value is overwritten with the original value parameterised in the ETS.

3.2.7 Parameter window

X: Value

In this parameter window it is possible to define a brightness value via the 1 byte object *Brightness value*.

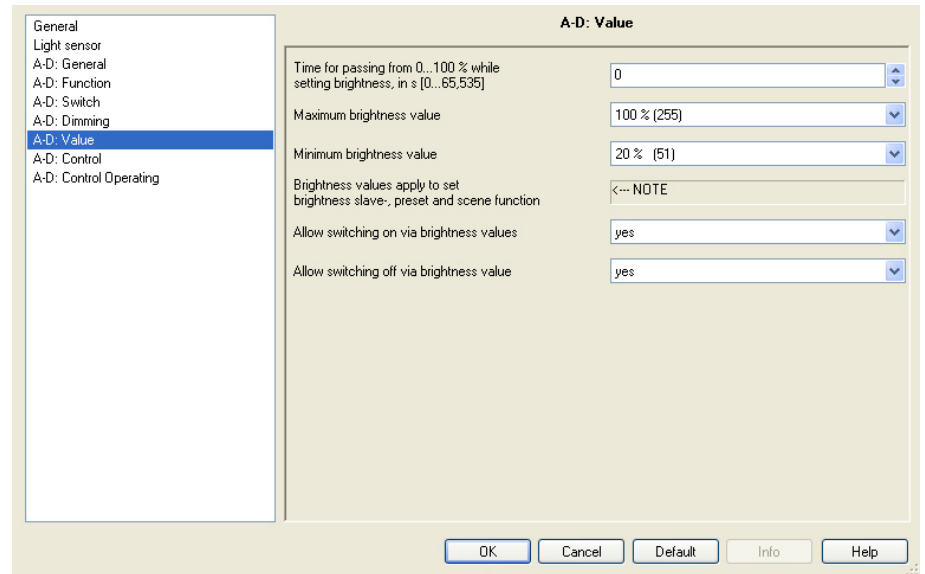

Time for passing from 0...100 % while setting brightness, in s [0...65,535]

Options: 0...65,535

This parameter determines the speed with which the device dims to a new brightness value. The speed is set which is required to dim from 0...100 %.

Maximum brightness value

Options: 100/99...51/50 %

This parameter defines the maximum brightness value, which can control the output via a brightness telegram. The value limit which is used to set a brightness value with the preset and scene function is considered. The limit in slave operation is also active here.

If a brightness value which is greater than the maximum brightness value is received, the output sets the maximum brightness value. This value is reported back on the bus.

The limit value is independent of the:

- Dimming value which is parameterised in the parameter window [X: Dimming](#) and which applies for the dimming, switching and staircase lighting function.
- Control limit which is parameterised in the parameter window [X: Control](#) and which applies during lighting control.

Minimum brightness value

Options: 50/49...20...1/0,3 %

This parameter defines the minimum brightness value, which can control the output via a brightness telegram.

If the Light Controller receives a brightness value less than the minimum brightness value, the minimum brightness value is set.

The smallest minimum brightness value has a value of 0.3 %, thus a switch off is always possible at the parameterised minimum dimming value.

The value limit which is used to set a brightness value with the preset and scene function is considered. The limit in slave operation is also active here.

The control limit is active during the constant lighting control.

If a brightness value is recalled, which is less than the minimum brightness value, the lower brightness value is set.

The limit value is independent of the:

- Dimming value which is parameterised in the parameter window [X: Dimming](#) and which applies for the dimming, switching and staircase lighting function.
- Control limit which is parameterised in the parameter window [X: Control](#) and which applies during lighting control.

Allow switching on via brightness values

Options: no
yes

This parameter determines if switched off lighting can be switched on by a brightness value telegram greater than 0.

Allow switching off via brightness value

Options: no (stop on minimum brightness values)
yes

If a brightness value of 0 is received, you can set here if the lighting is switched off (yes) or if they remain at the minimum value limit.

If a brightness value is received during a dimming process, the dimming process is stopped and then a new brightness value is implemented.

Note

The reaction of the Light Controller with activated light control is parameterised in the parameter [X: Control](#) and [X: Control Operating](#).

3.2.8 Parameter window X: Presets

In this parameter window presets settings can be made.

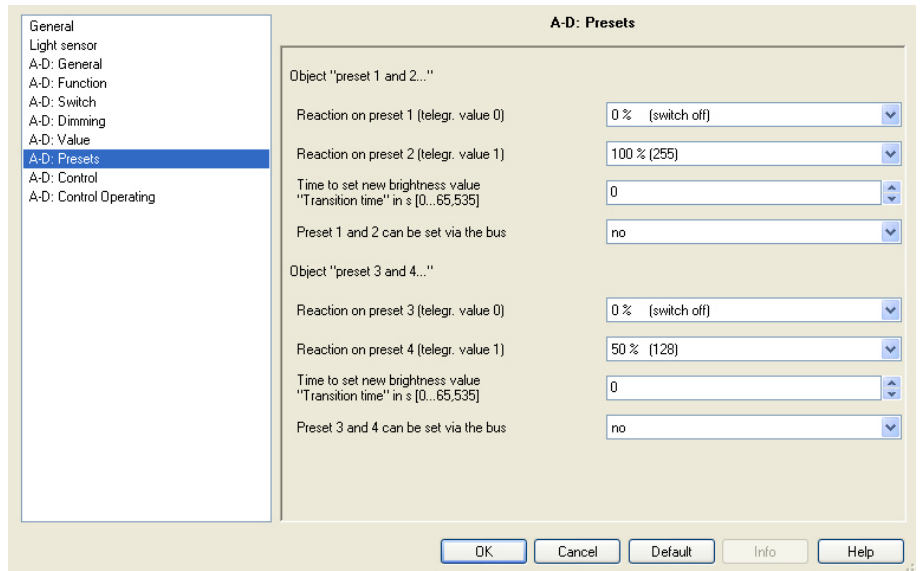

What is a preset?

The presets are used to recall predefined brightness values via 1 bit telegrams.

Four presets are available per output. The presets with an even number (2 and 4) are recalled by a telegram with the value 1, the presets with an odd number (1 and 3) are addressed by a telegram with the value 0. Separate objects are available for recalling and for saving / setting of a preset brightness value.

With the recall of presets; the maximum and minimum values as set in the parameter window [X: Value](#) apply. The values of the value limits are set when the maximum and minimum values are overshoot or undershoot. At a brightness value of 0, a switch off is always executed, independently of the parameter *Allow switching off via brightness value* parameterised in the parameter window [X: Value](#).

A preset recall has no effect on the output with parameterised staircase lighting function.

A preset save command via object *Set preset 1 and 2* is implemented, i.e. at the time as the save command the current brightness value of the output is saved as a new preset value.

The reaction to the preset recall with parameterised slave mode can be parameterised in the [X: Slave](#) parameter window. With the *no reaction* parameterisation a preset recall is ignored with active slave mode. A preset save command is executed. The parameterisation *Slave mode can be deactivated* has the effect that the preset recall is implemented and the slave operation discontinued. If simultaneously the preset command *restore value before first preset call* is parameterised, slave operation is reactivated. Otherwise slave operation is activated by the object *Activate slave mode*.

With the first recall of a preset the current state (brightness value) is stored. At the same time; it does not matter which of the four presets are recalled. Further preset recalls do not initiate a renewed save.

This ensures that the state before the first preset can be re-established. A new preset value is again saved if beforehand the preset has been recalled with the function *restore value before first preset call*.

The reaction to a preset command with active light control can be parameterised in the parameter window [X: Control Operating](#).

The parameterisation undertaken in this parameter window [X: Presets](#) is only transferred to the Light Controller during a download, if in the parameter window [X: Function](#), the preset enable *Restore presets with standard value during download* has been set to yes.

In the following the preset functions are described using the parameters for Preset 1 and 2. The specifications apply for presets 3 and 4.

Reaction on preset 1 (telegr. value 0)

Options: 100/99...1/0 % (switch off)
restore value before first preset call
reset to parameterised value before preset 2

This parameter determines how the output reacts with the recall of preset 1, i.e. meaning that object *Call preset 1 and 2* receives a telegram with the value 0. A fixed brightness value can be recalled.

The following functions can be selected as further selection options:

- *restore value before first preset call*: The state of the output which existed before the preset was first called after a download recall of preset 2, 3 or 4 is restored.

If for example, lighting control via slave operation was active, this is also reactivated and executed. The state is only saved with the first preset recall. Further preset recalls do not initiate a renewed save. Only after a recall *restore value before first preset call* is a new brightness value stored which corresponds with the state before a preset is called.

- *reset to parameterised value before preset 2*: Preset 2 resets to the parameterised value it had before it was changed by the user. This can be advisable if preset 2 can be stored via the bus, see below.

Note

With the parameterisation *restore value before first preset call* or *reset to parameterised value before preset 2*, saving of the preset concerned has no effect. The saved value is not recalled but rather the parameterised function is undertaken.

Reaction on preset 2 (telegr. value 1)Options: 100/99...1/0 %

This parameter determines the brightness value which is controlled with a recall of preset 2 (= object *Call preset 1 and 2* receives a telegram value 1).

At the same time with the first call of preset 2, the state of the output is saved so that the corresponding parameterisation of the value before preset 2 can be restored.

Time to set new brightness value**“Transition time” in s [0...65,535]**Options: 0...65,535

This parameter defines the time in which a preset recall is dimmed to the new brightness value.

Preset 1 and 2 can be set via the busOptions: no
yes

This parameter enables the object *Set preset 1 and 2*. It is thus possible to store the currently set brightness value as the new preset value.

Telegram value 0 saves preset 1, whereas telegram value 1 saves preset 2.

3.2.9 Parameter window

X: Scene (1) to**X: Scene (6)**

In this parameter window all settings for implementing light scenes are undertaken.

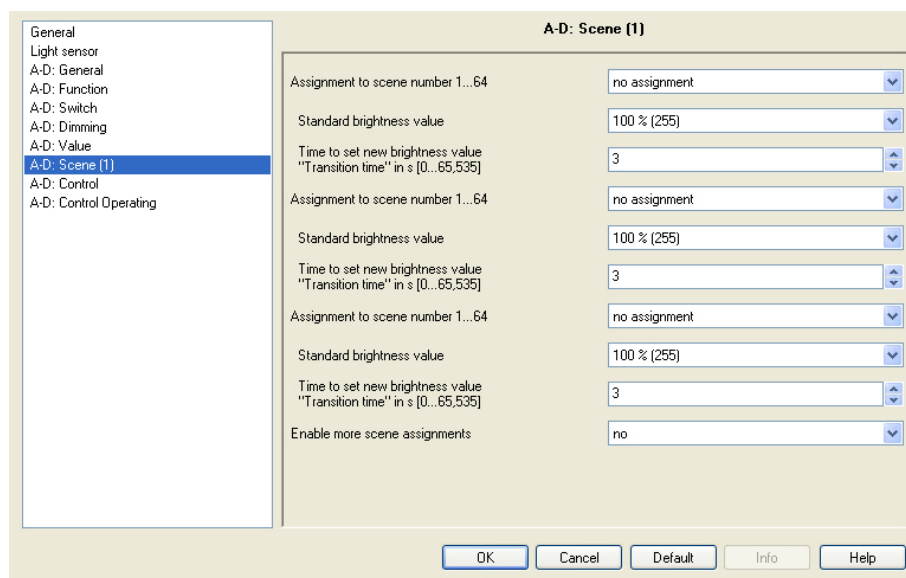

The parameter window **X: Scene (1)** appears when in parameter window **X: Function** the function 8 bit scene is parameterised with yes.

The parameter window **X: Scene (2) to (6)** for scenes 4 to 18 are each enabled in the previous parameter window **X: Scene (y)** (y = 1 to 5) with the parameter *Enable more scene assignments*.

Note

With the common parameterisation of all outputs they all feature the same scene parameters and thus switch the same brightness value on with a scene recall.

The parameterisation undertaken in this parameter window **X: Scene (y)** is only transferred to the Light Controller during a download, if in the parameter window **X: Function** the scene enable *Restore scene values with standard values* has been set to yes.

How does a scene function?

This function permits the assignment of the output to up to 18 different light scenes with corresponding programmable brightness values and transition times. If a scene number is received via the object *8 bit scene*, the stored scene value (brightness value) is recalled. Alternatively, the possibility exists to store the current brightness value as the new scene value.

For further information see: [Code table 8 bit scene telegram](#)

With the recall of light scenes the maximum and minimum values as set in the parameter window [X: Value](#) apply. The values of the value limits are set when the maximum and minimum values are overshoot or undershot. At a brightness value of 0, a switch off is always executed, independently of the parameter *Allow switching off via brightness value* parameterised in the parameter window [X: Value](#).

A scene recall as well as saving of a scene has no effect on the output with parameterised staircase lighting function.

The reaction to the scene recall with parameterised slave mode can be parameterised in the [X: Slave](#) parameter window. With the *no reaction* parameterisation a scene recall is ignored with active slave mode. The parameterisation *Slave mode can be deactivated* has the effect that the scene recall as well as a scene store command are implemented and the slave operation discontinued.

Note

The slave operation has no effect but is active in the background and can be reactivated by an ON command telegram with the value 1 to the object *Switch*. For this reason the first bit of the status byte has the value 1. Furthermore, the slave mode can be activated via the object *Activate slave mode*.

The reaction to a scene command with active light control can be parameterised in the parameter window [X: Control Operating](#).

Assignment to scene number 1...64

Options: [no assignment](#)
 Scene no. 1
 ...
 Scene no. 64

In this parameter the output is assigned to a scene number (1...64). As soon as the device receives a telegram with this scene number on the object *8 bit scene*, it will recall the corresponding scene.

Standard brightness value

Options: [100/99...1/0 %](#)

This parameter defines the brightness value which the output controls with a scene recall.

The value parameterised here can be changed. This is implemented by "setting" a scene. Via the object *Restore standard scene* the value can be reset again to the parameterised value. It can be set in parameter window [X: Function](#) with the parameter *Restore scene values with standard values*.

Time to set new brightness value "Transition time" in s [0...65,535]

Options: 0...[3...65,535](#)

With this parameter the transition time which is required until the scene brightness value is reached is set.

Enable more scene assignments

Options: no
 yes

Using this parameter a further parameter window X: Scene (y) is enabled.
Scene assignments can be made here.

Note
With the execution of the scene the defined value limits are considered in the parameter window X: Value .

3.2.10 Parameter window

X: *Charact. adj.*

In this parameter window the settings for the characteristic adjustment are undertaken.

The parameter window *X: Charact. adj.* appears when in parameter window [X: Function](#) the function characteristic adjustment is parameterised with yes.

What is a characteristic adjustment?

The characteristic adjustment enables the adaption of the dimming characteristic of the lamps (ballasts) to the sensitivity of the eyes. On the one hand with the characteristic adjustment the curve of the ballasts can be changed to suit requirements, on the other hand with constant lighting control a second lighting strip (slave) can be increased or reduced by a predetermined brightness value in dependence on a master output. In this case the brighter lighting strip should be selected as the master, i.e. the slave output is controlled as darker by the characteristic adjustment.

For further information see: [Characteristic Adjustment](#)

Number of value pairs

Options: 2/3/4

This parameter defines the number of value pairs which are used in the characteristic curve. The characteristic correction (curve) results from a maximum of four value pairs. Between the value pairs a linear interpolated curve (straight) is used.

Accordingly, additional parameters appear with which the individual X/Y values are to be entered to suit the parameterised number of value pairs.

X0 lower sensor value (input)

Options: 1...255

Y0 Adjusted brightness value (output)

Options: 1...255

X1 lower sensor value (input)Options: 1...255**Y1 Adjusted brightness value (output)**Options: 1...255

The limit and default values of the options are dependent on the number of value pairs.

In accordance with the number of value pairs, an X-value and the Y-value can be determined here. The X-value (input value) indicates the value defined by the KNX. The Y-value indicates the "true" brightness value used to control the lamps or the 1-10 V control device.

The first X-value is always defined with 1 and the last X-value with 255.

The parameterised dimming, value and control limits in the parameter window [X: Dimming](#), [X: Value](#) and [X: Control](#) are applied before the transformation, see [Functional diagram](#). Through the transformation a setting signal may result for the lamps which is therefore less than or greater than the maximum or minimum brightness values in ETS.

When feeding back the brightness value the transformation is also applied, so that values available on the KNX are directly comparable.

For further information see: [Characteristic Adjustment](#)

Note

The characteristic adjustment acts directly on the 1-10 V output and not on the objects *Master: Slave brightness value* or *Status brightness value*. This means that a characteristic adjustment must be set in the output of the Light Controller or in the external slave.

In a master/slave combination of LR/S x.16.1 and DG/S 1.1 or DG/S 8.1, a characteristic adjustment may not be transferred to the DG/S.

3.2.11 Parameter window X: Control

In this parameter window the settings for the lighting control are undertaken.

The parameter window *X: Control* is visible, if in the parameter window [X: General](#) the additional function *Light control* is parameterised for an output. As it is a default setting here, this parameter page always remains visible in the basic settings.

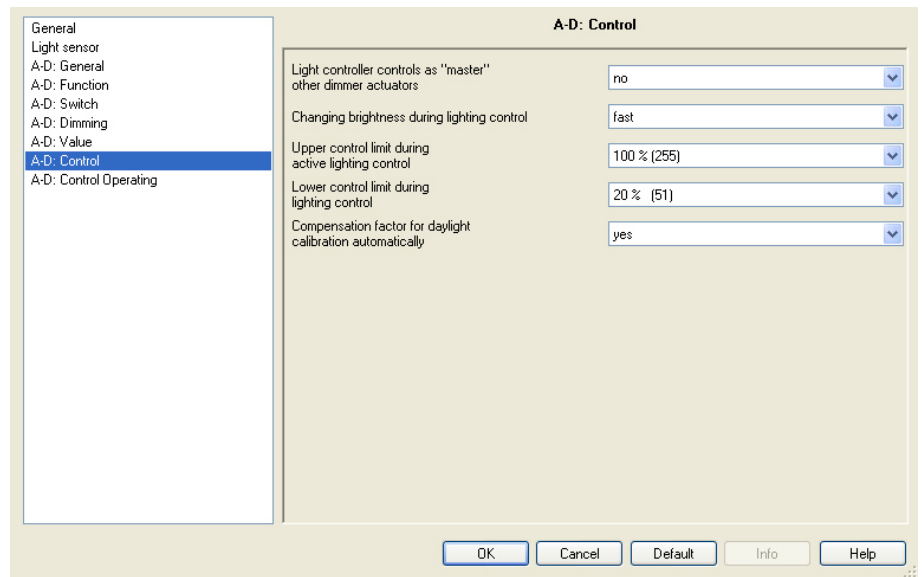

With the additional Light Control function a constant lighting control is possible with any KNX lighting components. In the simplest case they can be 1-10 V devices which are connected to the output of the LR/S x.16.1. Via the master/slave function additional luminaries can be integrated into the lighting control of the LR/S, e.g. DALI luminaries via an ABB i-bus[®] DALI Gateway DG/S or other 1-10 V luminaries via the ABB i-bus[®] Switch/Dim Actuators SD/S. Even the integration of the ABB i-bus[®] Universal Dimmer UD/S is possible. In this way highly flexible and energy efficient KNX lighting systems can be integrated into the intelligent installation systems.

How does the light control function?

Using one or more Light Sensors LF/U2.1, the brightness and luminance of the surfaces in the detection range can be detected by the Light Sensor. The control factor (actual value) results from these brightness values. Dependent on this control factor (actual value) and the setpoint value, the Light Controller will calculate a brightness value (control value) for the illumination which will keep the brightness at a fairly constant level. The setpoint value can be adjusted in a semiautomatic calibration (commissioning routine) of the control circuit.

For further information see: [Constant lighting control](#)

Rooms are lit up differently by the incidental daylight and the artificial lighting of the lamps. Not all surfaces in the rooms, e.g. walls, floor, and furniture reflect the light which falls on them in the same manner. Accordingly, even though there is an exactly calibrated constant lighting control in daily operation, deviations to the set target value may occur. These deviations may be up to +/- 100lx should the current ambient conditions in the room, and accordingly the reflection properties of the surfaces (paper, persons, reorganized or new

furniture) differ significantly from the original ambient conditions at the time of calibration.

Deviations may also occur if the Light Sensor is influenced by direct or reflected light falling on it which is not influenced or only slightly influenced by the surfaces in the detection range of the Light Sensor.”

Note

Luminaries with varying brightness characteristic curves should be avoided in control circuits. In a Light Controller control circuit a mix of 1-10 V luminaries and DALI luminaries (controlled via DALI gateways) is not possible.

This is because of the different brightness characteristic curves (linear/logarithmic) involved. The same control value, e.g. of 50 % with 1-10 V luminaries causes a brightness of 50 %. Using DALI luminaries where the characteristic curve is adapted logarithmically to the response of the human eye, a light current of 3 % results in a brightness level of about 3 %.

Because of these brightness differences at the same control value, a common lighting control (in a Light Controller control circuit) is not possible.

A switch on telegram to the object *Switch* always activates light control. The active control dims the illumination so that the difference between the Light Sensor actual value and the setpoint value is as small as possible.

After a download with parameterised Light control this is active and starts controlling.

Response of the lighting control during and after bus voltage failure:

Bus voltage failure	Control is not possible without bus voltage. The contact of the output assumes the switching position as defined in parameter window X: General with bus voltage failure.
Bus voltage recovery	Light control is active and controls the setpoint value directly after bus voltage recovery. If the switch object is written with a 0 at bus voltage recovery, the lighting will be switched off again and the light control will go to standby mode.

Control circuit principle schematic

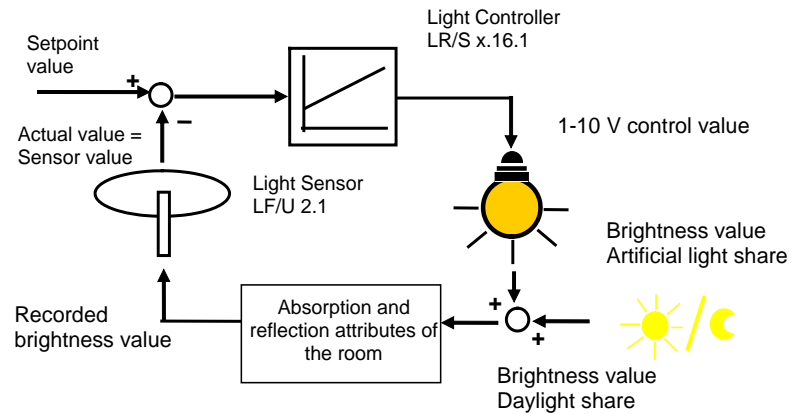

Explanations of terms

<p>Sensor value</p>	<p>This value corresponds with the physically measured value on the sensor input, which results from the room brightness detected by the Light Sensor LF/ 2.1 (luminance of the area monitored by the sensor). The sensor value does not comply with the lighting intensity (Lux value) in the room. In order to directly detect the brightness changes in the detection range of the Light Sensor, the measured value can be read out via the <i>Sensor value</i> object.</p>
<p>Actual value</p>	<p>The actual value of the control circuit is the fed back of the control path. If the controlling channel is only assigned to a Light Sensor, the actual value complies to the sensor value.</p> <p>If several Light Sensors are allocated to a channel, the actual value is determined from the sensor values. In the parameter window Light sensor you can parameterise if the smallest, the largest or the average sensor values are used for Light control calculations.</p> <p><i>For further information see: Constant lighting control</i></p>

<p>Setpoint</p>	<p>The setpoint is the decisive control value in practical application for constant lighting control.</p> <p>The Light Controller calculates the setpoint for the lighting so that the actual value to be set is as near as possible to the predefined setpoint with all room lighting conditions.</p> <p>Due to the differing ambient conditions in rooms (incidence of light, reflections and absorption conditions) this setpoint can not be easily achieved via the figure value defined in the ETS, but must rather be set using a daylight and artificial light calibration. With this calibration the lighting characteristic and the technical lighting properties of the room are automatically detected by the Light Controller in order to match the control parameter to the room.</p> <p><i>For further information see: Constant lighting control</i></p> <p>Irrespective of this calibration, overshoot or undershoot of the setpoint lighting value can occur during phases in ongoing operation of constant lighting control. These are even greater with greater differences of the reflection and absorption conditions from the original ambient conditions during the calibration procedure. A further possibility for deviations is a direct or indirect incidence of light on the Light Sensor, which does not or only barely affects the area detected by the sensor.</p>
<p>Artificial light calibration</p>	<p>With artificial light the Light Controller determines the internal actual value which results with the required setpoint value if artificial lighting is switched on exclusively. The artificial light calibration should be undertaken without the influence of daylight. The lighting should be set so that the required setpoint in the room is set exclusively using artificial lighting which is available during light control in the room.</p> <p>During the artificial lighting calibration the Light Controller automatically determines the characteristic curve of the lighting and detects the technical lighting properties of the room. The required room brightness (setpoint) is set exclusively using artificial light. The artificial lighting calibration is triggered by a telegram with the value 1 to the object <i>Calibration lighting</i>. During the calibration the Light Controller automatically progresses through the brightness characteristic from maximum to minimum brightness. In this way, the brightness characteristic of the room, the operating point and the associated parameters for light control are determined. If the brightness curve has been run through and the control parameters have been automatically set, the Light Controller switches the lighting to maximum brightness.</p> <p>Artificial lighting calibration must always be undertaken. The sequence of daylight and artificial light calibration is not in any desired order. Calibration with artificial light must be performed before calibration with daylight.</p>

<p>Daylight calibration</p>	<p>With daylight calibration the Light Controller determines the actual value which produces the required setpoint without artificial lighting. In this way the Light Controller determines the different influences of artificial lighting and natural incidence of light on the Light sensor. The daylight calibration should be performed without the influence of artificial lighting. This should be set by the change of shading of the setpoint brightness value on the reference point in the room. If this is not possible the daylight calibration can be assigned with a predefined factor via the ETS. By observing the control behaviour this factor, it should be optimised empirically so that the light control is set as exactly as possible to the target brightness level.</p> <p><i>For further information see: Constant lighting control</i></p> <p>The sequence of daylight and artificial light calibration is <u>not</u> in any desired order. Calibration with artificial light must be performed before calibration with daylight.</p>
<p>Control active/inactive</p>	<p>At any time the user can operate the light control with appropriate parameterisation using normal dimming commands, e.g. interrupt dimming, switching or scene recall in order to operate the lighting manually according to their requirements. The Light Controller is in standby mode and recommences with light control via an ON command, e.g. telegram with the value 1 on object <i>Switch</i>.</p> <p>The "actual" deactivation of the light control is implemented via the object <i>activate control</i>. With inactive light control the Light Controller acts like a normal Switch/Dim actuator. Switch commands are implemented without light control being active. Light control is only restarted if on object <i>activate control</i> a telegram with the value 1 is received.</p> <p>If the light control is activated it can be recognised using the first bit of the status byte.</p> <p>The general object <i>Status function</i> indicates if the light control actually controls, i.e. the Light Controller continuously performs a setpoint/actual comparison. The control value for the illumination is provided dependent on the control difference.</p>
<p>Master/slave operation</p>	<p>It is possible that a Light Controller also controls other dimming actuators. In this case the Light Controller (Master) also controls other Dimming Actuators (slaves) via the object <i>Brightness value of slave</i> or other channels internally directly in the LR/S.</p>

**Light controller controls as "master"
other dimmer actuators**Options: no
yes

- *yes*: The object *Brightness value of slave* is enabled.
- *no*: The Light Controller only calculates the setpoint of the connected lighting for its own output. The status of the brightness value is only sent via the objects *Brightness value* or *Brightness value/Status*.

A brightness difference between the master and the slave can be implemented by a curve correction. In this way for example, the illumination for the lighting strip at the window should be darker than the lighting strip positioned in the middle of the room. This brightness offset (characteristic correction) should be parameterised in the slave.

For further information see: [Characteristic Adjustment](#)

Note

The characteristic adjustment acts directly on the 1-10 V output and not on the objects *Master: Slave brightness value* or *Status brightness value*. This means that a characteristic adjustment must be set in the output of the Light Controller or in the external slave.

In a master/slave combination of LR/S x.16.1 and DG/S 1.1 or DG/S 8.1, a characteristic adjustment may not be transferred to the DG/S.

Changing brightness during lighting controlOptions: fast
medium
slow
individual setting

This parameter determines how fast the lighting changes when the lighting control commences.

Normally this parameter can be used to select between *fast*, *medium*, *slow* and *individual setting*. With master mode only *medium*, *slow* and *individual setting* are possible to reduce the bus load.

- *fast*: The Light Controller starts to control with fast successive (< 2 seconds) dimming steps in order to reach the setpoint as quickly as possible.
A fast correction may be necessary if the constant lighting control has the react quickly to the shade or shadows which result from a blind which closes quickly.
- *medium*: The Light Controller commences with sending dimming steps at medium speed (< 3 seconds) to achieve the setpoint.

- *slow*: The Light Controller commences with sending dimming steps at slow speed (< 4 seconds) to achieve the setpoint. The control speed is dependent on the divergence from the setpoint, see [table](#). Achieving the setpoint value is also dependent on the control increment size, refer here to [X: Control Dynamics](#).
- *individual setting*: A fine adjustment of the control can be undertaken. Control dynamics are enabled on other parameter pages. On this parameter page there are parameters used to influence the Light Controller.

Generally artificial lighting and daylight are sufficient in order to ensure exact and stable constant lighting control. If however – e.g. due to special ambient conditions and/or properties of the luminaries – it is not possible, in the parameter window [X: Control Dynamics](#), a manual fine calibration of the light control can be undertaken.

For further information see: [Function of the constant light control](#)

Upper control limit during active lighting control

Options: 100 % (255)/99 % (252)...51 % (130)/50 % (128)

This parameter defines the maximum brightness value, which the output of the Light Controller can use during light control.

If a brightness value is recalled which is larger than the upper limit, the Light Controller sets the upper limit for the output. This value is reported back on the bus.

The control limits are independent of the dim and value limits which are parameterised in the parameter windows [X: Dimming](#) and [X: Value](#).

Lower control limit during lighting control

Options: 50 % (128)/49 % (125)...20 % (51)...1 % (3)/0.3 % (1)

This parameter defines the minimum brightness value which the output of the Light Controller can use during light control. From a brightness value less than or equal to 10 % the message *Attention: illuminant charact.* is displayed.

If a brightness value is recalled which is less than the lower limit, the Light Controller sets the lower limit for the output. This value is reported back on the bus.

The control limits are independent of the dim and value limits which are parameterised in the parameter windows [X: Dimming](#) and [X: Value](#).

Note

All luminaries have a minimum dimming value to which you can dim down based on its physical properties.

If this limit is undershot, either the brightness will remain constant – e.g. with fluorescent tubes in conjunction with ballasts – or the luminaries will switch off, e.g. incandescent bulbs. As it is a physical property of the luminaries, sometimes when in combination with a ballast, it is not possible that this minimum dimming limit can be reduced further by a smaller value set in the parameterisation. Furthermore, some luminaries will no longer light with constant brightness underneath 10 %. For this reason with a brightness value less than or equal to 10 %, the message *Attention: illuminant charact.* is displayed.

If a lower control limit ≤ 10 is set, the following parameter appears:

Allow switching on/off during lighting control

Options: no, illumination is always on
 switching on only via going up
 switching on and off via going up/down

These parameters define if switch off or switch off and switch on of the lighting during light control is allowed by the Light Controller.

- *no, illumination is always on:* The lighting is not switched on or off independently by the light control.
Switching on is implemented by an ON command via the *Switch* object. This can be undertaken by a pushbutton or automatically by a presence detector.
In this way a problematic or extended period of lighting up the luminaries can be avoided.
This is the case particularly when ignition takes a few seconds.
This causes interference and damages the service life of the luminaries.
- *switching on only via going up:* The Light Controller switches off the light, however the lighting must be implemented manually via an ON command.
- *switching on and off via going up/down:* In this way it is possible to parameterise switch off dependent on the setpoint deviation. In this way continuous switch on and switch off is avoided. This causes interference and damages the luminaries.
The following parameter appears:

Switch off if control deviation is greater than [0...30]Options: 0/1/2...5...29/30

When the lower control limit is reached the Light Controller normally switches off the lighting immediately. This avoids abrupt changes in the brightness or in certain circumstances that the lighting is switched back on immediately. In order to avoid continuous switch on and off of the lighting a divergence can be parameterised with this parameter.

The Light Controller maintains the minimum control limit until the calculated setpoint deviation has exceeded the parameterised value. Only then is the lighting switched off.

This ensures that the existing brightness level is so high during switch off so that the Light Controller does not immediately switch the lighting back on.

The Light Controller calculates the divergence from the current sensor value of the Light Sensor and the brightness which would result in switching on the artificial lighting. This artificial lighting brightness level has been automatically recorded and saved during artificial lighting calibration of the Light Sensor.

Note

The Light Controller can automatically switch off the luminaries when the lower control limit is reached. Before the Light Controller switches off the illumination, it determines if the brightness in the room is sufficiently high enough so that the required setpoint will not be reached when the lighting is switched off. For this purpose, the measured actual value of the artificial lighting share of the lower limit and the value of the parameter *Switch off if control deviation is greater than* are subtracted. If the difference is greater than the setpoint, the Light Controller switches off the lighting.

The artificial lighting share is determined by the Light Controller during implementation of the artificial and daylight calibration.

Compensation factor for daylight calibration automaticallyOptions: no
yes

With this parameter the factor for the daylight compensation can be entered manually in the ETS. This factor considers the evaluation of the artificial lighting and the natural incidence of light using the Light Sensor. Generally this factor is determined automatically by the Light Controller during the daylight calibration, refer to [Commissioning/calibration of the constant lighting control](#).

- *no*: This should be selected if no daylight calibration is to be performed, e.g. the natural brightness is not sufficient or no shading possibilities are available to set the setpoint during daylight. Both parameters are enabled:

Factor for daylight compensation in % [0...99]Options: 0...35...99

A larger value compensates more for natural light. This means that artificial light has a higher weighting which also means that more artificial light is added and that the light is switched off later as a result. The room will remain brighter than the setpoint brightness.

A smaller value compensates less for natural light. This means that artificial light has a lower weighting and that less artificial light is added. The setpoint value tends to be slightly undershot and the artificial light is switched off earlier.

In practical usage it has been demonstrated that – depending on the ambient conditions – a factor of between 30 and 50 generally provides the best results in most cases.

Restore factor for daylight compensation during downloadOptions: no
yes

This parameter defines if the factor for daylight compensation is overwritten with the value from the ETS.

- *yes*: With a download the value stored in the Light Controller for daylight compensation is overwritten with the value set in the ETS.
- *no*: The factor is not overwritten during download. This is useful for example, if you want to avoid that the values which have been determined over the course of many attempts in then Light Controller are not overwritten by mistake and that a renewed calibration is required.

3.2.12 Parameter window X: Control Dynamics

The parameter window *X: Control Dynamics* is enabled if in parameter window *X: Control* the parameter *Changing brightness during lighting control* with the option *individual setting* has been selected.

The control dynamics influence the behaviour of the control function. Generally this fine tuning of the control circuit is not necessary.

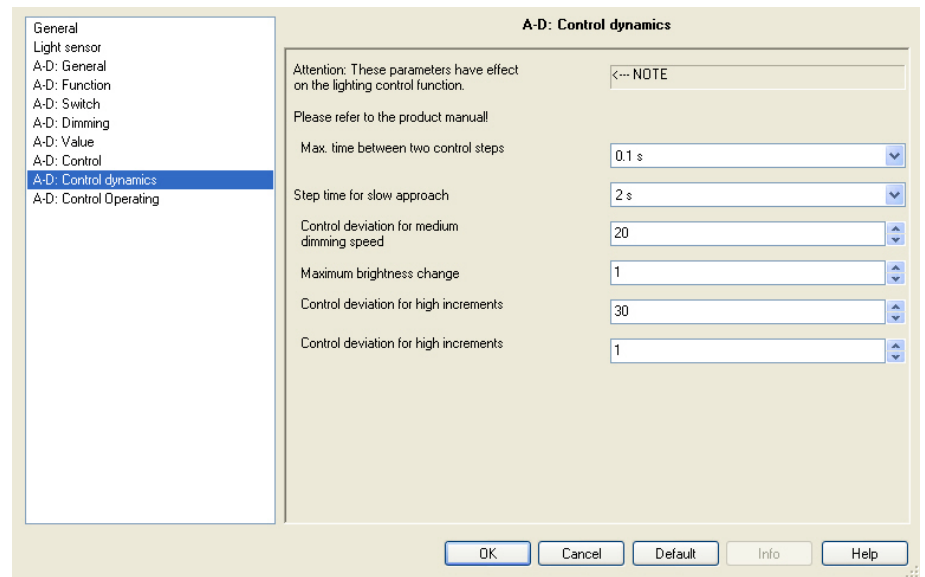

Normally the artificial lighting and daylight calibration with the preset control dynamic parameters is sufficient to set good and stable constant lighting control. If however this is not the case and it is not possible to set stable lighting control due to special conditions in the room, e.g. delays in the lighting circuit, manual fine tuning of the lighting control can be undertaken with these enabled control dynamic parameters.

Max. time between two control steps

Options: as fast as possible
0.1/0.2...1*...9/2.0 s

* Default value if control parameterised as a master

This parameter defines the step time of a control step in the start up phase. The smaller the step time, the faster that the control steps are applied with their increment size (brightness). The Light Control quickly approaches the setpoint.

This step time is used if the actual value still varies greatly from the setpoint. Otherwise the step time for slow approach is used.

For further information see: [Constant lighting control](#)

Note

The step time may not be selected to be less than the delay of the control circuit. This is comprised of the detection speed of the Light Sensor and the dynamic response of the luminaries. If the step time is less than the delay of the control circuit, the Light Controller will set the brightness beyond the target value and oscillation will occur in the lighting control. In this case the change in brightness due to a control step will only be achieved after sending the next control step.

Step time for slow approach

Options: 1/2...4*...9/10 s

* Default value if control parameterised as a master

This parameter defines the step time of a control step when approaching the actual value. The larger the step time, the longer until the brightness of the control step is set. The Light Control slowly approaches the setpoint. This step time is used when the actual value is relatively near to the setpoint. Otherwise the step time for fast approach is used.

For further information see: [Constant lighting control](#)

Control deviation for medium dimming speed

Options: 10...20...50

This value represents the control divergence (difference between the setpoint and actual value) at which there is a change between fast and slow approach to the setpoint. Above this control divergence there is a fast approach (small increments of the control step), below it there is slow approach with a large step time.

At the same time the response of the lighting control is slower with larger values, whereby they do not respond too sensitively to brightness changes caused by clouds or temporary changes, e.g. persons in the detection area of the Light Sensor in the room.

For further information see: [Constant lighting control](#)

Maximum brightness change

Options: 1...5*...10

* Default value if control parameterised as a master

This value defines the maximum increment size of a control step. This is the maximum brightness difference that the Light Controller can perform per control step. In this way the Light Controller can approach the setpoint value in large steps. There is a danger however that the setpoint is exceeded and the light control circuit will be unstable.

For further information see: [Constant lighting control](#)

Control deviation for high increments (max. control step)

Options: 10...30...255

This value represents the control divergence (difference between the setpoint and actual value) up to which the maximum increment can be controlled.

In this way, the Light Controller can approach the setpoint value in fast steps. The increment should always be considered in conjunction with both approach parameters. Both parameters change the control dynamics and the approach speed to the setpoint value.

For further information see: [Constant lighting control](#)

Control deviation for high increments

Options: 0...1...30

This value defines a range around the setpoint at which no light control occurs. Only after the actual value (brightness value) is again outside this range does light control recommence. In this way continuous control with the respective changes in brightness is avoided. This generates a smoother and less abrupt response and considerably reduces the bus load with a master/slave control.

For further information see: [Constant lighting control](#)

3.2.13 Parameter window *X: Control Operating*

The parameter window *X: Control Operating* is enabled if in parameter window [X: General](#) the parameter *Select additional function* is selected with the option *Light control*. As it is a default setting here this parameter page always remains visible in the control mode.

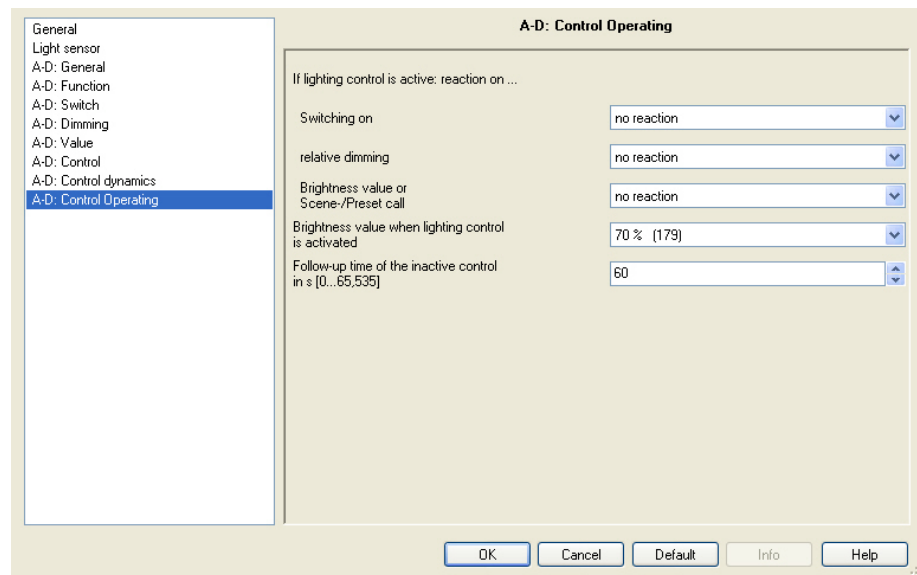

In this parameter window the response of the light control to the switch, dim, brightness, scene or preset command is defined.

The Light control is activated by an ON command (receipt of a telegram with the value 1 on the object *Switch* or *Switch/Status*). An OFF command always causes switch off of the lighting and the light control. The light control is in standby mode and recommences with light control via an ON command or when a telegram with the value 1 is again received on the *activate control* object.

Note

The light control can assume three operating states:

Control is not active: The light control has been deactivated via its object *activate control* (telegram has been received with value 0). In this state the Light Controller acts like a normal Switch/Dim actuator. ON commands do not cause the light control to start. Only after a telegram with the value 1 has been received on the object *activate control* is it possible to start the light control. Please observe that after the telegram with the value 1 has been received the light control will start to control. An output of the Light Controller can only assume one of the three additional functions *Light control*, *Staircase light* or *Slave mode*. If this additional function is active, it is displayed via the first bit of the object *Status byte*.

Control is in standby mode: The light control is active but has however been ended, e.g. by the OFF command. The light control still remains active in the background and starts again with control after an ON command.

Control controls: The Light controller controls and adjusts the lighting so that the setpoint brightness is set. The status indicating if the light control operates is displayed via the *Status function* object.

If lighting control is active: reaction on ...

With these three parameters you can set how an output of the Light Controller reacts with active lighting control if the following telegrams have been received:

Switch on	Receipt of the telegram value 1 on the objects <i>Switch</i> or <i>Switch/Status</i>
Relative dimming	Receipt of a telegram on the object <i>Relative dimming</i>
Brightness value, preset or scenes	Receipt of a telegram on the objects <i>Brightness value</i> or <i>preset or scene recall</i>

Switching on

Options: no reaction
 deactivate lighting control
 Restart control with brightness value

- *no reaction:* An ON command on the object *Switch* has no effect on the lighting and the lighting control.
- *deactivate lighting control:* By an ON command via the objects *Switch* or *Switch/Status* the light control is interrupted. The light control can be reactivated by an ON telegram or via the object *activate control*.
- *Restart control with brightness value:* With activated light control the switch on brightness and light control are restarted with an ON command.

Note

An OFF command (telegram with the value 0) to the object *Switch* or *Switch/Status* always causes a switch off of the lighting and the light control. The light control is in standby mode and recommences with light control via an ON command (telegram with the value 1) received on the object *Switch* or *Switch/Status* or *activate control*.

Relative dimming

Options: no reaction
 deactivate lighting control
 setpoint = new sensor value (temporary)

- *no reaction*: A dimming command to the object *relative dimming* has no effect on the lighting and the lighting control.
- *deactivate lighting control*: With a dimming command via the object *relative dimming* the lighting control can be interrupted. The light control can be reactivated by an ON telegram or via the object *activate control*.
- *setpoint = new sensor value (temporary)*: The new sensor value (current brightness) is accepted as a temporary setpoint. After a brief interruption – until the temporary setpoint is accepted – the light control will continue with the new setpoint. The old setpoint is restored at the next activation of the light control, e.g. switch on via object *Switch* or via the object *activate control*.

Brightness value or preset or scene recall

Options: no reaction
 deactivate lighting control

- *deactivate lighting control*: The light control can be interrupted by a brightness command, a scene recall or by a preset command. The lighting control switches to the standby mode. The received brightness value command is implemented. The light control can be reactivated by an ON telegram or via the object *Switch*.
- *no reaction*: A brightness command, a scene recall or a preset command has no effect on the lighting and the lighting control..

Brightness value when lighting control is activated

Options: 100 % (255)
 last brightness value
 99 % (252)/...70 % (179)/2 % (5)/1 % (3)

Using this parameter the brightness value which is set immediately after activation of the light control can be defined. Commencing at this value the lighting is gradually controlled up to the setpoint.

The last brightness value is the constant brightness value which existed when light control was switched off. If no last brightness value is stored, a 100 % or maximum brightness is assumed.

Follow-up time of the inactive control in s [0...65,535]Options: 0...60...65,535

If constant lighting control is deactivated or interrupted by the user, e.g. by manual dimming, the current brightness value is stored for the duration of the follow up time. The follow up time commences with the deactivation of the light control. If the lighting is switched back on within the follow-up time, the light control is not reassumed and the lights are controlled with the stored brightness value. If the lighting is switched back on after the follow-up time, light control is reactivated and the Light Controller assumes control.

If constant lighting control is switched off the follow-up time is not activated. Lighting control is interrupted.

This function should re-establish the same level of lighting for persons who leave the room and return after a brief period. It is particularly useful if the lighting is automatically switched by a presence or motion detector.

3.2.14 Parameter window X: Slave

The parameter window *X: Slave* is enabled if in parameter window [X: General](#) the parameter *Select additional function* is set with the option *Slave mode in lighting control*.

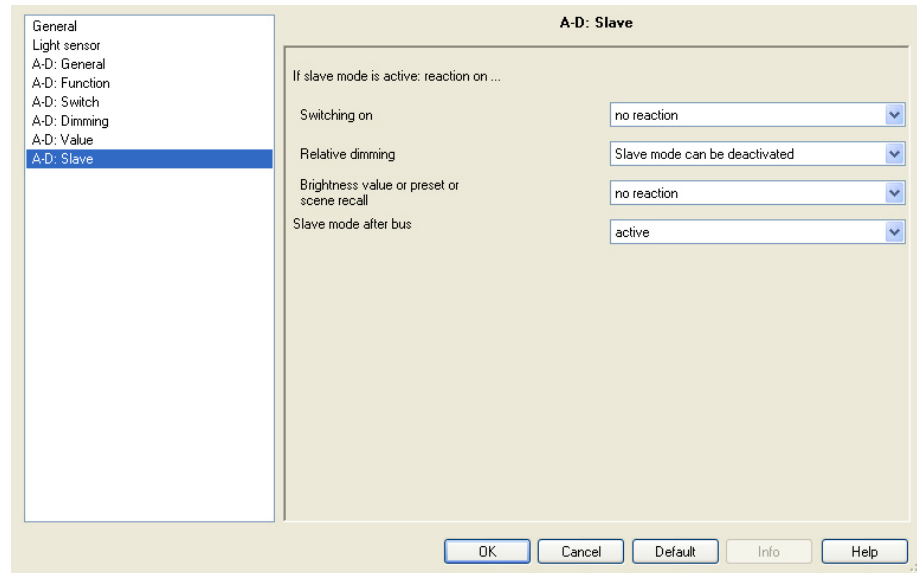

In slave mode the output of the Light Controller follows the brightness value provided by the master output via the object *Brightness value of slave*. In this way the output of another ABB i-bus® device can be integrated into the constant lighting control of the Light Controller.

With the Light Controller it is possible to directly control a slave output internally using a master output on the Light Controller. The brightness value is assigned directly to the slave output in the Light Controller. This will avoid unnecessary telegram traffic on the KNX. Of course the slave can also be controlled via the external object *X: Brightness value of slave*. For this purpose in the parameter window [X: Slave](#) you can find the parameters *Slave is controlled via* to set to *External via object*.

If in the following the object *Switch* or *Brightness value* are mentioned, it also applies for the objects *Switch/Status* or *Brightness value/Status*.

The following three parameters define how an output should react with active slave mode.

**If slave mode is active:
reaction on...****Switching on**

Options: no reaction
 Slave mode can be deactivated

If the slave mode is active, this parameter can be used to define the reaction to an ON command (telegram with value 1 to object *Switch* or *Switch/Status*) can be defined.

- *no reaction*: With active slave mode switch on does not produce a reaction. The command is ignored.
- *Slave mode can be deactivated*: With active slave mode it is ended with an ON command and the Light Controller undertakes the switch command. The slave mode is latent and waits until a renewed activation (standby state) via the object *Activate slave mode* or via a telegram with the value 1 to the object *Switch*.

As the slave mode is only in standby, the corresponding bit 0 in the status byte remains active and has the value 1. The status of the additional function in object no. 3 *Status function* assumes the value 0 at the respective bit position. The additional function no longer operates and is in standby mode or is fully deactivated.

Note

The reaction to an OFF command (telegram with value 0 to object *Switch* or *Switch/Status*) can not be parameterised. An OFF command always ends the slave mode.

Even with deactivated light control (telegram with the value 0 to the object *activate control*) the brightness value is sent by the master via the object *Brightness value of slave*. In this way the lighting combination (master/slave) is always controlled as a unit even with deactivated light control.

The master/slave unit is separated, for example, by deactivation of the slave mode (telegram with the value 0 to object *Activate slave mode*). If the slave mode is deactivated, the brightness values received from the slave via the object *Brightness value of slave* are not switched to its output.

Relative dimming

Options: no reaction
 Slave mode can be deactivated

If the slave mode is running, this parameter can be used to define the reaction to a dim command (receipt of an telegram on the object *Relative dimming*).

- *no reaction*: With active slave mode the dimming command does not produce a reaction. The command is ignored.
- *Slave mode can be deactivated*: With active slave mode it is ended with a dimming command and dimming is undertaken. The slave more is latent and waits until a renewed activation via the object *Activate slave mode*.

Brightness value or preset or scene recall

Options: no reaction
Slave mode can be deactivated

If the slave mode is running, this parameter can be used to define the reaction to a brightness value (receipt of a telegram on the object *Brightness value or preset or scene recall*) (receipt of a telegram on one of the objects *Preset... or 8 bit scene*).

- *no reaction*: With active slave mode *Brightness value or preset or scene recall* does not produce a reaction. The commands are ignored.
- *Slave mode can be deactivated*: With activated slave mode this is ended with a *Brightness value or preset or scene recall* and the commands are executed. The slave more is latent and waits until a renewed activation via the object *Activate slave mode*.

Slave mode after bus voltage recovery

Options: active
inactive

This parameter defines if slave mode is *active* or *inactive* after bus voltage recovery. If the slave function is active, the brightness value on the object *Brightness value of slave* is recalled and set after bus voltage recovery.

Note

Parameterisation in parameter window [X: General](#):

In this window you can set that an ON command (switch object is written with the value 1) for the output is initiated after bus voltage recovery. If in the parameter window [X: Slave](#) the slave mode after bus voltage recovery is parameterised as active, and at the same time the reaction of the slave mode is parameterised as deactivated at switch on, the slave is immediately deactivated again by an ON command.

This means that the effect on the parameter *Value of object "Switch" on bus voltage recovery (X: General)* has a higher priority than the effect of the parameter *Slave mode after voltage recovery* described here.

If in the parameter window [X: General](#) the output has been parameterised as a slave and if the outputs are parameterised individually, a further parameter appears:

Slave is controlled via

Options: External via object
 Output x
 Output y
 Output z

X, y and z are the three outputs of the Light Controller which can be parameterised as masters. On a 2-fold Light Controller only the second output is available for use as a master.

Using this parameter you can determine whether the Light Controller controls a slave output internally or directly via a master output in the Light Controller. The brightness value in this case is assigned directly to the slave output in the Light Controller. This will avoid unnecessary telegram traffic on the KNX. Of course the slave can also be controlled via the external object *X: Brightness value of slave*. For this purpose in the parameter window [X: Slave](#) you can find the parameters *Slave is controlled via* to set with the option *External via object*.

The internal master function is selected if one of the options *Output x*, *Output y* or *Output z* is selected.

It must be considered that the selection of an output is offered when it is no longer parameterised as a master.

3.2.15 Parameter window X: Staircase light

The parameter window *X: Staircase light* is enabled if in parameter window *X: General* the parameter *Additional function* is set with the option *Staircase light*.

Note

The staircase light can not always be combined with a constant lighting control.

For further information see: [Communication objects](#) and [staircase light](#)

A-D: Stairc. fct.	
Brightness value after switching on	100 % (255)
Time duration in sec [0...65,535]	180
After staircase time dimming to basis brightness	0 % (off)
Time for dimming down in s [0...65,535]	60
Extending staircase lighting by multiple operation ("pumping up")	yes (retriggerable)
Reaction on switching off via object "switch"	no reaction
Brightness value during permanent DN	100 % (255)
Restart of staircase time after end of permanent DN	yes
Warning during dimming down (object "Warning stairc. lighting")	yes

Buttons: OK, Cancel, Default, Info, Help

Brightness value after switching on

Options: 100/99...1/0 % (OFF)

This parameter defines the brightness value of the lighting during the staircase lighting time (0...100 %). If the brightness value is less than the minimum dimming value, the minimum dimming value is set.

Time duration in sec [0...65,535]

Options: 0...180...65,535

This parameter determines the time duration for which the staircase lighting is switched on with the staircase light brightness.

After staircase time dimming to base brightnessOptions: 100/99...1/0 % (OFF)

This parameter determines the base brightness which is continuously controlled after the staircase lighting time .

Example

This option is used for example, for night time operation where the hall lighting should remain switched on with a minimum brightness level value. If someone enters the hall the light is switched on to a defined brightness via a presence detector for the staircase light time.

Time for dimming down in s [0...65,535]Options: 0...60...65,535

The parameter defines the speed used for dimming down at the end of the staircase lighting time.

The dimming time relates to the minimum dimming value or the basis brightness, depending on the value that is reached first. Using this logic the light is always dimmed for the entire prewarn time, in order to provide a sufficiently long warning before the staircase light is switched off.

Extending staircase lighting by multiple operation (“pumping up”)

Options: no (not retriggerable)
 yes (retriggerable)
 up to max. 2x staircase lighting time
 up to max. 3x staircase lighting time
 up to max. 4x staircase lighting time
 up to max. 5x staircase lighting time

If a further ON telegram is received during the staircase lighting time, the remaining staircase lighting time can be extended by a further period. This is possible until the maximum time has been achieved. The maximum staircase lighting time can be programmed and it can be set to 1, 2, 3, 4 or 5-fold time of the staircase lighting time. If a portion of the "pumped up" time has already elapsed, it can again be pumped up to the maximum value. The parameterised maximum staircase lighting time may not however be exceeded. The warning time is not modified by the pumping up action.

- *no (not retriggerable)*: The receipt of a switch on telegram during the running staircase lighting time is ignored. The staircase lighting time continues without modification to completion. If an ON telegram is received during the dimming time, the staircase light time is retriggered.
- *yes (retriggerable)*: The staircase light time is reset each time by an ON telegram and starts to count again each time.

**Reaction on switching off via
object "switch"**

Options: no reaction
 switch on basis brightness
 dimming on basis brightness
 switch off

- *no reaction*: Switch off telegrams are ignored.
- *switch on basis brightness*: The lighting switches to basis brightness as has been parameterised in the parameter *After staircase time dimming to base brightness*.
- *dimming on basis brightness*: With switched on lighting the dimming phase is started with the corresponding dimming time and basis brightness.
- *switch off*: The lighting is switched off.

If *Permanent ON* is active the switch OFF telegram is ignored and not processed.

Brightness value during permanent ON

Options: 100/99...1/0 % (OFF)

This parameter is used to set the brightness of the lighting which is to be retained during the *Permanent ON* phase (object *Permanent ON* the value 1).

Note

Forced operation and blocking have a higher priority!

**Restart of staircase time after
end of permanent ON**

Options: no (dim down immediately)
 yes

- *no (dim down immediately)*: The lighting switches off if *Permanent ON* is ended.
- *yes*: The lighting remains on and the staircase lighting time restarts.

**Warning during dimming down
(object "Warning stairc. lighting")**

During the dimming time additional warning is possible by setting the object *Warning staircase lighting* to 1. Thus for example, a pushbutton LED can be controlled or a warn signal initiated which informs concerning the impending staircase lighting switch off.

3.3 Communication objects

3.3.1 General

Number	Object Function	Name	Length	C	R	V	T	U
0	In Operation	General	1 bit	C	R	-	T	-
3	Status function	General	1 Byte	C	R	-	T	-

No.	Function	Object name	Data type	Flags
0	In operation	General	1 bit (EIS 1) DPT 1.002	C, R, T

In order to regularly monitor the presence of the Light Controller on the KNX, a monitoring telegram can be sent cyclically on the KNX. The communication object is enabled, if the parameter *Send object "in operation"* in the parameter window *General* is set to send. The send value of the telegram can be parameterised.

In the parameter window *General* you can parameterise if and at which intervals a telegram with the value 1 or 0 is sent via the *In operation* object.

3	Status function	General	1 byte Non EIS Non DPT	C, R, T
---	-----------------	---------	---------------------------	---------

This object is always visible so that the state of the additional functions *Light control*, *Staircase light* and *Slave mode* can always be queried, see [Status function table](#).

The status refers to the state of the additional functions, i.e. is the staircase lighting time running, is the light controller running or does the slave receive a brightness value via the object *Brightness value of slave*.

The state does not initially have anything to do with the activation of the additional functions via the object *Activate xy* (xy = light control, slave mode for light control or staircase lighting time).

This state is indicated in the first bit of the status byte object (No. 34, 59, 84, 109). An output can only change a state (runs, control) when the additional function is activated.

Every bit defines the state of an output. The first bit belongs to output A, the second bit to output B. For the four-fold Light Controller the third and fourth bits define the states of outputs C and D:

- Telegram value:
- 0 = Additional function latent, it is in standby mode and is not undertaken or it is fully deactivated.
 - 1 = Control controls, staircase light runs, slave mode operates. Extra function is active.

For further information see: [Code table](#)

Note
<p>If forced operation is activated when an additional function is operational, e.g. Permanent ON with staircase light, this forced operation is carried out. The normal operation continues to run in the background so that the output reassumes its previous function immediately after switch off of the forced operation. For this reason the respective function of the object <i>Status function</i> remains 1 (running). Only when the additional function has really been completed is it possible to set the respective bit in the object <i>Status function</i> to 0 (not running).</p> <p>The information regarding if the additional function is actually active can be queried via the first bit of the status byte of the output, or directly via the respective object <i>Activate xy</i> (xy = light control, slave mode for light control or staircase lighting time). If the additional function is deactivated (by sending of a 0 to the object <i>activate xy</i>), the respective bit of the object <i>Status function</i> is automatically 0.</p>

1, 2, 4...9	Free	not assigned		
-------------	------	--------------	--	--

3.3.2 Per output

Number	Object Function	Name	Length	C	R	V	T	U
10	Switch	Output A	1 bit	C	-	W, T	-	-
11	Status switch	Output A	1 bit	C	R	-	T	-
12	Relative dimming	Output A	4 bit	C	-	W, -	-	-
13	Brightness value	Output A	1 Byte	C	-	W, T	-	-
14	Status brightness value	Output A	1 Byte	C	R	-	T	-
15	Dimming speed 0...100 %	Output A	2 Byte	C	R	W, -	-	U
16	Forced operation	Output A	2 bit	C	-	W, -	-	-

With corresponding parameterisation the objects *Switch/Status* and *Brightness value/Status* appear.

Number	Object Function	Name	Length	C	R	V	T	U
10	Switch	Output A	1 bit	C	-	W, T	-	-
12	Relative dimming	Output A	4 bit	C	-	W, -	-	-
13	Brightness value	Output A	1 Byte	C	-	W, T	-	-
14	Status brightness value	Output A	1 Byte	C	R	-	T	-
15	Dimming speed 0...100 %	Output A	2 Byte	C	R	W, -	-	U
16	Forced operation	Output A	2 bit	C	-	W, -	-	-

No.	Function	Object name	Data type	Flags
10, 35, 60, 85 ¹⁾	Switch	Output A	1 bit (EIS 1): DPT 1.001	C, W, T
<p>The object is always enabled in order to immediately switch on and off without parameterisation.</p> <p>This object is used for switching an output ON/OFF.</p> <p>Telegram value: 0 = OFF command: relay opens 1 = ON command: relay closes</p> <p>If the staircase light function is activated, the staircase light is switched on via this object. An inversion is not intended.</p> <p>The relay only always receives a switch impulse, if a calculated contact change is required, i.e. a repeated switch command is not carried out again. .</p> <p>This behaviour should be considered particularly with a manual operation of the relay. This action is not recognised by the Light Controller and is therefore not considered in the contact calculation. For this reason a manually switched off contact can only be switched on via the bus if an off command has been received via the bus beforehand.</p> <p>It is possible to parameterise that the switch status is fed back via the object <i>Switch</i> or via the object <i>Switch/Status</i>. Generally the feedback uses a separate object <i>Status switch</i> for this purpose. In the parameter window X: General you can parameterise if a common object or two separate objects are available for the switch and feedback. An inversion of the switch status can also be parameterised.</p>				

¹⁾ The numbers of the objects apply for outputs A to D.

No.	Function	Object name	Data type	Flags
10, 35, 60, 85¹	Switch/Status	Output A	1 bit (EIS 1) DPT 1.001	C, R, W, T
<p>The object is enabled if in the parameter window X: General the feedback is parameterised via the object <i>Switch/Status</i>.</p> <p>This object has the same functions and characteristics as the object <i>Switch</i>. The status is additionally fed back. If only one common object for switching and feedback is used, no inversion of the feedback is possible.</p> <p>Telegram value: 0 = OFF command: relay opens 1 = ON command: relay closes</p> <div style="border: 1px solid black; padding: 5px; margin: 10px 0;"> <p>Note</p> <p>If several groups are assigned to the object <i>Switch/Status</i>, the status address should be set as the sending address. In a KNX groups with several status feedback messages, it is useful to allow just a single group member to feedback the status.</p> </div>				
11, 36, 61, 86¹	Status switch	Output A	1 bit (EIS 1) DPT 1.001	C, R, T
<p>This object is released if the parameter <i>Status response of the switching state</i> in the parameter window X: General has the value yes: via a separate object <i>Switch status</i>.</p> <p>The object value directly indicates the current contact position of the switching relay. An inversion of the status value as when sending the status telegram can be parameterised. The status can only be sent with a change, or with a change and triggered by a switch command. The parameterisation <i>if value change and triggered by switch command</i> which is sent with a change and also with the receipt on every input of a telegram on the object <i>Switch</i> or <i>Switch/Status</i>. Other switch actions, e.g. by scene or preset recalls only trigger sending of the status with a status change.</p> <p>Manual switching is not detected so that in this case the status message does not correspond with the contact position.</p>				
12, 37, 62, 87¹	Relative dimming	Output A	4 bit (EIS 2) DPT 3.007	C, W
<p>The object is always enabled in order to enable dimming without parameterisation.</p> <p>The relative dimming telegram for the corresponding output is received via this object. It is a dim command (BRIGHTER, DARKER, STOP). After a start command is received the brightness value is changed in the defined direction with the parameterised speed. If a stop command is received before the dim process ends or the maximum or minimum dimming value is reached, the dimming process is interrupted and the received brightness value is retained.</p> <p>Dim values which are above or below the max. or min. dimming values will not be received, the parameterised max. or min. dimming values remain as they are with further dimming.</p>				

No.	Function	Object name	Data type	Flags
13, 38, 63, 88 ¹	Brightness value	Output A	1 byte (EIS 6) DPT 5.001	C, W, T
<p>The object is always enabled in order to enable a brightness value without further parameter setting.</p> <p>A defined brightness value for the corresponding output is received via this object. It can be parameterised whether this value is set abruptly or dimmed to with a dimming speed. This can be set on the parameter window X: Switch.</p> <p>Brightness values which are above or below the predefined max. or min. brightness values are not set. The respective value limit is set. Furthermore, you can set the brightness value of the output used to switch on (value = x %) or off (value = 0 %).</p> <p>Telegram value: 0 = OFF, or. min. value limit, if it is parameterised</p> <p style="padding-left: 100px;">... 255 = 100 %</p> <p>It is possible to parameterise that the status of the brightness value is fed back via the object (<i>Brightness value/Status</i>). Generally a separate object <i>Status brightness value</i> is used which can be enabled in the parameter window X: General via a parameter.</p>				
13, 38, 63, 88 ¹	Brightness / Status	Output A	1 byte (EIS 6) DPT 5.001	C, R, W, T
<p>The object is enabled if in the parameter window X: General the parameter <i>Status response of brightness value</i> is set to yes: via object <i>Brightness value/Status</i> and the object is parameterised via object <i>Brightness value/Status</i>.</p> <p>This object has the same functions and characteristics as the object <i>Brightness value</i>. The status is additionally fed back.</p> <p>Telegram value: 0 = OFF, or minimum value limit</p> <p style="padding-left: 100px;">... 255 = 100 %</p> <div style="border: 1px solid black; padding: 5px; margin: 10px 0;"> <p>Note</p> <p>If several groups are assigned to the object <i>Brightness value/Status</i>, the status address should be set as the sending address. In a KNX groups with several status feedback messages, it is useful to allow just a single group member to feedback the status.</p> </div>				
14, 39, 64, 89 ¹	Status brightness value	Output A	1 byte (EIS 6) DPT 5.001	C, R, T
<p>This object is released if the parameter <i>Status response of brightness value</i> in the parameter window X: General has the value yes: <i>via separate obj. Status brightness value</i>.</p> <p>The object is used to feedback the brightness value which is currently output. The object value updates only at the completion of a switching or dimming process.</p> <p>It is possible to parameterise when a status telegram is sent. The status can only be sent <i>only after changing</i> or with <i>if value change and triggered by brightness command</i>. The parameterisation <i>if value change and triggered by brightness command</i> means that with a change and also with the receipt of a telegram on the object <i>Brightness value</i>, the status is sent. Other brightness values, setting commands, e.g. by scene or preset recalls only trigger sending of the status with a status change.</p>				

¹⁾ The numbers of the objects apply for outputs A to D.

No.	Function	Object name	Data type	Flags
15, 40, 65, 90¹⁾	Dimming speed 0...100 %	Output A	2 byte (EIS 10) DPT 7.005	C, R, W
<p>This object is enabled if in parameter window X: Dimming the parameter Dim period changeable via object (Object: Dimming speed 0...100 %) is set to yes.</p> <p>Via this object the dimming speed for relative dimming can be set. The dimming speed for switching, setting values or staircase lighting function will not be influenced. The value (counter value) is represented in seconds and relates to the complete dimming range between 0 % and 100 %. After bus voltage recovery the value set via the bus is overwritten by the value parameterised in the ETS.</p>				
16, 41, 66, 91¹⁾	Forced operation	Output A	2 bit (EIS 8) DPT 2.001	C, W
<p>This object is enabled if in parameter window X: Function the function forced operation 2 bit control is enabled.</p> <p>Output X can be forcibly operated via this object (e.g. by a higher-level control). The object value directly defines the forced position of the output:</p> <p>Telegram value: 0 or 1 = The output is not forced operated, an existing forced operation is removed.</p> <p> 2 = The output is forcibly switched OFF. The forced operation is active.</p> <p> 3 = The output is forcibly switched ON with the parameterised brightness value. The forced operation is active.</p> <p>The brightness value of the output is calculated during forced operation, but is not however displayed. Dimming speeds are not considered with the calculation, i.e. in the background the immediate end values are stored. After the completion of forced operation the brightness values calculated in the background are set.</p> <p>A dim, scene or preset recall will not be reinitiated.</p> <p>The staircase lighting function continues to operate in the background and after forced operation assumes the state which it would have without forced operation.</p> <p>If the Light Controller had control before forced operation, lighting control will be reassumed after forced operation with the switch on value.</p> <p>After a download the object <i>Forced operation</i> has the value 0. The forced operation is not activated.</p> <p>Forced operation has a higher priority than blocking an output.</p> <p>The state of the bus voltage can be parameterised.</p> <p><i>For further information see: Parameter window X: Function</i></p>				

¹⁾ The numbers of the objects apply for outputs A to D.

No.	Function	Object name	Data type	Flags
16, 41, 66, 91 ¹⁾	Forced operation	Output A	1 bit (EIS x) DPT 1.003	C, W
<p>This object is enabled if in parameter window X: Function the function <i>forced operation 1 bit control</i> is enabled.</p> <p>Output X can be forcibly operated via this object (e.g. by a higher-level control). The object value directly defines the forced position of the output:</p> <p>Telegram value: 0 = The output is not forced operated, a forced operation is removed..</p> <p> 1 = The output is forced operated and switched on with the parameterised brightness value. The forced operation is active.</p> <p>The brightness value of the output is calculated with an incoming telegram during forced operation, but is not however displayed. Dimming speeds are not considered with the calculation, i.e. in the background the immediate end values are stored. After the completion of forced operation, the brightness values calculated in the background are set.</p> <p>A dim, scene or preset recall will not be reinitiated.</p> <p>The staircase lighting function continues to operate in the background and after forced operation assumes the state which it would have without forced operation.</p> <p>If the Light Controller had control before forced operation, lighting control will be reassumed after forced operation with the switch on value.</p> <p>After a download the object <i>Forced operation</i> has the value 0. The forced operation is not activated.</p> <p>Forced operation has a higher priority than blocking an output.</p> <p>The state of the bus voltage can be parameterised.</p> <p>For further information see: Parameter window X: Function</p>				

¹⁾ The numbers of the objects apply for outputs A to D.

3.3.3 Per output for function
Preset

Number	Object Function	Name	Length	C	R	V	T	U
17	Call preset 1 and 2	Output A	1 bit	C	-	W	-	-
18	Set preset 1 and 2	Output A	1 bit	C	-	W	-	-
19	Call preset 3 and 4	Output A	1 bit	C	-	W	-	-
20	Set preset 3 and 4	Output A	1 bit	C	-	W	-	-

No.	Function	Object name	Data type	Flags
17, 19 42, 44 67, 69 92, 94 ¹⁾	Call preset 1 and 2 and Call preset 3 and 4	Output A	1 bit (EIS 1) DPT 1.022	C, W
<p>A stored brightness value is accessed with this object. If on this object the value 0 is sent, the parameterised or saved brightness value of Preset 1 or Preset 3 is recalled. Accordingly, the value 1 has the effect that the parameterised brightness value of Preset 2 or Preset 4 is recalled.</p> <p>Telegram value: 0 = Recall preset 1 or preset 3 1 = Recall preset 2 or preset 4</p> <p>The response during slave operation or with an activated staircase lighting function can be found in the parameter windows X: Slave or X: Staircase light.</p>				
18, 20 43, 45 68, 70 93, 95 ¹⁾	Set preset 1 and 2 and Set preset 3 and 4	Output A	1 bit (EIS 1) DPT 1.022	C, W
<p>Using this object it is possible to store the current brightness value as the new preset value. The object value 0 has the effect that the current brightness value is saved as Preset 1 value (or Preset 3 value). The value 1 saves the current brightness value as Preset 2 value (or Preset 4 value).</p> <p>Telegram value: 0 = Set preset 1 or preset 3 1 = Set preset 2 or preset 4</p>				

¹⁾ The numbers of the objects apply for outputs A to D.

3.3.4 Per output for function 8 bit scene

Number	Object Function	Name	Length	C	R	V	T	U
21	8 bit scene	Output A	1 Byte	C	-	W	-	-
22	Restore standard scene	Output A	1 bit	C	-	W	-	-

No.	Function	Object name	Data type	Flags
21, 46, 71, 96¹⁾	8 bit scene	Output X	1 byte Non EIS DPT 18.001	C, W

This object is enabled if in parameter window [X: Function](#) the 8 bit scene function is enabled. Using this 8 bit communication object a scene command can be sent using a coded telegram, which integrates the output of the Light Controller in a KNX scene. The telegram contains the number of the respective scene as well as the information if the scene is to be retrieved, or if the current brightness value is to be assigned to the scene.

Telegram format (1 byte): M0SS SSSS
(MSB) (LSB)

M: 0 = scene is recalled
1 = scene is stored (if allowed)

S: Number of the scene (1...64:
00000000...00111111)

KNX 8 bit telegram value		Meaning
Decimal	Hexadecimal	
00	00h	Recall scene 1
01	01h	Recall scene 2
02	02h	Recall scene 3
...
63	3Fh	Recall scene 64
128	80h	Store scene 1
129	81h	Store scene 2
130	82h	Store scene 3
...
191	AFh	Store scene 64

Other figure values have no effect on the scene function store or recall. The complete list of the 8 bit scene telegram is described in the [code table](#).

An example of an 8 bit scene is described in the section [Application and planning](#).

The response during slave operation or with an activated staircase lighting function can be found in the parameter windows [X: Slave](#) or [X: Staircase light](#).

22, 47, 72, 97 ¹⁾	Restore standard scene	Output X	1 bit (EIS1) DPT 1.015	C, W
------------------------------	------------------------	----------	---------------------------	------

This object is enabled if in parameter window [X: Function](#) the object with the parameter *Restore scene values with standard values* is enabled.

The standard brightness value of an 8 bit-scene are defined in the parameter window [X: Scene \(X\)](#). This values can be modified by the user during operation without ETS.

A telegram with the value 1 which is received via this object resets all scene values to the standard values parameterised in the ETS.

Telegram value: 0 = no reaction
1 = overwrite scene values with standard value

¹⁾ The numbers of the objects apply for outputs A to D.

3.3.5 Per output for function **Block**

Number	Object Function	Name	Length	C	R	V	T	U
23	Block	Output A	1 bit	C	-	W	-	-

No.	Function	Object name	Data type	Flags
23, 48, 73, 98 ¹⁾	Block	Output X	1 bit (EIS1) DPT 1.003	C, W

This object is enabled if in parameter window [X: Function](#) the function *Block* is enabled.

The object is used for blocking an output to prevent unwanted operation. Further incoming telegrams are ignored and not evaluated in the background. The incoming telegrams will only be evaluated after a renewed release of the output. The lighting remains unchanged when a block is removed.

A block during the staircase lighting or control function on the other hand leads to an immediate blocking of the output and freezing of the brightness value. After unblocking, the staircase lighting function continues with dimming (prewarning). If lighting control or slave operation were active before the block they will be re-established.

The Block function has a lower priority than forced operation, refer to the [function chart](#).

After bus voltage recovery or download the blocking is removed and the must be reset if required.

Telegram value: 0 = remove block
 1 = block active

¹⁾ The numbers of the objects apply for outputs A to D.

3.3.6 Per output for function
Light control

Number	Object Function	Name	Length	C	R	V	T	U
24	activate control	Output A	1 bit	C	R	W.	-	-
25	Enable calibration	Output A	1 bit	C	R	W.	T	-
26	Calibration lighting	Output A	1 bit	C	R	W.	-	-
27	Calibration daylight	Output A	1 bit	C	R	W.	-	-
28	Master: Slave brightness value	Output A	1 Byte	C	R	-	T	-
29	Setpoint	Output A	1 Byte	C	R	W.	-	-
30	Actual value	Output A	1 Byte	C	R	W.	-	-
32	Sensor value	Output A	1 Byte	C	R	-	-	-

No.	Function	Object name	Data type	Flags
24, 49, 74, 99 ¹⁾	Activate control	Output X	1 bit (EIS1) DPT 1.003	C, R, W
<p>This object is enabled if in parameter window X: General in the parameter <i>Select additional function</i>, the option <i>Light control</i> is selected.</p> <p>Light control can be activated (telegram with value 1) and deactivated (telegram with value 0) via this object. An activation of light control simultaneously causes this light control to immediately commence control.</p> <p>The status of the light control can not be sent via this object. The status byte (bit 1 additional function, active/inactive light control) is available for the status display. Whether light control controls or is in standby mode, e.g. via an off command to object <i>Switch</i>, is displayed by the object <i>Status function</i>.</p> <p>Telegram value: 0 = light control inactive 1 = light control active</p> <p>With deactivation of the light control, the brightness value initially remains unchanged until a telegram is received which changes the brightness.</p>				
25, 50, 75, 100 ¹⁾	Enable calibration	Output X	1 bit (EIS1) DPT 1.003	C, R, W, T
<p>This object is enabled if in parameter window X: General in the parameter <i>Select additional function</i>, the option <i>Light control</i> is selected.</p> <p>Via this object the objects <i>Calibration daylight</i> or <i>Calibration lighting</i> are released for the receipt of a telegram. i.e., the Light Controller undertakes a calibration of the daylight or artificial lighting if a telegram with the value 1 has been received beforehand on the object <i>Enable calibration</i>. This ensures that calibration is not performed unintentionally.</p> <p>The readiness to receive a telegram for activation of the daylight or artificial lighting calibration remains in effect for 1 hour, if a calibration request has not been received and has taken place beforehand via the objects <i>Calibration lighting</i> or <i>Calibration daylight</i>. At the start of the calibration process the object <i>Enable calibration</i> is again set to 0.</p> <p>Telegram value: 1 = For the objects <i>Calibration daylight</i> and <i>Calibration lighting</i> a readiness to receive a telegram is enabled, i.e., the Light Controller undertakes calibration if via the objects <i>Calibration lighting</i> or <i>Calibration daylight</i> a telegram with the value 1 is received. 0 = Immediately resets the readiness to receive a telegram for the objects <i>Calibration daylight</i> and <i>Calibration lighting</i>, i.e. telegrams to the objects <i>Calibration lighting</i> and <i>Calibration daylight</i> are not carried out.</p>				

¹⁾ The numbers of the objects apply for outputs A to D.

No.	Function	Object name	Data type	Flags
26, 51, 76, 101 ¹⁾	Calibration lighting	Output X	1 bit (EIS1) DPT 1.003	C, R, W
<p>This object is enabled if in parameter window X: General in the parameter <i>Select additional function</i>, the option <i>Light control</i> is selected.</p> <p>Using this object the artificial lighting calibration for output X is triggered. Before a telegram with the value 1 is sent to the object <i>Calibration lighting</i> to trigger the calibration of the artificial lighting, the object must be made ready to receive the telegram. This is undertaken by sending a telegram with the value 1 to the object <i>Enable calibration</i>.</p> <p>Telegram value: 1 = triggering of artificial lighting calibration 0 = no effect</p> <p>The calibration of the artificial lighting takes about 1 minute. When the calibration of the lighting is completed the object value is reset to 0. The value is sent on the bus by setting the T flag. After calibration the light control for the output is activated and controlled.</p> <p>The Light Controller is thought to recognise the artificial lighting levels with lighting calibration. At the same time a characteristic for the lighting is recorded and stored in the Light Controller.</p> <p>The artificial light calibration should be undertaken without the influence of daylight. The lighting should be set so that the brightness value (setpoint) which is required during constant lighting control in the room is set.</p> <p>After a reset or discharge of the Light Controller via the ETS the stored values are not lost. The values are only overwritten after a renewed calibration.</p> <p>The artificial lighting calibration should always be undertaken so that the characteristic curve of the luminaries is known to the Light Controller. In principle a setpoint can be read for the <i>Setpoint</i> object for the Light Controller.</p> <p>The current brightness of the setpoint can be read via the <i>Actual value</i> object. If required it can be read in the Light Controller as a new setpoint via the <i>Setpoint</i> object. In this way the current actual value is overwritten.</p> <p>The sequence of daylight and artificial light calibration is not in any desired order. Calibration with artificial light must be performed before calibration with daylight.</p> <p>For further information see: Detailed description of the artificial lighting calibration</p>				
27, 52, 77, 102 ¹⁾	Calibration daylight	Output X	1 bit (EIS1) DPT 1.003	C, R, W
<p>This object is enabled if in parameter window X: Control automatic daylight calibration is parameterised.</p> <p>Using this object the daylight calibration for output X is triggered. Before a telegram with the value 1 can be received on the object <i>Calibration daylight</i>, the object must be made ready to receive it. This is undertaken by sending a telegram with the value 1 to the object <i>Enable calibration</i>.</p> <p>The daylight calibration is undertaken with natural light. The artificial lighting source is switched off by the lighting. In order to avoid an undershoot of the set brightness setpoint in the controlled state, the brightness for the daylight calibration in the reference range should be about 10 % above the brightness for the daylight calibration.</p> <p>Telegram value: 1 = triggering of daylight calibration 0 = no effect</p> <p>The daylight calibration takes about 10 minutes. When the daylight calibration is completed the object value is reset to 0. The value is sent on the bus by setting the T flag. After calibration the light control for the output is activated and controlled.</p> <p>The daylight calibration is thought to recognise the natural lighting levels with lighting calibration. In this way the Light Controller determines the relationship between artificial lighting and daylight which improves the constant lighting control. The daylight calibration should be performed without the influence of artificial lighting. The setpoint brightness is again to be set on the reference point in the room by the change of shading of the setpoint brightness value. If this is not possible the daylight calibration factor can be assigned via the die ETS. This factor can be optimised by experiment by observing the Light Controller so that the light control is set to the setpoint brightness.</p> <p>For further information see: Detailed description of the daylight calibration</p> <p>The sequence of daylight and artificial light calibration is not in any desired order. Calibration with artificial light must be performed before calibration with daylight.</p>				

¹⁾ The numbers of the objects apply for outputs A to D.

No.	Function	Object name	Data type	Flags
28, 53, 78, 103¹⁾	Master: Brightness value of slave	Output X	1 byte (EIS6) DPT 5.001	C, R, T
<p>This object is enabled if in parameter window X: Control the output of the Light Controller is configured as a master.</p> <p>Via this object the current brightness value of the control is sent on the bus so that further devices (slaves) can be set to the same value.</p> <p>Telegram value: 0 = OFF channel is switched off, slave mode remains active</p> <p> ...</p> <p> 255 = 100 %</p> <p>Via the master/slave function additional luminaries can also be integrated with the Light Controller of the lighting control of the LR/S, e.g. DALI luminaries via an ABB i-bus® DALI Gateway DG/S or other 1-10 V luminaries via the ABB i-bus® Switch/Dim Actuators SD/S. The integration of the ABB i-bus® Universal Dimmer UD/S is also possible. In this way highly flexible and energy efficient KNX lighting systems can be integrated into the intelligent installation systems.</p> <p>With deactivated light control (telegram with the value 0 to the object activate control) the brightness value is still sent by the master via the object <i>Brightness value of slave</i>. In this way the lighting combination (master/slave) is always controlled as a unit even with deactivated light control.</p> <p>The master/slave unit is separated, for example, by deactivation of the slave mode (telegram with the value 0 to object <i>Activate slave mode</i>). If the slave mode is deactivated, the brightness values received from the slave via the object <i>Master: Brightness value of slave</i> are not switched to its output.</p>				
29, 54, 79, 104¹⁾	Setpoint	Output X	1 byte (EIS6) DPT 5.001	C, R, W
<p>This object is enabled if in parameter window X: General <i>Select additional function</i> is enabled with the option <i>Light control</i>.</p> <p>Via this object the current setpoint can be read which is on the output (Light control).</p> <p>Also, the setpoint of the light control can be modified via the bus using this object so that different setpoints can be set for the light control, e.g. for competition and training settings in sports centres.</p> <p>It is inadvisable to transfer setpoint values from other rooms as it is practically excluded that both rooms have exactly the same reflection properties and brightness relationships. Furthermore, the characteristic which controls the lighting is determined during the automatic artificial lighting calibration. There are also slight differences from room to room because of manufacturing tolerances. If a setpoint value should still be transferred regardless of these facts, it must be assumed that the light control will be inexact (large setpoint deviations).</p> <p>Telegram value: 0 = OFF</p> <p> ...</p> <p> 255 = 100 %</p> <p>A second setpoint which can be read via the bus, for example, during ongoing operation via a visualisation or a pushbutton, can be determined beforehand via a purely artificial lighting setting and read via the object <i>Actual value</i>.</p> <p>For further information see: Constant lighting control properties</p> <div style="border: 1px solid black; padding: 5px; margin-top: 10px;"> <p>Note</p> <p>This object can be read and written in the ETS. It will not be sent on the bus independent of the T flag.</p> </div>				

¹⁾ The numbers of the objects apply for outputs A to D.

No.	Function	Object name	Data type	Flags
30, 55... 80, 105	Actual value	Output X	1 byte (EIS6) DPT 5.001	C, R, W
<p>This object is enabled if in parameter window X: General in the parameter <i>Select additional function</i> the option <i>Light control</i> is selected.</p> <p>This object contains the current actual value of the light control (see diagram control circuit). The actual value results from one or more sensors. It can be the lowest, the largest or the average value of the sensor value. This is parameterised in the parameter window Light sensor.</p> <p>If the output is only assigned to a Light Sensor, the actual value is equal to the sensor value. With several sensors the calculated sensor value is used for the light control.</p> <p>Telegram value: 0 = OFF ... 255 = 100 %</p> <p>The actual value is equal to the setpoint value in a perfectly balanced control circuit. Thus it is possible to read the value (setpoint) which results with a desired brightness via the actual value object. This read value can be used in ongoing operation in order to provide a new setpoint to the output of the Light Controller on the bus via the <i>Setpoint</i> object.</p> <p>For further information see: Constant lighting control properties</p> <div style="border: 1px solid black; padding: 5px; margin: 10px 0;"> <p>Note</p> <p>This object can be read and written in the ETS. It will not be sent on the bus independent of the T flag.</p> </div>				
31, 56, 81, 106	Free	not assigned		
32, 57, 82, 107¹⁾	Sensor value	Output X	1 byte (EIS6) DPT 5.001	C, R
<p>This object is always enabled. Using this the Light Sensor can also be monitored if the sensor is assigned to another output.</p> <p>This object contains the measured values which are currently measured by the Light Sensor. The sensor value always relates to the Light Sensor which is connected to Input X. This is also the case when the Light Sensor is assigned to another output. The sensor value can be sent on the bus via a read request. In this way a direct change in the brightness on the sensor can be visualised.</p> <p>The read value is an unsigned value which complies with the measured value of the sensor. It does not comply with a direct light value, e.g. the lighting intensity or the light density.</p> <p>The object <i>Sensor value</i> is primarily intended for analysis purposes in order to detect if the Light Sensor brightness values are detected and correctly connected to the Light Controller.</p> <div style="border: 1px solid black; padding: 5px; margin: 10px 0;"> <p>Note</p> <p>The Light Sensor features a photocell which supplies a current dependent on the brightness level. This current is evaluated by the Light Controller. No current will flow for the Light Controller in the event of a break in the sensor cable, short circuit or reverse polarity. In all three cases the minimum brightness is produced at a sensor value of 0.</p> </div> <p>It is prudent to set the T flag during the commissioning phase. In this way the sensor value is sent on the bus for analysis purposes should it change. During normal operation it is advisable to remove the T flag to prevent unnecessary bus loads.</p>				
33,58, 83,108	Free	not assigned		

¹⁾ The numbers of the objects apply for outputs A to D.

3.3.7 Per output for function
Slave mode

Number	Object Function	Name	Length	C	R	V	T	U
24	Activate slave mode	Output A	1 bit	C	-	W	-	-
25	Brightness value of slave	Output A	1 Byte	C	-	W	T	-

No.	Function	Object name	Data type	Flags
24, 49, 74, 99 ¹	Activate slave mode	Output X	1 bit (EIS1) DPT 1.003	C, W
<p>This object is enabled if in the parameter window X: General the additional function <i>Slave mode in lighting control</i> has been enabled and simultaneously in parameter window X: Slave the parameter <i>Slave is controlled via</i> with the option <i>External via object</i> is set.</p> <p>The object serves for activation / deactivation of the slave mode. With deactivation the device behaves like a “normal” Light Controller without slave function. The slave mode can be reactivated if a telegram with the value 1 is received via this object.</p> <p>By setting the T flag the object is actively sent after bus voltage recovery.</p> <p>Telegram value: 0 = slave mode not activated 1 = activate slave mode</p>				
25, 50, 75, 100 ¹	Brightness value of slave	Output X	1 byte (EIS6) DPT 5.001	C, W, T
<p>This object is enabled if in parameter window X: General the additional function <i>Slave mode in lighting control</i> is enabled.</p> <p>The slave output receives the brightness value via this object, e.g. from a higher level Light Controller which is parameterised as the master.</p> <p>If the mode is deactivated or slave mode is latent, after an Off command 0 to the object <i>Switch</i> or <i>Switch / Status</i>, the telegrams to the object <i>Slave brightness value</i> have no effect. In the parameter window X: Slave you can parameterise if a dim, set value, scene or preset command interrupts the slave mode.</p> <p>Brightness values which are above or below the predefined max. or min. brightness values are not set. In this case the value limits are set.</p> <p>Telegram value: 0 = OFF output is switched off, slave mode remains Active. ... 255 = 100 %</p>				

¹⁾ The numbers of the objects apply for outputs A to D.

3.3.8 Per output for function
Staircase light

Number	Object Function	Name	Length	C	R	V	T	U
24	Activate staircase function	Output A	1 bit	C	-	W	-	-
25	Permanent ON	Output A	1 bit	C	-	W	-	-
26	Duration of staircase lighting	Output A	2 Byte	C	R	W	-	-
27	Warning staircase lighting	Output A	1 bit	C	-	-	T	-

No.	Function	Object name	Data type	Flags
24, 49, 74, 99 ¹⁾	Activate staircase function	Output X	1 bit (EIS1) DPT 1.003	C, W
<p>This object is enabled if in parameter window X: General in parameter additional function <i>Staircase light</i> is enabled.</p> <p>The <i>Staircase lighting</i> function can be activated or deactivated via this object. With a deactivated staircase lighting function the output of the device behaves like a “normal” output of a Switch / Dim actuator. The staircase lighting function is again activated if the value 1 is received via the object described here.</p> <p>If the staircase lighting is switched off at the time when it is activated, the base brightness is set. If the lighting is switched on at the time, the staircase light brightness is set and the staircase light time times out.</p> <p>After bus voltage recovery the staircase lighting function is always activated. By setting the T flag the object is actively sent after bus voltage recovery.</p> <p>Telegram value: 0 = staircase lighting function not activated 1 = activate staircase lighting function</p>				
25, 50, 75, 100 ¹⁾	Permanent ON	Output X	1 bit (EIS1) DPT 1.001	C, W
<p>This object is enabled if in parameter window X: General in parameter additional function <i>Staircase light</i> is enabled.</p> <p>Serves as an active staircase light control for permanent switch on of the lighting (also called “Service light”).</p> <p>After a bus voltage recovery or download the object value is set to 0 and a permanent on is not active.</p> <p>Telegram value: 0 = Permanent ON not active 1 = Permanent ON active</p>				
26, 51, 76, 101 ¹⁾	Duration of staircase lighting	Output X	2 byte (EIS 10) DPT 7.005	C, R, W
<p>This object is enabled if in parameter window X: General in parameter additional function <i>Staircase light</i> is enabled.</p> <p>Via this object the staircase lighting time can be set via the KNX. The time (counter value) is defined in seconds. After bus voltage recovery the object value is accepted by the programmed value in the ETS and the value set via the bus is lost.</p>				
27, 52, 77, 102 ¹⁾	Warning staircase lighting	Output X	1 bit (EIS 1) DPT 1.005	C, T
<p>This object is enabled if in parameter window X: General in parameter additional function <i>Staircase light</i> is enabled.</p> <p>The value of the object is used to provide a warning before the staircase lighting time times out. The object has the value 1 during the warning.</p> <p>If a forced operation is activated during the prewarning, the prewarning is reset and a 0 is written into the object <i>Warning staircase lighting</i> and a telegram with the value 0 is sent on the KNX.</p>				

¹⁾ The numbers of the objects apply for outputs A to D.

3.3.9 Per output for the Diagnostics

Number	Object Function	Name	Length	C	R	V	T	U
3	Status function	General	1 Byte	C	R	-	T	-
34	Status byte	Output A	1 Byte	C	R	-	T	-

No.	Function	Object name	Data type	Flags
3	Status function	General	1 byte Non EIS Non DPT	C, R, T

This object is always visible so that the state of the additional functions (*Light control, Staircase light* and *Slave mode*) can always be queried, see [Status function table](#).

The status refers to the state of the additional functions, i.e. is the staircase lighting time running, is the light controller running or does the slave receive a brightness value via the object *Brightness value of slave*.

The state does not initially have anything to do with the activation of the additional functions by the object *Activate xy* (*xy* = light control, slave mode for light control or staircase lighting time). This state is indicated in the first bit of the status byte object (No. 34, 59, 84, 109).

A prerequisite for this is that an output does not change its state (operates, controls): The additional function must be activated.

Every bit defines the state of an output. The first bit belongs to output A, the second bit to output B. For the four-fold Light Controller the third and fourth bits define the states of outputs C and D:

Telegram value: 0 = additional function latent, it is in standby mode and is not undertaken or it is fully deactivated.

 1 = light control controls, staircase light runs, slave mode operates. Extra function is active.

For further information see: [Code table](#)

Note

If forced operation is activated when an additional function is operational, e.g. Permanent ON with staircase light, this forced operation is carried out. The "normal" operation continues to run in the background so that the output reassumes its previous function immediately after switch off of the forced operation. For this reason the respective function of the object *Status function* remains 1 (running). Only when the additional function has really been completed is it possible to set the respective bit in the object *Status function* to 0 (not running).

The information regarding if the additional function is actually active can be queried via the first bit of the status byte of the output, or directly via the respective object *Activate xy* (*xy* = light control, slave mode for light control or staircase lighting time). If the additional function is deactivated (by sending of a 0 to the object *activate xy*), the respective bit of the object *Status function* is automatically 0.

34, 59, 84, 109 ¹⁾	Status byte	Output X	1 byte Non EIS Non DPT	C, R, T
<p>This object is always visible so that the status of the Light Controller is always available. This object is useful particularly if the device does not function as required. It indicates the possible causes:</p> <p>Telegram value: Bit 0 = additional functions (Light control, staircase light or slave mode) is active 1 or inactive 0 Bit 1 = Block function is active 1 or inactive 0 Bit 2 = Forced operation is active 1 or inactive 0</p> <p>Bits not used can be defined with the value 0.</p> <p>A detailed assignment of the object value for the status byte is listed in the Annex. The object value is sent with a change, download and reset.</p> <p>Bit 0 always has the value 1 (active), if one of the three additional functions, Light control, Staircase light function of slave mode is activated. The three additional functions can not be enabled simultaneously for an output of the Light Controller. Bit 0 then has the value 1 if the slave and control modes are in standby mode after an OFF command.</p> <div data-bbox="683 891 1442 1032" style="border: 1px solid black; padding: 5px; margin: 10px 0;"> <p>Note</p> <p>The state of the additional function (staircase light operates, Light Controller controls or the slave does not contain a brightness value from the master) is indicated in the object Status function (No. 3).</p> </div>				

¹⁾ The numbers of the objects apply for outputs A to D.

4 Planning and application

In this section you will find some tips and application examples for practical use of the Light Controller.

4.1 Number of connectable ballasts

Several electronic ballasts with a 1-10 V interface can be controlled by a single output of the Light Controller. The number of dimmable ballasts per output is limited both by the switching and the control powers of the Light Controller.

Both sizes determine the maximum number of connectable 1-10 V ballasts.

The smaller number of ballasts limits the maximum number of ballasts which can be connected to an output.

Example

The 1-10 V control current of the Light Controller allows up to 50 ballasts on the Light Controller output.

Only 25 ballasts are allowed due to the technical properties of the switch relay in the Light Controller output and the inrush current of the ballasts.

Thus only 25 ballasts can be connected to the output of the Light Controller.

In this case the number of ballasts can only be increased when the load current of the ballast is not switched via the relay in the Light Controller, but rather by an external contactor. Only the control current of the contactor coils is switched via the relay of the Light Controller. In this case the load capacity of the contactor contact and not the load capacity of the relay in the Light Controller is required for the calculation of the maximum number of ballasts.

Each output should be considered individually. A mutual influence between the outputs must not be considered.

4.1.1 Load current influence

The electronic ballast is a device for operating gas discharge lamps, e.g. fluorescent lamps. During normal operation the electronic ballast converts the mains voltage to an optimum operating voltage for the gas discharge lamps.

With the original choke/starter circuitry the lamps switched on consecutively, with the electronic ballast all fluorescent lamps switch on practically simultaneously. If switch on occurs at the mains voltage peak, the buffer capacitor of the electronic ballast cause a high but very short current pulse. With the use of several ballasts on the same circuit, the simultaneous charging of the capacitors may result in very large system switch on currents (inrush current peaks I_p) flowing.

This peak inrush current I_p is to be considered when designing the switch contacts as well as by the selection of the respective circuit protection. In the following the effects of the electronic ballast peak inrush current and the associated limitation of the number of electronic ballasts in the Switch/Dim Actuators are examined.

The inrush current of the electronic ballast depends not only on the power consumption but also on the type, the number of elements (lamps) and on the manufacturer. For this reason the given maximum number of connectible electronic ballasts per output can only relate to a defined type of electronic ballast. For a different type this value can only represent an estimation.

In order to properly estimate the number of electronic ballasts, the peak inrush current I_p with the respective pulse width of the electronic ballast must be known.

In the meantime, these values are stated by the manufacturer in the technical data or are available on request.

Typical values for single element electronic ballasts with T5/T8 lamps are:

Peak inrush current 15 A to 50 A with a pulse time of 120 μ s to 200 μ s.

Every relay in the output of the Light Controller features the following maximum switch on values:

	LR/S x.16.1
Maximum peak inrush-current I_p (150 μ s)	400 A
Maximum peak inrush-current I_p (250 μ s)	320 A
Maximum peak inrush-current I_p (600 μ s)	200 A

If these limit values are exceeded the relay will be destroyed, e.g. it will weld.

Example

ABB EVG 1 x 58 CF:

Peak inrush current $I_p = 33.9$ A (147.1 μ s)

For the LR/S 4.16.1 Light Controller this means:

Maximum number of electronic ballast per output = 400 A / 34 A = 11 electronic ballasts

4.1.2 Control current influence

The 1-10 V interface operates according to the current source principle. Hereby, the ballast is a current source which generates a constant current. The Light Controller (current sink) represents an electrical end stage, so that the voltage value corresponds to the required dimming setting. The output stage of the Light Controller output has been designed so that it can counteract a maximum control current of 100 mA and generate a control voltage of 1 V on the ballast. At a 1 V value the minimum brightness which the ballast can set results.

If the number of ballasts produces a current greater than 100 mA, the Light Controller output is no longer in a position to reduce the voltage on the ballast to 1 V. In this case the minimum dimming value of the ballast can not be set.

The same problems can occur if the control line is too long or if its cross-section is too small. In these cases the resistance and accordingly the voltage drop on the line is too large, so that the actual control voltage on the ballast does not correspond to the required voltage value.

The control current generated by the ballast depends on the type and manufacturer of the ballast. Typical currents are between 0.4 and 4 mA. If an average control current of 2 mA is assumed, 50 ballasts can be connected to a Light Controller output.

With a cable cross-section of 0.8 mm² a simple control line length of 70 m is possible from the Light Controller to the ballast, or at a cross-section 1.5 mm² 100 m is possible from the ballast to the Light Controller.

An open control line causes a voltage drop of 10 V on the ballast and affects the maximum brightness of 100 %.

A short-circuited control line allows the voltage to collapse and the minimum dimming value of the control device is set.

The polarity must be observed when the control line is connected. If the polarity is reversed, the ballast can not be dimmed and the minimum dimming value is set.

4.2 Function chart

The following illustration indicates the sequence in which the functions of the Light Controller operating mode are processed. Objects, which lead to the same box have the same priority and are processed in the sequence in which the telegrams are received.

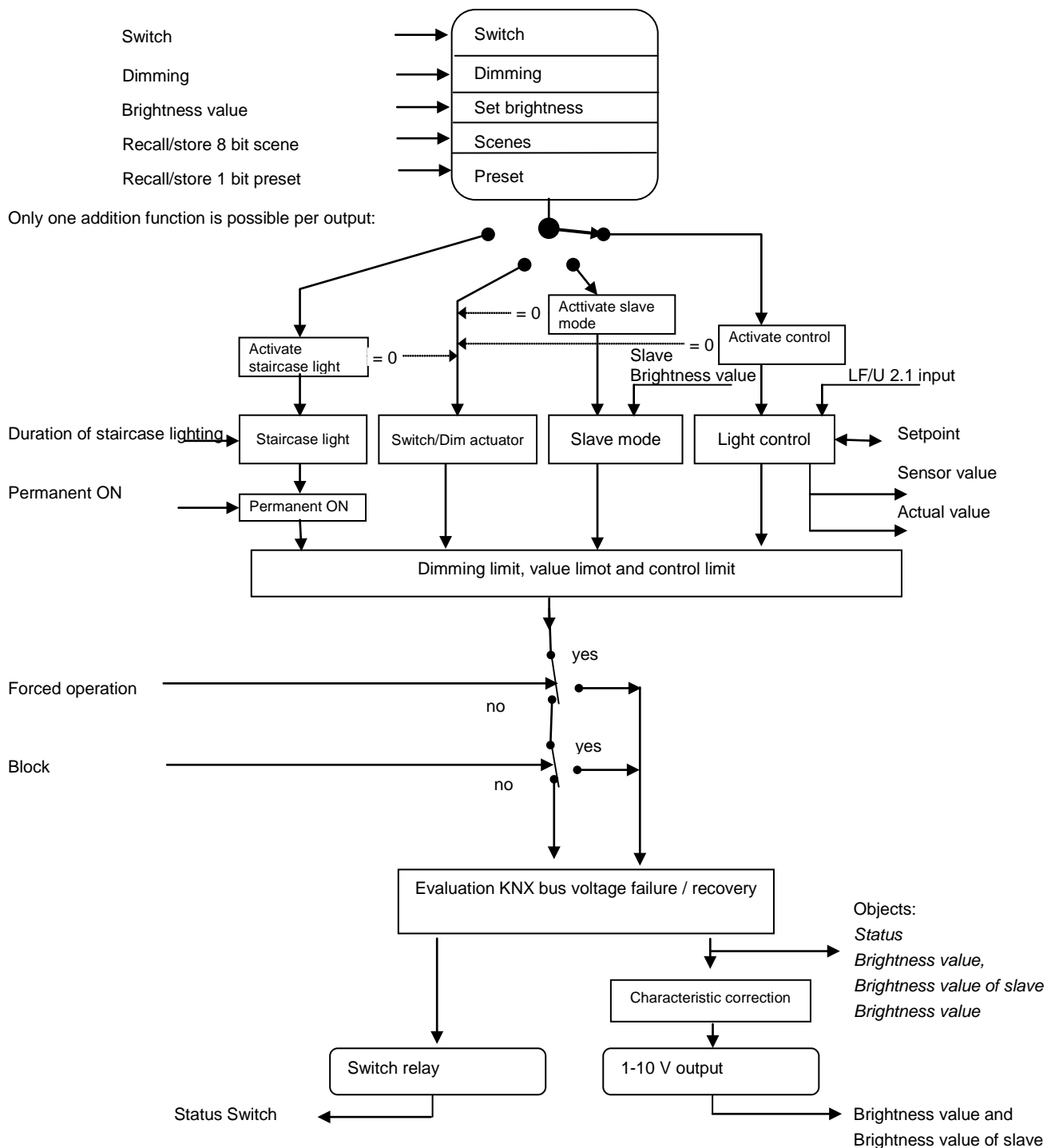

4.3 Staircase lighting time

With the active staircase light function the other additional functions of the device are deactivated, with the exception of forced operation and block function.

When the telegram value 1 is received on the object *Switch*, the lighting is switched on. After the staircase lighting time T_{ON} (parameter time duration in s [0...65,535]) has elapsed, the lighting dims in an adjustable dimming time T_D to a defined brightness value ("Base brightness"). If this value is zero, the lighting switches off after the minimum dimming value is reached. The parameterised dimming limit values defined in the parameter window [X: Dimming](#) apply.

During an activated staircase lighting function the preset and scene commands have no effect.

After bus voltage recovery the staircase lighting function is activated. The lighting state remains unchanged: If the lighting was switched on, the switch on brightness value is set and the lighting is restarted. If the lighting was switched off, the brightness value switches to the basis brightness.

The dimming time T_D relates to the minimum dimming value or the basis brightness, depending on the value that is reached first. Using this logic the light is always dimmed for the entire prewarn time T_D , in order to provide a sufficiently long warning before the staircase light is switched off.

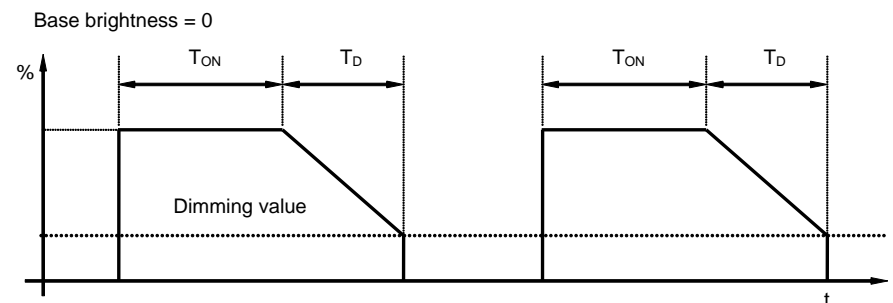

Brightness behaviour with basis brightness = 0

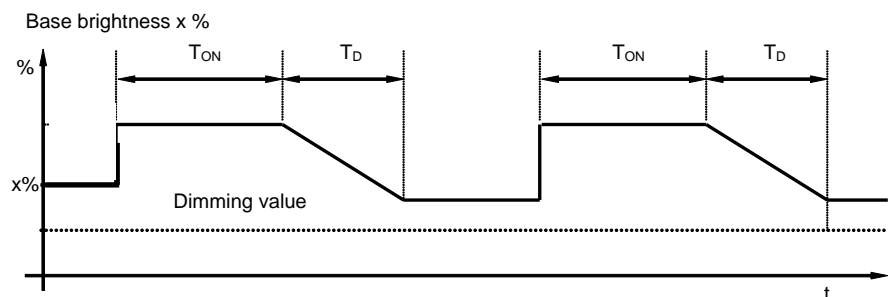

Brightness behaviour with a basis brightness not equal to 0

T_{ON} = duration of the staircase lighting function

T_D = dimming time (prewarning)

A telegram with the value 0 which is received by the object *Activate staircase* function deactivates the staircase function. Thereafter, the device operates like a “normal” switch/dimming actuator, i.e. all other functions such as relative dimming, setting of a brightness value and the scene and preset functions can be fully used again.

For renewed activation of the staircase light function a telegram with the value 1 must be received on the object.

With switched on staircase lighting the maximum and minimum dimming values, as defined in parameter window [X: Dimming](#) must be defined. The respective parameterized values are set with overshoot or undershoot.

Option: yes (retriggerable):

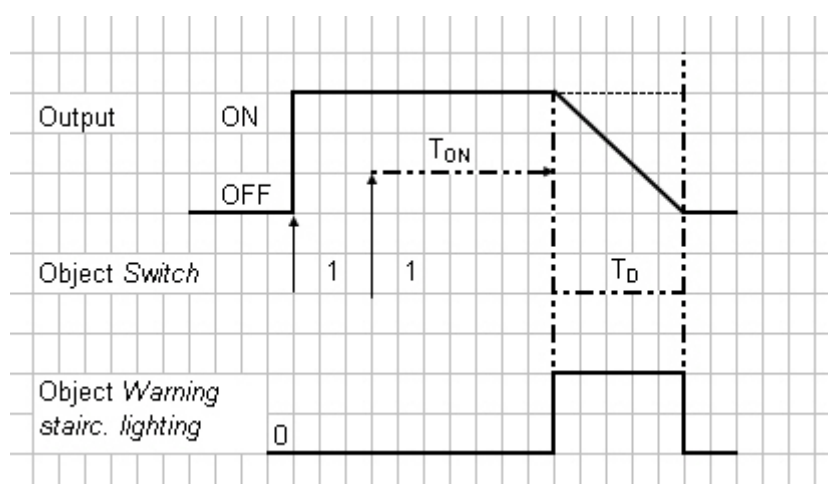

Diagram staircase lighting time T_{ON} = duration of the staircase lighting function
 T_D = dimming time (prewarning)

After the staircase lighting time T_{ON} has timed out the output switches off automatically. With each telegram 1 the time restarts (“retrigger function”), if the parameter *Extending staircase lighting by multiple operation (pumping up)* is set to *yes* in the parameter window [X: Staircase light](#) is set to *yes* (retriggerable)

In this example, a dimming with the corresponding prewarning is parameterised. The “1” warning is visualised by the dimming. At the same time, the object *Warning staircase lighting* can be switched as a project-specific warning (e.g. optical or acoustic warning).

With pumping, the user can adapt the staircase lighting time to the current requirements by pressing the pushbutton several times in succession. The maximum duration of the staircase lighting time can be set in the parameters.

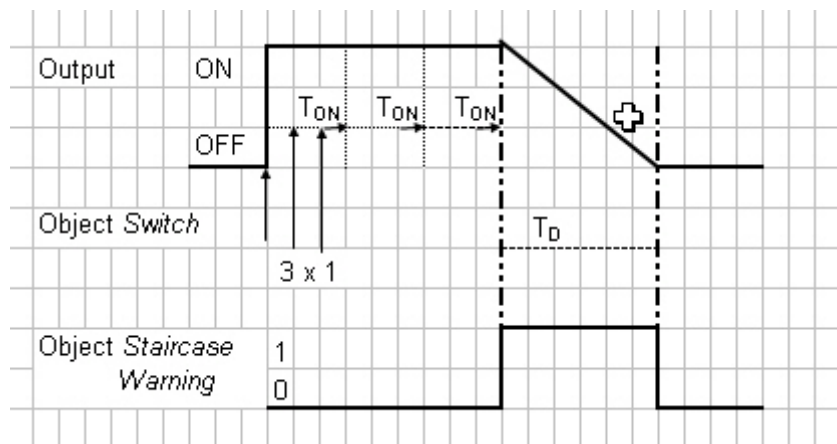

Diagram Staircase lighting time – pumping up T_{ON} = duration of the staircase lighting function
 T_D = dimming time (prewarning)

If the device receives a further ON command during the staircase lighting time T_{ON} , the staircase lighting time is added to the remaining period. Dimming T_D (warning time) is not changed by "pumping up" and is added to the extended (x times T_{ON}) staircase lighting time.

4.4 Preset description

A parameterisable switching state can be retrieved with the help of presets. Light scenes can therefore be implemented for example by a 1 bit object.

Retrieve preset

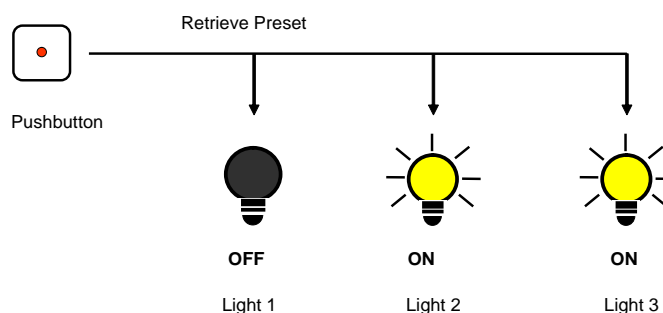

Switch states (preset values) can be retrieved via the object *Call preset 1 and 2*. A maximum of 4 preset values are available for each output:

Action	Telegram
Recall preset 1	Object <i>Call preset 1 and 2</i> = 0
Recall preset 2	Object <i>Call preset 1 and 2</i> = 1

Store preset

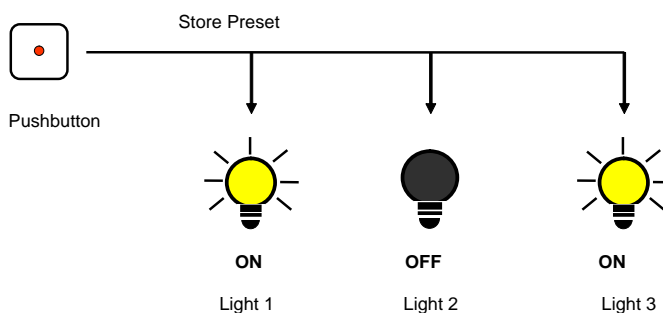

The current switching state is stored as a new preset value via the object *Set preset 1 and 2*. The user can for example adapt a light scene in this way. The presets are stored via the following values:

Action	Telegram
Save preset 1	Object <i>Set Preset 1 and 2</i> = 0
Save preset 2	Object <i>Set Preset 1 and 2</i> = 1

A similar behaviour applies for preset 3 and 4 with the objects *Set preset 3 and 4* and *Recall preset 3 and 4*

Special function: Restore state

A useful special function can be assigned to Preset 1. It is thus possible to recreate the brightness level (states) which were present before retrieving the first preset recall. The recall can be implemented via Preset 2, 3 or 4. The following diagram clarifies this:

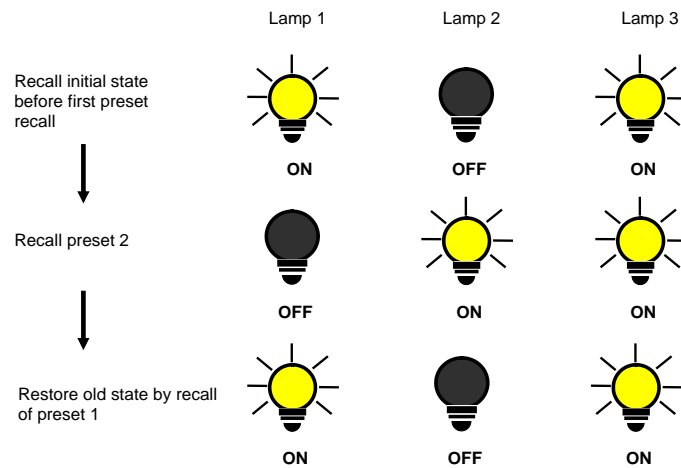

This function can be used for example after a presentation to restore the lighting to the state it was in beforehand.

With the first recall of a preset the current state of the output is stored. If a preset was already active the saved state will not be overwritten. This ensures that the state before the first preset recall can be re-established. If the preset is recalled more often, the state of the first recall applies.

After the command *restore value before first preset call* has been recalled, the current state will be stored with the next preset recall in order to recall it again at a later time.

A similar behaviour applies for preset 3 and 4 with the objects *Set preset 3 and 4* and *Recall preset 3 and 4*

4.5 8 bit scene

With the 8 bit scene, e.g. a pushbutton or a visualisation with an 8 bit telegram, the system receives an instruction to set/recall a scene. The information (brightness value and transition time) is not stored in the pushbutton, but rather in the Light Controller and the other ABB i-bus® devices in the system. All scene devices, such as an output of the Light Controller, are addressed by the same group address. It is sufficient to send a single telegram to recall the scene with all outputs involved.

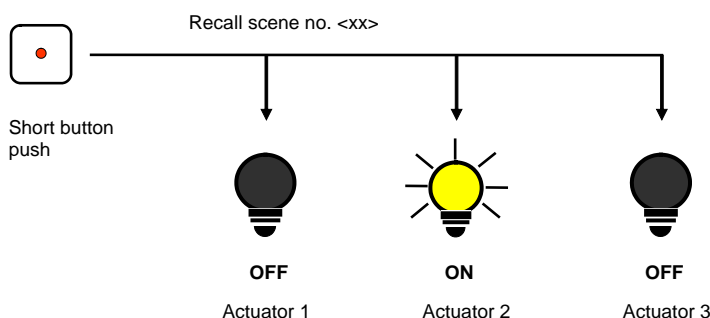

In the 8 bit telegram value, the scene number which must match the scene number in the parameters of the Light Controller is included.

Up to 64 different scenes can be managed via a single KNX group address. An 8 bit scene telegram ([code table](#)) contains the following information.

- Number of the scene (1...64)
- Retrieve scene/store scene

In the following the 8 bit scene the function is described which controls multiple KNX devices.

With the 8 bit scene it is possible to retrieve one of 64 scenes or to connect multiple KNX devices in an 8 bit scene, e.g. shutter, switch actuator and DALI gateways or Dim actuators. The scene can be retrieved or stored using a single 8 bit telegram.

The precondition is that all operating devices or outputs of a device are parameterised with the same scene number.

Each KNX device involved receives the 8 bit scene telegram and independently controls the scenes values. For example, the outputs are switched on or off via the Dim actuator, the shutters actuator moves the shutters to a defined position or the DALI gateway dims its output to the pre-programmed brightness values.

Up to 64 different scenes can be managed via a single KNX group address. An 8 bit scene telegram ([code table](#)) contains the following information.

- Number of the scene (1...64)
- Retrieve scene/store scene

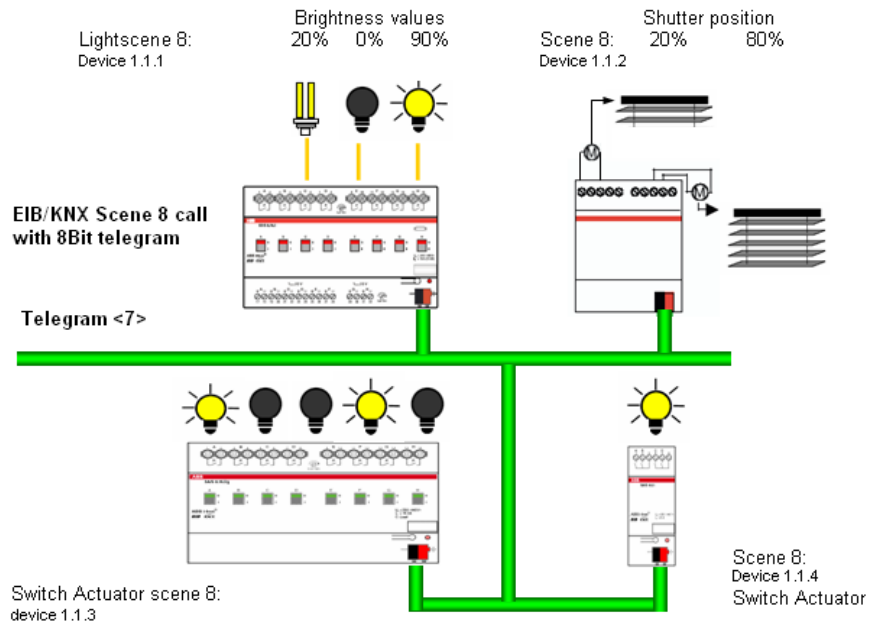

Example

A KNX 8 bit scene (No. 8) comprises of some lamps, which are connected to two Switch Actuators and a Light Controller output. Furthermore, two shutters are integrated into the scene via a shutter actuator. The scene can be retrieved via a single KNX telegram. The prerequisite for this is that all devices have programmed scene 8 accordingly in the devices. After a telegram has been received, the slave switches on its scene number 8. The shutter actuator moves the shutters to the corresponding position, the lighting assumes the predefined brightness values and switching states defined by the scene.

Benefit

The 8 bit scene offers some advantages compared to conventional scene programming via several KNX groups. On the one hand only a single telegram which is received by all participants in the scene and implemented accordingly, is sent on the bus to retrieve a scene. On the other hand, the target positions of the shutter, the contact position of the Switch Actuator outputs and the brightness value of the Light Controller are stored in the participating devices and do not need to be sent via the KNX each time they are to be retrieved.

Note

The scene numbering 1 to 64 is retrieved via the KNX with a telegram number 0 to 63. Refer to the [code table](#) for the corresponding scene coding.

4.6 Characteristic adjustment

Sometimes it is necessary to adjust the dimming characteristic of lighting to the sensitivity of the human eye. This can be undertaken with a characteristic adjustment. Normally the object value 0...255 is assigned with the proportional brightness value 0 %...100 % (see normal characteristic in the illustration). This curve can be converted by four value pairs to an adjusted curve. A linear interpolation of the characteristic is undertaken between the value pairs.

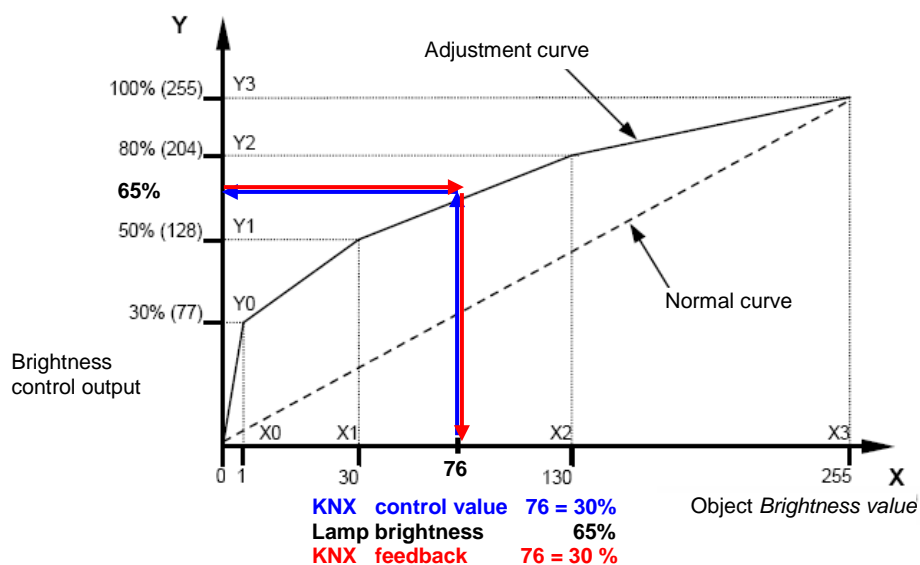

If the lights should be brighter in the lower range, the brightness value of object value 1 can be increased or reduced. In the upper example (see figure) in the first value pair the brightness for value 1 has therefore been defined at 30 %. The other value pairs in the example have been defined so that they result in a curve that has a flatter progression in the upper range. With relative dimming a flatter dimming ramp is thus achieved.

In extreme cases the brightness characteristic can even be inverted.

$$X = 1 \rightarrow Y = 255 \text{ (100 \%)} \text{ and } X = 255 \rightarrow Y = 1 \text{ (0.3 \%)}$$

In this case, the maximum control value 255 sets the minimum brightness value of 0.3 % and the minimum control value 1 sets the maximum brightness value of 100 %.

The feedback brightness values received via object *Status brightness value* or *Brightness value/Status* also take the curve into consideration, i.e. a control variable of 76 (30 %) is transformed to a brightness value of 65 % to control the lighting. The lighting feeds back 65 %. This value is transformed once again to 76 (30 %) and provided as a brightness value in the KNX. In this way, a constant lighting control of a Lighting Controller is possible to operate without difficulties, as the control value and the feedback directly correspond and a correct control factor can be calculated.

Note

The value, dimming and brightness values are used before the transformation. Through the transformation a setting signal may result for the lamps which is less than or greater than the maximum or minimum brightness values.

4.6.1 Differing light strips

With this characteristic correction a second light strip (slave) can be controlled with a brightness difference to the master lighting strip. This is a way to set the rear lighting strip in the room to an amount x brighter than the lighting strip which is located near the windows. In this way energy can be saved in rooms with sufficient daylight.

If you wish to use this behaviour in a constant lighting control, the characteristic correction has to be determined in a slave output. The master output should be the brighter lighting strip which is further away from the window.

The following example is based on a room as schematically represented in the following illustration. The lighting strip (1) furthest away from the window should always be controlled by the **value 20 (8 %)** brighter than the lighting strip (2) beside the window. A constant lighting control should still be implemented in the room. The brightness is detected with a Light Sensor (3).

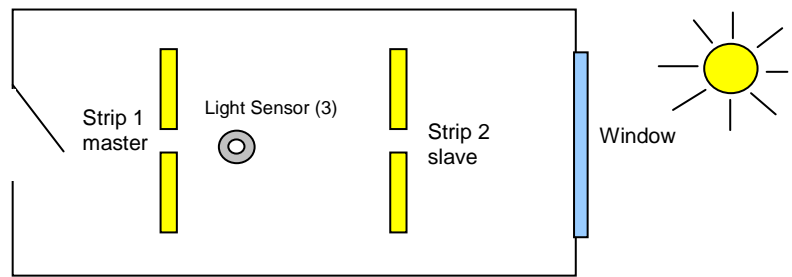

Schematic representation of an office area

The Light Sensor is located in the rear third of the room and when possible should be installed under the workstation being monitored but should not be subject to or affected by a direct source of light or reflections.

Case 1: The master is the brighter lighting strip

Strip 1 is connected to output A of the Light Controller and is parameterised as a master. Strip 2 is controlled via output B of the Light Controller and is parameterised as a slave with the following characteristic correction (darker minus 20 digits):

In the parameter window [X: Charact. adj.](#) the *Number of value pairs* is set to 4 and entered for the above mentioned offset of the following values:

$$X0 = 1/Y0 = 1, X1 = 20/Y1 = 1, X2 = 254/Y2 = 235, X3 = 255/Y3 = 255$$

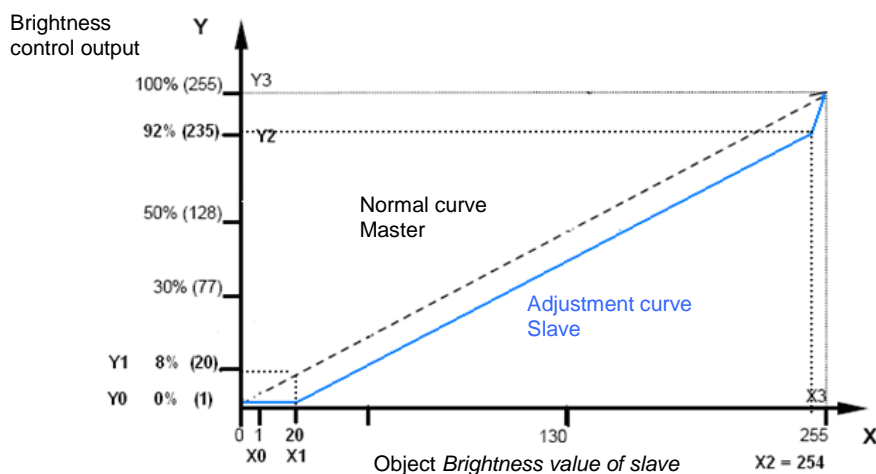

This has the following effect: As soon as the master (brighter strip 1 at the rear of the room) is switched on, the slave will also receive an ON command, however with the minimum brightness. This has the advantage that the user immediately recognises that they are controlling both light strips. As soon as the master has achieved the brightness value 8 % (20 digits), the slave is controlled as 20 digits darker than the master. This continues until the master achieves the brightness value (254). As there is no higher value than 255 the slave is also controlled with 254 at this point. This ensures that the maximum possible brightness level is achieved in the room.

Case 2: The master is the darker lighting strip

If the darker lighting strip (2) is the master, this will result in the following characteristic correction.

In the parameter window [X: Charact. adj.](#) the *Number of value pairs* is set to 3 and the following values are entered:

$$X0 = 1/Y0 = 20, X1 = 235/Y1 = 254, X2 = 255/Y2 = 255$$

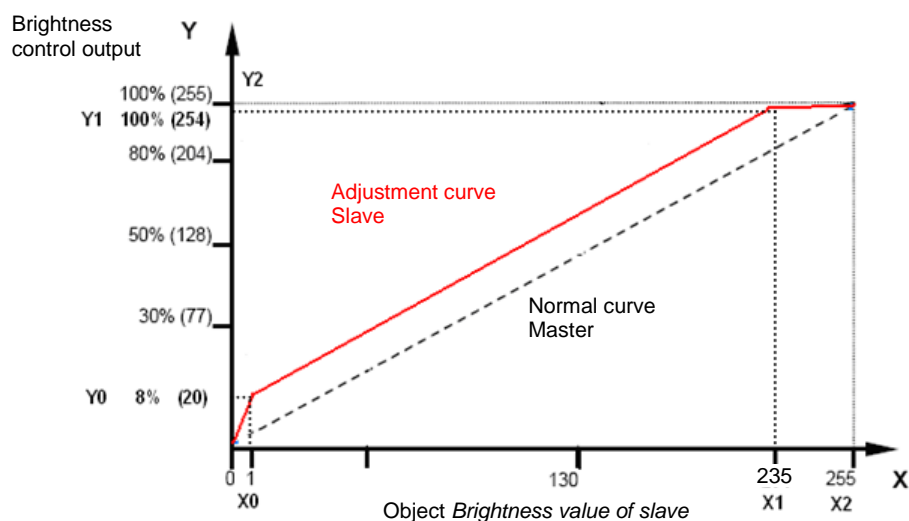

This has the following effect: Only when the darker lighting strip 2 (which is nearer the window) switches on is the brighter strip 1 (located at the back of the dark room) switched on. Up to this point in time it may be possible that the rear area of the room is too dark. In order to avoid this, the brighter strip 1 should be controlled. Thus at the rear area of the room there can be sufficient brightness if the master (the darker strip) is not yet switched on.

Note

The characteristic adjustment acts directly on the 1-10 V output and not on the object *Master: Slave brightness value* or *Brightness value of slave*. This means that a characteristic adjustment must be set in the output of the Light Controller or in the external slave.

In a master/slave combination of LR/S x.16.1 and DG/S 1.1 or DG/S 8.1 a characteristic adjustment may not be transferred to the DG/S.

4.7 Constant lighting control

Constant lighting control is possible with the Light Controller LR/S x.16.1 in conjunction with the Light Sensor LFU 2.1. The following illustration indicates the principle function of constant light control.

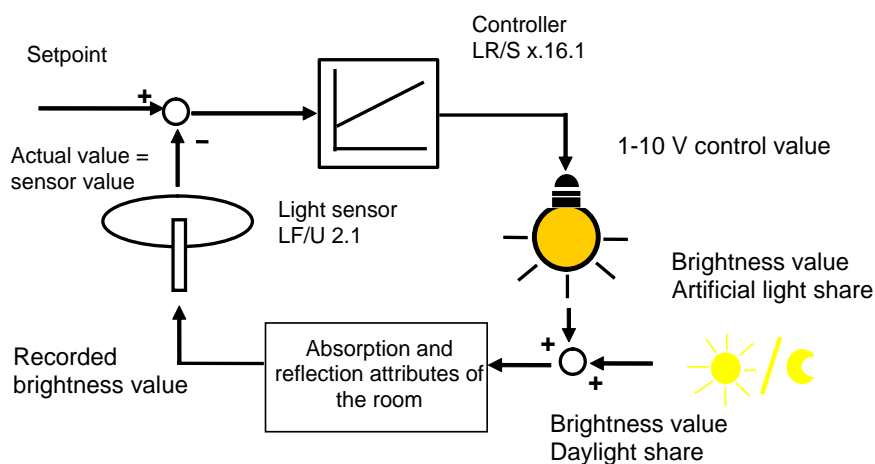

Principle representation of constant lighting control

With constant light control this is a so-called fixed (or constant) value control or interference variable control. The interference variable in our case is the incidence of daylight. The setpoint is the brightness value which should be set automatically in the room. The setpoint is stored during the commissioning in the Light Controller with the calibration of the artificial lighting or daylight or is read via the object *Setpoint* in the Light Controller. The technical lighting properties of the room and the characteristic of the luminaries are automatically determined during the artificial lighting calibration by the Light Controller LR/S x.16.1. This parameter uses the Light Controller for determination of the controlled system. The Light Controller sets the brightness (luminaries) so that the control divergence between the setpoint and the actual value is equal to 0.

The Light Controller sets constant room brightness levels by the addition or removal of artificial lighting. This constant room brightness is often selected so that sufficient lighting is available for an optimum working environment.

The following DIN EN 12464-1 compliant brightness levels must be observed for special working conditions:

- Self-service restaurants 200 lx
- Open-plan offices 500 lx
- Assembly of precision devices, e.g. radio and television sets 750 lx

In ideal cases the daylight is sufficient to ensure optimum brightness levels at the place of work. In this case the artificial light is completely switched off by the Light Controller. If the level of daylight is not sufficient for the setpoint, artificial lighting is added until the setpoint brightness is achieved.

This behaviour ensures that only energy necessary to ensure the optimum level of brightness is used. The energy consumption can be reduced further if additional presence detectors, e.g. ABB i-bus[®] Presence Detectors BW/S or Presence Detector PM/A are integrated into the system. In this way the light and the light control can only be switched on if there are persons located in the room. Many studies¹⁾ have shown that use of a constant light control can save up to 50 % (see chapter [Annex](#)) of the energy used.

¹⁾ Literature source: Zentralverband Elektrotechnik- und Elektroindustrie e.V. (ZVEI) - (German Electrical and Electronic Manufacturers' Association).

4.7.1 Constant lighting control properties

4.7.1.1 Changing the setpoint

Depending on the intended purpose of the room or area, e.g. training or competition areas in sports halls, it may be useful to apply a changeable setpoint for the constant lighting control via the KNX. The *Setpoint* object is provided for this purpose. Commissioning with artificial lighting and daylight is implemented using the setpoint which is most frequently used with normal operation. Here the characteristic of the lighting is recorded by the Light Controller and stored to ensure optimum light control.

Procedure

If this has not already been undertaken, the Light Controller is calibrated with the brightness setpoint (1) used primarily during operation. A detailed procedure is described in the [commissioning/calibration](#). Setpoint 1 is read via the object *Actual value*. This value must be written again to the Light Controller when changing from setpoint 1 via the object *Setpoint*, e.g. via a visualisation or a pushbutton.

In order to determine the second setpoint brightness (2), the room is also darkened and the brightness is set exclusively using artificial lighting only. Setpoint 2 is read via the object *Actual value*. This can be written if required via the object *Setpoint* into the Light Controller, and applies from this point onwards as the new setpoint.

	Implementation	By	Effect
Determination of the setpoint value and setting via KNX			
1.	Deactivate lighting control	Send 0 to object <i>activate control</i> (No. 24).	Light control is deactivated.
3.	Slaves must be actively integrated into the lighting.	Write the corresponding <i>Activate slave mode</i> objects with 1.	The entire lighting which is effective in the light control must be active during calibration.
4.	Dim room lighting.	Blind or time of day	Brightness in the detection range of the Light Sensor less than 20 lx ¹⁾
5.	Read actual value.	Object <i>Actual value</i> (No. 30)	The actual value is equal to the setpoint value in a perfectly balanced control circuit. Control difference equal to zero. Thus it is possible to read the value (setpoint) via the actual value object.
6.	Set setpoint via KNX.	Write object <i>Setpoint</i> (No. 29) by a pushbutton or visualisation with the actual value (see 5.).	Setpoint is stored in the Light Controller and used with light control.

¹⁾ Interference of the artificial lighting calibration caused by daylight has the effect that the Light Controller assumes that the illumination can produce a larger brightness level than is actually the case. The Light Controller will set a lower level of brightness in control operation.

4.7.1.2 Deactivation of control

Constant lighting control can be deactivated by users at any time if this option has been enabled. Corresponding parameterisation options can be found in the parameter window [X: Control Operating](#).

The deactivation of the light control can for example be implemented by a local operation, dimming or switching of the lighting. Thus the user always has the option of setting their optimum brightness .

4.7.1.3 Activating constant lighting control

Before light control runs (controls), the constant lighting control must be selected on the parameter page [X: General](#) via the parameter *Enable function*. The light control is activated and controlled after the first download. With a further download the light control state before the download is restored. Light control can be activated (telegram with value 1) or deactivated (telegram with value 0) via the object *activate control*. In the activated state the light control is triggered as follows:

Constant lighting control is then activated and set to the control state when the switched off lighting is switched on (via object *Switch* a telegram with the value 1 is received).

The switch command can also be provided by a presence detector. In this case it is possible to fully relinquish manual operation of the lighting in extreme cases. This can prove to be useful if an optimum energy consumption is to be achieved, or if you must ensure that when a certain task is performed a particular level of brightness is assured.

In the following cases the light control which is in standby mode is not triggered by an ON command:

- The output is inhibited or is under forced operation.
- The *Follow-up time of the inactive control* is active.

4.7.1.4 Follow-up time of the inactive control

This function is particularly useful when there is a presence detector in the room.

Example

The user has deactivated the light control and set the maximum level of brightness. The user leaves the room and the presence detector switches off the light. If the user returns after a short time (within the adjustable follow-up time) the lighting is automatically set again to the maximum brightness value and the light control remains active. The temporary setpoint set by the user, e.g. by dimming, remains active.

4.7.1.5 Slave mode

Slave mode in a constant lighting control:

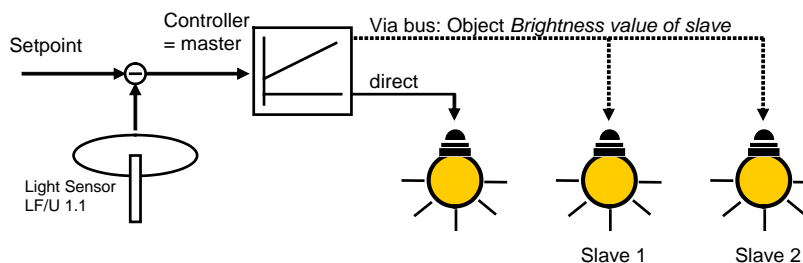

Further luminaries can be integrated into the constant lighting control which are not directly connected to the Light Controller. These for example, can be DALI lamps via an ABB i-bus® KNX DALI Gateway or a dimmer. These components are controlled directly as so-called slaves directly by the Light Controller (= master). The slaves have the same brightness value as the master if no characteristic correction is parameterised or no other brightness characteristic of the luminaries is available. The brightness value is transferred via the object *Brightness value of slave*.

Tip

It may be desirable that the lights in the vicinity of the window are darker than the lights in the interior of the room. This can be achieved by the parameterised characteristic correction in the slave. The darker lighting strip should be parameterised as the master.

For further information see: [Example](#)

Please observe here that the brightness differences should also be present at night or when it is dark!

4.7.1.6 Different luminaries

Luminaries with varying brightness characteristic curves should be avoided in control circuits. In a Light Controller control circuit a mix of 1-10 V luminaries and DALI luminaries (controlled via DALI gateways) is not possible.

This is because of the different brightness characteristic curves (linear/logarithmic) involved. The same control value, e.g. of 50 % with 1-10 V luminaries causes a brightness of 50 %, with DALI lamps a light current of 3 % will correspond to a brightness of 3 % as the curve is adapted to the logarithmic response of the eye. Because of these brightness differences at the same control value, a common lighting control (in a Light Controller control circuit) is not recommended.

A control circuit with 1-10 V luminaries and a second control circuit with DALI lamps controlled via a DALI Gateway must however be controlled via two separated outputs of a single Light Controller.

4.7.2 Positioning of the Light Sensor

The Light Sensor measures the brightness (light density) of an area in a room which is suitable for a reference measurement. Positioning should be undertaken as follows:

1. The Light Sensor should be situated directly above the reference surface, e.g. workbench. Observe the detection range of the Light Sensor.

See: [sensor polar diagram](#)

2. The ceiling must be monitored when the room is not darkened and the lighting is switched off. Those ceiling areas which are not directly subject to daylight or reflections are suitable.
3. The rod should be pushed about 15 mm deep into the device right up to the limit. The Light Sensor must be aligned with the longitudinal axis of the rod pointing vertically downwards.
4. It must be assured that the brightness sensor only measures indirect reflected light. Sunrays or light rays which shine directly into the rod lead to measurement faults, just as the incidence of light mirrored directly from surfaces.
5. The optimum installation height is between 2 and 3 m.
6. If possible measure different actual values of the Light Sensor with different lighting relationships with daylight (cloud, sun) at the same Lux count on the reference surfaces. The difference in the actual value should be minimal.

Note

Rooms are lit up differently by the incidental daylight and the artificial lighting of the lamps. Not all surfaces in the rooms, e.g. walls, floor, and furniture reflect the light which falls on them in the same manner. Accordingly, even though there is an exactly calibrated constant lighting control in daily operation, deviations to the set target value may occur. These deviations may be up to +/- 100lx should the current ambient conditions in the room, and accordingly the reflection properties of the surfaces (paper, persons, reorganized or new furniture), differ significantly from the original ambient conditions at the time of calibration. Deviations may also occur if the Light Sensor is influenced by direct or reflected light falling on it which is not influenced or only slightly influenced by the surfaces in the detection range of the Light Sensor.

4.7.3 Commissioning/calibration of the constant lighting control

Commissioning of the constant lighting control should be undertaken when the intended furnishings are in place. The technical lighting attributes of the room are influenced by the furniture and the floor coverings, e.g. reflection and absorption. This on the other hand has a direct effect on the brightness value which is detected by the Light Sensor.

If constant lighting control is set in a room which does not yet have its final configuration and changes are then made to the layout in the room, this will have a direct effect on the lighting control.

In the simplest case this can lead to larger setpoint overshoots or undershoots. In extreme cases it can lead to unstable oscillating control.

With a calibration of the constant lighting control all lamps which are controlled directly (master) or indirectly (slave) by the Light Controller are to be used. The sequence of daylight and artificial light calibration is not in any desired order. Calibration with artificial light must be performed before calibration with daylight.

Before the calibration process it is recommended that the function of the Light Sensors is checked. For this purpose set the T flag of the *Sensor value* object. Now every detected change in brightness is sent on the bus via the object *Sensor value*. If the sensor value does not change after a change in the brightness in the detection range of the Light Sensor, there is a fault. The polarity and the sensor cable should be monitored for a broken cable. After inspection of the Light Sensor function, the light control should be deactivated by a telegram with the value 0 to the object *activate control*. Now the light can be dimmed independently of the control parameterisation and the calibration of constant lighting control can commence.

Implementation of artificial lighting calibration

The sequence of daylight and artificial lighting calibration is not random. Calibration with artificial light must be performed before calibration with daylight.

The room should be darkened for this purpose. The lighting intensity in the detection range of the Light Sensor must be less than 20 lx. Interference of the artificial lighting calibration caused by daylight has the effect that the Light Controller assumes that the illumination can produce a larger brightness level than is actually the case. The Light Controller will set a lower level of brightness in control operation.

The Light Sensor is ideally vertically positioned above the monitored working surfaces. If it is not possible to darken the room, the artificial lighting calibration should be performed early in the morning or in the evening. The artificial lighting should be set using a Luxmeter so that 500 lx is measured on the reference surface. Proceed as follows for the best results:

- Switch the artificial lighting fully on.
- Wait until the Luxmeter on the reference surface indicates a stable value.
- Set the setpoint brightness.

When this constant brightness value has set, the object *Enable calibration* must be used to switch the objects *Calibration lighting* and *Calibration daylight* in a ready to receive state by sending a telegram with the value 1.

This is a security feature to ensure that a calibration is not triggered unintentionally during normal operation overwriting the set values. The objects are ready to receive for an hour or until the calibration is triggered (telegram with value 1).

The artificial lighting calibration is triggered by a telegram to the object *Calibration lighting*. At the start of the calibration process the object *Calibration lighting* is again automatically set to 0 by the Light Controller. The Light Controller saves the current brightness value as a setpoint for light control. At the same time the lighting is switched on with 100 % brightness by the Light Controller and the lighting characteristic progresses to the value 0. In this way the brightness characteristic of the lighting is stored in the Lighting Controller. The progression takes about one minute. The lighting is switched off automatically by the Light Controller. This concludes the artificial lighting calibration. The Light Controller switches on the lighting and activates the light control. The end of artificial lighting calibration is indicated when the value 0 from the object *Calibration lighting* is sent on the bus. The T flag must be set for this purpose.

As an example, short operating instructions for output A are listed for artificial lighting calibration:

	Implementation	By	Effect
Artificial lighting calibration¹⁾			
1.	Checking the Light Sensor	Set T flag object <i>Sensor value</i> (No. 32). Partial download is sufficient. Observe the sensor value.	The sensor value must change with a change in the brightness value.
1a.	Check the Light Sensor position.	See Positioning of the Light Sensor	Sensor value is not subject to interference.
1b.	After checking the Light Sensor.	Reset the T flag object <i>Sensor value</i> (No. 32). Partial download is sufficient.	Reduction of the bus load in normal operation.
2.	Deactivate lighting control	Send 0 to object <i>activate control</i> (No. 24).	Control is deactivated.
3.	Slaves must be actively integrated into the lighting.	Write the corresponding <i>Activate slave mode</i> objects with 1.	The entire lighting which is effective in the control must be active during calibration.
4.	Dim room lighting.	Blind or time of day.	Brightness in the detection range of the Light Sensor less than 20 lx ²⁾
5.	Set the artificial lighting so that the setpoint brightness is set to the reference point. The Light Sensor should be positioned above the reference surface.	Dimming via object <i>Relative dimming</i> (No. 12).	Setpoint is set, e.g. 500 lx. Luxmeter is positioned vertically below the Light Sensor.
6.	Switch calibration object to ready to receive.	Send a telegram with the value 1 to object <i>Enable calibration</i> (No. 25).	Object <i>Calibration lighting</i> and <i>Calibration daylight</i> are ready to receive for 1 hour.
7.	Initiate artificial lighting calibration.	Send a telegram with the value 1 to object <i>Calibration lighting</i> (No. 26).	Control commences calibration of artificial lighting. Jump to 100 % brightness. Dimming to 0. The calibration is completed after about 1 minute. At the start of calibration the value of the object <i>Enable calibration</i> (25) is reset to 0.
8.	End daylight calibration.	Automatic via LR/S.	Control active and controlling. At the end of calibration the object <i>Calibration lighting</i> (26) is reset to 0.

¹⁾ Before the artificial lighting calibration ensure that the luminaries feature a constantly reproducible dimming performance during dimming. For this purpose the burn-in time ([Effect of ageing on lamps](#)) of the luminaries must be considered and already completed. Consider also that some fluorescent lamps only develop their full lighting intensity after a few seconds.

²⁾ Interference of the artificial lighting calibration caused by daylight has the effect that the Light Controller assumes that the illumination can produce a larger brightness level than is actually the case. The Light Controller will set a lower level of brightness in control operation.

Automatic implementation of daylight calibration

The sequence of daylight and artificial lighting calibration is not random. Calibration with artificial light must be performed before calibration with daylight.

The daylight calibration can be undertaken automatically by the Light Controller or experimentally by the user. The required setting can be found in the parameter window [X: Control](#) with the parameter *Compensation factor for daylight calibration automatically*. Automatic calibration is preferred.

The artificial lighting should be turned off for daylight calibration.

The same brightness level (setpoint) as artificial lighting can generally be created using shading units. In order to prevent with a high level of certainty that the setpoint is not undershot in the controlled state, a brightness can be set for the daylight brightness which is about 10 % above the brightness value of artificial brightness calibration.

Via the object *Enable calibration* it is recommended that the readiness to receive of the object *Calibration daylight* is undertaken. The calibration can be undertaken by a telegram with value 1 sent to the object *Calibration daylight*. The Light Controller undertakes the calibration and determines the levels (weighting) of artificial lighting and daylight. After this calibration the Light Controller switches the setpoint and commences with lighting control. When the daylight calibration has ended the value of the object *Calibration daylight* is set again to 0. The T flag should be set beforehand. The value can be read as an alternative. At the start of daylight calibration the value of the object *Enable calibration* (25) can be detected. At the start of daylight calibration this object value is set to 0 by the Light Controller.

If a shading device is not available for use or the daylight is not sufficient, a manual daylight calibration can be undertaken.

As an example short operating instructions for output A are listed for automatic daylight calibration:

	Implementation	By	Effect
Daylight calibration			
0.	Calibration lighting	See Artificial lighting calibration table	Lighting characteristic stored in the Light Controller.
1.	Deactivate lighting control	Send 0 to object <i>activate control</i> (No. 24).	Control is deactivated.
2.	Switch off artificial lighting.	Send 0 to object <i>Switch control</i> (No. 10).	Artificial lighting switched off.
3.	Set the setpoint brightness, e.g. 500 lx with daylight.	The same setpoint can be set using blinds or time of day as with artificial lighting calibration. Note: In order to prevent with a high level of certainty that the setpoint is not undershot in the controlled state, a brightness about 10 % above the brightness value of artificial brightness calibration is set.	Setpoint is set, e.g. 500 lx. Optional manual calibration possible.
4.	Switch calibration object to ready to receive.	Send a telegram with the value 1 to object <i>Enable calibration</i> (No. 25).	Object <i>Calibration lighting</i> and <i>Calibration daylight</i> are ready to receive for 1 hour.
5.	Initiate daylight calibration.	Send a telegram with the value 1 to object <i>Calibration daylight</i> (No. 27).	Control commences calibration of daylight. Calibration has ended after about 10 seconds. At the start of the daylight calibration the object <i>Enable calibration</i> (No. 25) is again set to 0.
6.	End of daylight calibration.	Automatic via LR/S.	Control active and controlling. Value of the object <i>Calibration daylight</i> (No. 27) is reset to 0.

¹⁾ Before the daylight calibration ensure that the luminaries feature a constantly reproducible dimming performance during dimming. For this purpose the burn-in time (see section 4.7.4) of the luminaries must be considered and already completed. Consider also that some fluorescent lamps only develop their full lighting intensity a few seconds after being switched on.

Manual implementation of daylight calibration

If a daylight calibration is not possible, for example, because the setpoint is not reached with the available daylight or a shading option is not available to darken the detection range of the Light Sensor so that the setpoint can be set, manual daylight calibration can be undertaken.

First of all set in the parameter window [X: Control](#) the parameter *Compensation factor for daylight calibration automatically* to *no*.

Subsequently a factor between 0 and 99 can be entered.

This factor defines the relationship between daylight and artificial lighting. A larger value compensates more for daylight. A smaller value on the other hand gives a higher weighting to artificial lighting. After the factor has been transferred for download in the Light Controller using the brightness measured in the detection range of the Light Controller by the Luxmeter. More artificial lighting is required if the desired setpoint is undershot. This is achieved by increasing the factor. Too much artificial lighting is available if the desired setpoint is exceeded. The artificial lighting share must be reduced. This is implemented by reducing the factor. This is repeated until the light control controls the required brightness.

As an example in the following, short operating instructions for output A are listed for manual daylight calibration:

The calibration should be performed preferably at two measurement points, e.g. at a setpoint of 500 lx, the light control should be performed in daylight from about 200 lx and 400 lx.

	Implementation	By	Effect
Manual daylight calibration			
1.	Enable manual daylight calibration.	In Parameter window X: <i>Control</i> the parameter <i>Compensation factor for daylight calibration automatically</i> is to be set to <i>no</i> .	Parameter for the assignment of a factor for daylight calibration is enabled.
2.	Load the factor for daylight calibration in the Light Controller.	Download	The factor is stored in the LR/S after download. Light control is started.
3.	Checking of controlled brightness value.	The brightness is to be measured in the detection range of the Light Sensor with the Luxmeter.	The factor must be reduced if the constant brightness to be set is greater than the required setpoint. The factor must be increased if the brightness is too small. Step 2 should be repeated until the required brightness is set.
<pre> graph TD A[Set factor for daylight calibration in ETS] --> B[Download] B --> C[Measure brightness value with Luxmeter at reference location] C --> D{Measured value = Setpoint} D -- smaller --> E[Increase factor] E --> A D -- larger --> F[Reduce factor] F --> A D -- Same or acceptable --> G([End]) </pre>			

Note

After a reset or discharge of the Light Controller via the ETS, the stored values, e.g. lighting characteristic curves, are still available to the Light Controller. The calibration must be performed again.

The values are overwritten only after a new calibration. The artificial lighting and the daylight calibrations should be considered separately in this case.

This is independent of if the calibration has been performed manually or automatically.

The artificial lighting and daylight calibration must be performed again with a change of the Light Sensor arrangement.

4.7.4 Effect of ageing on lamps

Every fluorescent lamp ages in service. The lighting power of the fluorescent lamps degrades, i.e. a lower brightness is produced at the same control value. This can even mean that the setpoint originally required can no longer be achieved with maximum control. For this reason the lighting is to be dimensioned so that the required setpoint brightness can be achieved until the luminaries are routinely exchanged.

In principle the ageing luminaries have no effect on the control circuit. If a lower brightness level is achieved due to ageing of the luminaries with the same control, the Light Controller will continue to increase the level of artificial lighting until the setpoint brightness is achieved.

However, it must be considered that the characteristic of the luminaries changes with ageing. The characteristic has been determined during the calibration procedure and is the basis for the control algorithm. In this way it is possible that light control discrepancies result.

The following approach results:

The recorded characteristic of the artificial lighting is calculated with the control value. Assuming that the lamp generated 30 % less light, the value of the characteristic would be 1.33 times larger than the real value.

The Light Controller "thinks" that the daylight share is less than it is in reality. For the Light Controller there is less daylight as compensation is required.

With a compensation factor of 30 (for the control algorithm 0.3) an approximate reduction of the setpoint value by 10 % would be achieved. The Light Controller would control to a level which is too dark by 10 %.

In concrete terms that would mean that a light control originally set by the Light Controller to 500 lx will now only provide a brightness value of 450 lx. Furthermore, the tolerances apply as described in the [Technical data](#).

Note
<p>The burn-in time where the light may not be dimmed must be complied with to ensure that the most stable possible luminaire performance is assured. During the burn-in time which usually lasts between 50 and 100 hours, the luminaries must be operated at 100 % brightness.</p> <p>The burn-in time of a luminaire can be obtained from the manufacturer.</p>

4.7.5 How does brightness detection function

The Light Sensor LF/U 2.1 of the LR/S x.16.1 detects the light intensity of the surfaces in its detection range and converts it to a current. Before the light reaches the photodiode, it passes through a light filter whose maximum pass band attributes are in the visible wavelength range of the human eye. The light intensity is on the one hand dependent on the lighting intensity, i.e. the intensity of the daylight or artificial lighting, and on the other hand on the characteristics of the surfaces which are illuminated. If the surfaces in the detection range of the Light Sensor are completely covered with white paper, the Light Sensor measures a different light intensity with the lighting intensity as when the surface is covered with grey environmentally-friendly paper. When setting the setpoint the light density is measured by the Light Sensor and stored as a setpoint value. Subsequently, the light control will control the artificial lighting level in the room so that it more and more accurately achieves this setpoint value, i.e. the lighting control attempts to keep the lighting density and not the lighting intensity at a constant level.

4.7.6 Function of the constant lighting control

The task of a constant lighting control is to control the setpoint brightness which results at a reference point in the room as accurately as possible. Starting from the actual brightness, the setpoint brightness is approached in steps (brightness change over time).

A control step is defined by the increment (brightness change) and the step time (time duration) in which the brightness change is performed.

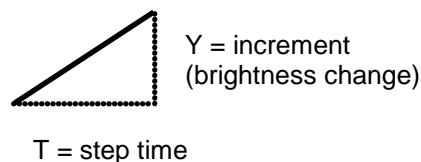

In principle, simplified light control can appear as follows. In the following example, the setpoint brightness is achieved starting from an actual brightness level to a setpoint brightness level in three steps:

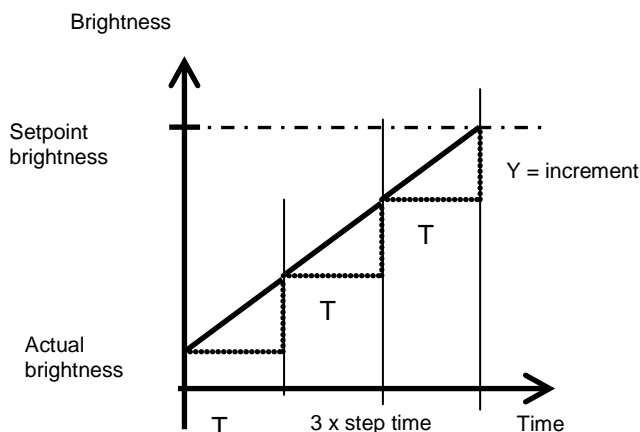

If the increment is too large, the light control reaches the setpoint faster. The setpoint brightness is exceeded. The Light Controller starts to oscillate around the setpoint brightness.

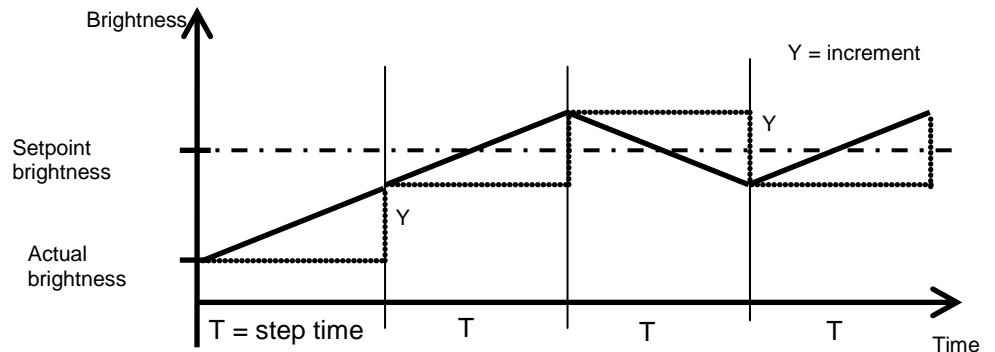

If the increment is too small, it will take too long until the setpoint brightness is reached. This is critical particularly where blinds which are closing to darken the room quickly.

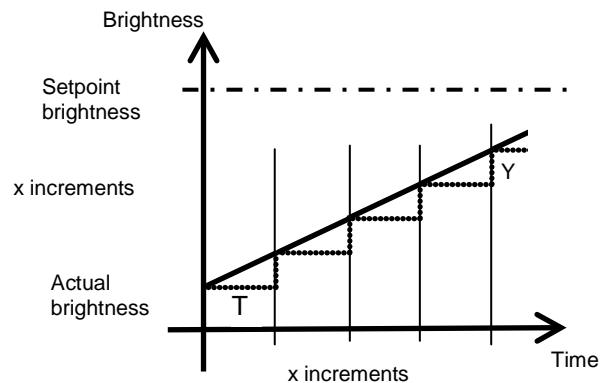

The increment time should be selected so that the brightness change of a control step is available via the Light Controller/luminaire/Light Sensor before the next control step is triggered. Otherwise the brightness setpoint will be exceeded and has to be regulated back a step. Normally the Light Controller determines these control variables.

If required these variables can be set individually in the parameter window [X: Control Dynamics](#). The parameter window [X: Control Dynamics](#) is visible if in the parameter window [X: Control](#) the parameter *Changing brightness during lighting control* is set to *individual setting*. The parameterised variables are written in the following illustration.

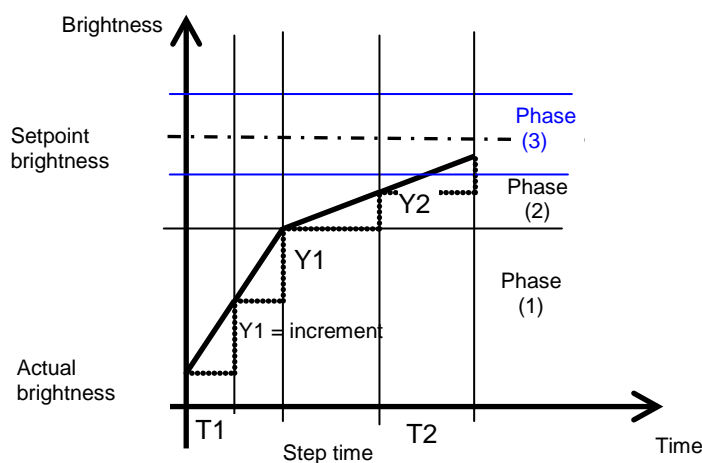

In the start-up phase (1) the increment time ($T1$) of the control step can be parameterised. The smaller this time, the faster that the control steps are sent with the calculated step increment ($Y1$). The setpoint brightness is approached in a relatively short time.

If the difference between the setpoint brightness and the actual brightness has undershot a parameterised value, the fine tuning phase (2) in which the *Step time for fine tuning* ($T2$) slowly approaches the setpoint value.

The increment ($Y2$) can also be parameterised. To reach the setpoint faster or slower. This increment only is valid until a determined interval to the setpoint value. This interval can be set via the parameter *Control deviation for high increments (max. control step)*.

Phase (3) is adjustable with an additional parameter in which light control is suspended. A range around the setpoint value where there is no light control must be parameterised. Only when the actual brightness is again larger than this difference will the light control recommence. In this way continuous control with the respective changes in brightness is avoided. This generates smoother and less abrupt response and considerably reduces the bus load with a master/slave control.

In order to get a point of reference for the individual control parameterisation, in the following table, you will find the fixed parameterised settings in the Light Controller and/or the adjustable values via the parameter window [X: Control Dynamics](#) listed for the *Changing brightness during lighting control* (*fast, medium, slow* and the *individual setting*):

Changing brightness during lighting control	Fast	Medium	Slow	Individual setting
Max. time between two control steps [0.1 s...2.0 s]	as fast as possible	0.5	1	1
Step time for slow approach [1 s...10 s]	2	3	4	4
Control deviation for medium dimming speed [0...50]	20	20	20	20
Maximum increment size of a control step [1...10]	1	1	1	1
Control deviation for high increments (max. control step) [10...255]	30	30	30	30
Control deviation for high increments [0...30]	1	1	1	1

4.8 Slave mode

The reaction to the switch on telegram with the value 1 to the object *Switch* can be parameterised. If the slave operation is activated, the Dim actuator output strictly adheres to the brightness value, which is predefined by the object *Brightness value of slave*. Brightness values on the object *Brightness value* are ignored. A telegram with the value 0 on the object *Activate slave mode* deactivates slave mode. A telegram with the value 1 switches on slave mode again. This activation or deactivation is also displayed in the first bit of the status byte.

A switch off telegram with the value 0 on the object *Switch* has the effect that the slave mode is deactivated. In this case, the slave mode is in a standby state and waits in the background for renewed activation. A renewed activation can be implemented by a telegram with the value 1 to the object *Switch* or via the object *Activate slave mode*. As in standby mode, the slave mode continues to be active in the background and is waiting for activation, the first bit in the status byte will always indicate the activated slave mode with the value 1.

The same behaviour results when in parameter window [X: Slave](#) you parameterise that a dim, switch, value command, preset or scene recall deactivates slave operation. Slave mode is in standby and can be reactivated via a telegram with the value 1 sent to the object *Switch* or via the object *Activate slave mode*.

The parameterisation *no reaction* has the effect that no dim, switch and value command can be executed. Also a preset or scene recall and storing of a scene has no effect.

The slave mode remains activated. However, using the object *Set preset* a new brightness value for a preset can be saved.

The parameterised value limits in the parameter window [X: Value](#) also apply for the slave mode. The undershoot and overshoot of these limits are set using the parameterised minimum or maximum brightness value. If the master sends the brightness value 0 the lighting is switched off.

The behaviour of the slave mode after bus voltage recovery can be parameterised.

An integration of further ABB i-bus® components in the Light Controller can typically appear as follows:

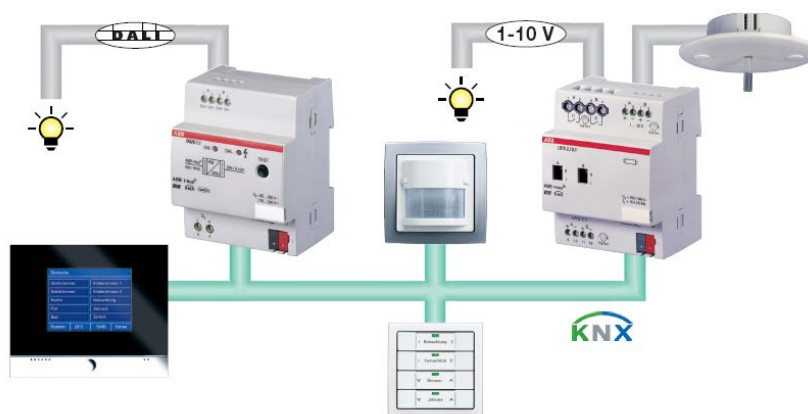

4.9 Behaviour with bus voltage failure, recovery, download and ETS reset

Reaction on bus voltage failure

The switching behaviour (relay position) can be parameterised. The control output assumes a high resistance state, i.e. that the ballasts assume the maximum brightness (100 %).

Reaction on bus voltage recovery

The behaviour of the device after bus voltage recovery can be parameterised for each output, see parameter window [X: General](#). It is possible to write the object *Switch* with a 1 or 0 or to restore the state of the bus voltage failure.

An initialisation phase lasting about two seconds occurs directly after bus voltage recovery. Thereafter, the following communication objects send their current values :

Object/Function	Name	Remark:
In operation	General	Is sent
Status function	General	Is sent
Switch/Status or Status switch	Output X	Is sent
Status brightness value	Output X	Is sent
Forced operation	Output X	Information is displayed via the status byte
Block	Output X	Information is displayed via the status byte
Warning staircase lighting	Output X	Is sent
Brightness value of slave	Output X	Is sent
Status byte	Output X	Is sent

The additional functions behave as follows:

The behaviour of the additional function *Slave mode in lighting control* is parameterised after bus voltage recovery in the parameter window [X: Slave](#). It is possible to activate slave mode, i.e. the slave ready object *Brightness value of slave* and sets the respective brightness. With *inactive* the values received via the object *Brightness value of slave* are not executed.

The additional function *Staircase light* and *Light control* are always activated after bus voltage recovery (bit 0 in status byte has the value 1).

If *Permanent ON* was active before bus voltage failure, *Permanent ON* will be rescinded with bus voltage recovery. The additional function is again enabled and reacts to incoming telegrams.

Via the parameter *Value of object "Switch" on bus voltage recovery* in the parameter window [X: General](#) you can also define whether the light switches on (staircase light or light control running) or switches off (operating on the basis brightness / or does not control). If the parameter *restore status before failure* is selected, the value of the object *Switch* before bus voltage failure is written again to the object *Switch* after bus voltage recovery and the function complying to the value is undertaken.

If the additional function *Staircase light* function was deactivated before bus voltage failure (bit 0 in the status byte has the value 0), the staircase light is activated again. Depending on the parameterised object value *Switch* at bus voltage recovery the staircase light function will time out or the basis brightness value is set. The Light Controller controls or is in standby mode.

If the *Block* function was active, the blocking of the device is cancelled at bus voltage recovery. The additional function of the output is continued.

Reaction of download or ETS reset

The brightness value remains unchanged during and directly after the download or ETS reset. The additional functions (staircase light, light control and slave mode) as well as forced operation and blocking of the output remain unchanged.

If another or an additional function was parameterised before download, the following applies for the new additional function:

The *Staircase light* function is active and the object *Activate staircase* function is written with the value 1.

If the base brightness was set for the staircase light before download, it will be set again.

If the staircase light was not active before download it will remain deactivated after the download.

If the staircase light was dimming before download, it will be set to base brightness after download.

The function *Light control* and *Slave mode* are active and the objects *activate control* or *Activate slave mode* are written with the value 1. Bit 0 in the status byte has the value 1. The light control commences with the parameterised switch on brightness.

The special behaviour is summarized in the following table.

Note
<p>After a reset or discharge of the Light Controller via the ETS, the stored values, e.g. lighting characteristic curves, are still available to the Light Controller. The calibration must be performed again.</p> <p>The values are overwritten only after a new calibration. The artificial lighting and the daylight calibrations should be considered separately in this case.</p> <p>This is independent of if the calibration has been performed manually or automatically.</p> <p>The artificial lighting and daylight calibration must be performed again with a change of the Light Sensor arrangement.</p>

Behaviour of the fan stage after download, ETS bus reset voltage failure and recovery

Behaviour with	Bus voltage failure (BF)	Bus voltage recovery (BW)	Download	ETS bus reset Reset device
Switch behaviour (relay position)	Programmable (X: General)	Object value <i>Switch</i> is parameterised (X: General)	State as before the download	State as before the reset
1-10 V output	Assumes high resistance, ballasts go to 100 %	Dependent on parameterisation "Switch object after bus recovery." Unchanged: Brightness before bus failure Value 1: Brightness = 100%	Control output and thus the brightness value remain unchanged.	Control output and thus the brightness value remain unchanged.
Block	No function, see relay position	Blocking is removed	Blocking is removed	Blocking is removed
Forced operation	No function, see relay position	Programmable (X: Function).	Is forcibly deactivated, brightness remains unchanged.	Is forcibly deactivated, brightness remains unchanged.
Scenes	No function, see relay position	Inactive, via bus saved scene values remain available	Inactive, scene values are overwritten depending on the parameterisation (X: Function)	Inactive. Values stored via bus still available for recall
Presets	No function, see relay position	Preset is written with the parameterised standard value in the ETS	Preset is written with the parameterised standard value in the ETS	inactive
Object <i>Switch status</i> , <i>Status brightness value</i>	No function, no data is sent	Will be updated and depending on parameterisation (X: General) will be sent	Will be updated and depending on parameterisation (X: General) will be sent	Will be updated and depending on parameterisation (X: General) will be sent
Dimming speed 0...100%, set via bus	Dimming speed is lost. no function	The set dimming speed set via the bus is lost and is replaced by the ETS programmed time.	The set dimming speed set via the bus is lost and is replaced by the ETS programmed time.	The set dimming speed set via the bus is lost and is replaced by the ETS programmed time.
Staircase lighting	No function, see relay position	Staircase light function active, reaction dependent on <i>Switch</i> object	State as before the download	State as before ETS bus reset
Permanent ON	No function, see relay position	inactive	inactive	Inactive, brightness is retained
Slave mode	No function, see relay position	Is programmable (X: Slave)	State as before download, <i>Brightness value of slave</i> object	State as before reset, <i>Brightness value of slave</i> object will be read
Status byte	no function	Values are updated and sent	Values are updated and sent	Values are updated and sent
Last brightness value	The last brightness value is saved.	As long as the last value is known, is switch on with 100 % or maximum value	Last brightness value is still known.	Last brightness value is still known.

Behaviour of the fan stage after download, ETS bus reset voltage failure and recovery

Behaviour with:	Bus voltage failure (BF)	Bus voltage recovery (BW)	Download	ETS bus reset <i>Reset device</i>
Control activated	No function, see relay position	Light control active, reaction dependent on <i>Switch</i> object	State as before download is restored	State as before ETS bus reset is restored
Object <i>Status function</i>	No function, no values can be sent	Is updated and sent on the KNX	Is updated and sent on the KNX	Is updated and sent on the KNX
Artificial lighting / Daylight calibration	Calibrated values are retained	Calibrated values are retained	You can parameterise if the manually entered value for daylight calibration is overwritten.	Calibrated values are retained
Temporary setpoint (by dimming)	Is not saved and is lost	The value parameterised in the ETS is set. Setpoint defined via bus is lost.	Scene overwritten on download	Value accepted from ETS
Dimming speed set via object	Is not saved and is lost	The value parameterised in the ETS is set. Speed defined via bus is lost.	Scene overwritten on download	Value accepted from ETS
Staircase light time set via bus	Is not saved and is lost	The value parameterised in the ETS is set. Time defined via bus is lost.	Scene overwritten on download	Value accepted from ETS

4.10 Interdependence of the functions

The functions have the dependence to one another:

With the exception of the behaviour at bus voltage failure and recovery, the highest priority is forced operation, which is triggered with the 2 bit or 1 bit object *Forced operation*. The output is blocked with forced operation. At the same time the value of the object *Forced operation* of the output is switched on (object value 3 or 11) or off (object value 2 or 10) with a parameterised brightness value. The additional functions slave mode, staircase light and light control continue to run in the background during forced operation. The brightness is not influenced by this measure. During active forced operation the blocking of the outputs can be triggered or removed. At the end of forced operation the blocking is checked and implemented if necessary.

The second highest priority is the function *Blocking*. With this function the output is blocked via the 1 bit object *Blocking* (value 1), i.e. no switch, dim or value commands are carried out. The brightness value is frozen at its present level after completion of a dimming, scene or preset transition. The staircase lighting function and the slave mode are interrupted. If the output receives a telegram with the value 0 via the object *Blocking*, the channel is re-enabled and the brightness value active before blocking is set again. The staircase lighting continues in the background until dimming. The dimming is implemented again after the end of blocking. Slave mode is again implemented.

The *Permanent ON* (with parameterised Staircase light function) function has a lower priority than forced operation and blocking. After ending of forced operation or blocking the *Permanent ON* function is no longer active. Permanent ON interrupts the staircase lighting function, the timer runs in the background until the start of dimming. You can parameterise if the staircase lighting function is restarted after the end of *Permanent ON* or if it remains in a standby state.

The additional functions *Slave mode in lighting control*, *Staircase light* and *Light control* have equal priority and can not be activated simultaneously. An output can either be operated with light control, staircase lighting or slave function.

The parameterized behaviour with bus voltage failure or recovery acts directly on the switching contacts and thus has the highest priority.

A graphic representation with the active principles of the priorities is described in chapter [Function chart](#) in a flow chart.

A Appendix

**A.1 Table for the
Status byte object**

Object value		Forced operation is active	Blocking function is active	Light control, staircase light or slave-mode in light control active
dec	hex			
0	00			
1	01			1
2	02		1	
3	03		1	1
4	04	1		
5	05	1		1
6	06	1	1	
7	07	1	1	1

Meaning of the *Status byte* object

- *Forced operation is active (1)*: The output via which the communication object is forcibly operated is forcibly switched on or off and blocked for every operation.
- *Blocked function is active (1)*: The output used for the communication object *Block* is blocked for every operation.
- *Light control, staircase light or Slave mode in lighting control active*
One of these additional functions is active.

**A.2 Code table
8 bit scene telegram**

The following table indicates the telegram code for an 8 bit scene in hexadecimal and binary code with the first 64 scenes. Normally when retrieving or storing a scene an 8 bit value must be sent.

A.3 Table for the object *Status function*

Bit No.		7	6	5	4	3	2	1	0
8 bit value	Hexadecimal	Not used in L/R/S	Not used in L/R/S	Not used in L/R/S	Not used in L/R/S	Additional function runs output D	Additional function runs output C	Additional function runs output B	Additional function runs output A
0	00								
1	01								☐☐☐☐
2	02							■	
3	03							■	■
4	04						■		
5	05						■		■
6	06						■	■	
7	07						■	■	■
8	08					■			
9	09					■			■
10	0A					■		■	
11	0B					■		■	■
12	0C					■	■		
13	0D					■	■		■
14	0E					■	■	■	
15	0F					■	■	■	■

This code table applies for the object *Status function* (No. 3).

In the table ■ = additional function runs; Light Controller controls, staircase light runs, slave receives no brightness value.

The operating status refers to the state of the additional functions, i.e. is the staircase lighting time running, is the light controller running or does the slave receive a brightness value via the object *Brightness value of slave*.

Every bit defines the operating state of an output. The first bit belongs to output A, the second bit to output B. For the four-fold Light Controller the third and fourth bits define the states of outputs C and D:

Telegram values: 0 = additional function latent, and is not undertaken
 1 = additional function runs; Light Controller controls, staircase light runs, slave receives no brightness value

Note: The information regarding if the additional function is actually active can be queried via the first bit of the status byte of the output, or directly via the respective object *Activate xy* (xy = control, staircase light, slave mode).

A.4 Terminology in lighting technology

If the Light Controller LR/S x.16.1 (X = 1 or 2) is used for the constant lighting control, the Light Sensor LF/U 2.1 measures the light density of the illuminated area in its detection range, e.g. of the floor or the desk.

However, with the Luxmeter used for setting the constant lighting control, we measure the lighting intensity, i.e. the light flux which shines on the measurement sensor of the Luxmeter.

These different measurement methods can – but must not necessarily – lead to the state where the constant lighting control does not correctly function in practice.

This is not an ABB-specific phenomena but rather is the case for all constant lighting controls which function according to this principle.

Different lighting technology terms are explained in the following to improve understanding of what is involved.

A.4.1 Lighting intensity

A lighting intensity measurement device referred to as a: Luxmeter, measures the **lighting intensity** E in lx (Lux), i.e., the intensity which is used to illuminate a surface in the unit lx (Lux).

The lighting intensity E is defined as follows:

$$E = \phi / A$$

E = lighting intensity in lx (Lux)

ϕ = luminous flux in lm (Lumens)

A = illuminated surface area m²

The lighting intensity detects the luminous flux which originates for a luminaire and which shines on a defined surface. In order to measure the lighting intensity the Luxmeter must point in the direction of the light source, i.e. to the light or the sun.

Some examples for lighting intensities:

Cloudless summers day up to	100 000 lx
Overcast winters day	20 000 lx
Office lighting	500 lx
Dark winters day	400 lx
Full moon night	0.3 lx

The Luxmeter for measurement of the lighting intensity is comparable to a directly measuring photometer used by professional photographers, which is pointed directly at the sun in order to determine the correct film exposure settings.

The lighting intensity does not actually say anything about the apparent brightness on the eye as the brightness of the observed surface is not detected with the lighting intensity.

A.4.2 Light density

The **Light density** L in cd/m² (cd = Candela) is a measure of the apparent brightness which the illuminated surfaces gives to the eye.

A light density measurement device detects the reflected light, in other words the brightness of an illuminated surface. The effect of the illumination can only be evaluated over the light density of all surfaces in the range of vision.

The light density of a visual object is independent of the visual distance. The brightness does not change when the distance increases.

If white paper is subject to a lighting intensity of 500 lx, then the light density is about 130-150 cd/m². At the same lighting intensity environmentally-friendly paper has a light density of about 90-100 cd/m².

The luminance is defined as follows:

$$L = I / A$$

L = light density in cd/m²

I = luminous intensity in cd

A = surface area in m²

A.5 Energy efficiency potential with domestic and intelligent installation systems

Graphic representation of the study results of the ZVEI report concerning potential for savings using interdisciplinary intelligent installation systems.

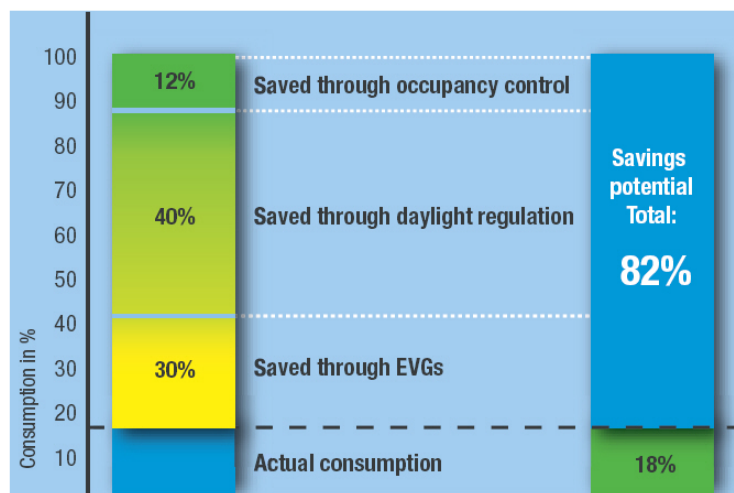
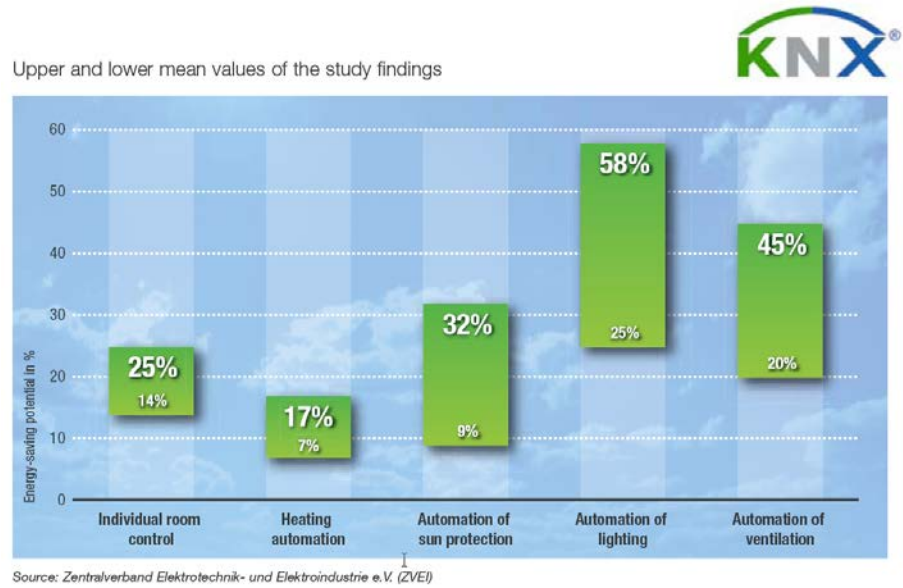

**A.6 LR/S x.16.1
scope of delivery**

The ABB i-bus® KNX Light Controller LR/S is supplied together with the following components. Please check the items received using the following list.

- 1 pcs. LR/S x.16.1¹⁾, MDRC
- 1 pcs. Installation and operating instructions
- 1 pcs. Bus connection terminal (red/black)

¹⁾ x = number of outputs (2 or 4)

**A.7 LF/U 2.1
scope of delivery**

The ABB i-bus® Light Sensor LF/U 2.1 is supplied together with the following components. Please check the items received using the following list.

- 1 pcs. LF/U 2.1, FM
- 1 pcs. Installation and operating instructions
- 1 pcs. Sensor conductor terminal (yellow/grey)
- 1 pcs. Cover
- 2 pcs. Fibre-optic rods (clear and painted white)

A.8 Ordering information

Short description	Designation	Order No.	bbn 40 16779 EAN	Price group	Weight 1 pc. [kg]	Packaging [pc.]
LR/S 2.16.1	Light Controller, 2-fold, MDRC, MB ¹⁾ 4	2CDG 110 087 R0011	6640 59	26	0,2	1
LR/S 4.16.1	Light Controller, 4-fold, MDRC, MB ¹⁾ 6	2CDG 110 088 R0011	6648 99	26	0,33	1
LF/U 2.1 ²⁾	Light Sensor, FM	2CDG 110 089 R0011	6641 65	26	0,4	1

¹⁾ MB = module width

²⁾ Not suitable for LR/S 2.2.1 and LR/M 1.6.1



The technical details in this publication are subject to change without notice.

Pub. No. 2CDC 507 086 D0201

Your KNX-Partner

www.abb.com/knx