PRODUCT MANUAL

ABB i-bus® KNX

TR/A 1.1

Time Receiver GPS



Contents		Page
1	General	3
1.1	Using the product manual.....	3
1.1.1	Notes	4
1.2	Overview of product and functions	5
2	Device technology	7
2.1	Technical data	7
2.2	Connection diagram	9
2.3	Dimension drawing	10
2.4	Mounting and installation	11
3	Commissioning	13
3.1	Overview.....	13
3.2	Parameters	13
3.2.1	Parameter window <i>Time standard – Date/Time</i>	14
3.2.2	Parameter window <i>Time standard – Daylight saving time</i>	16
3.2.3	Parameter window <i>GPS coordinates and sun data – GPS coordinates</i>	22
3.2.4	Parameter window <i>GPS coordinates and sun data – GPS sun data</i>	24
3.2.5	Parameter window <i>GPS coordinates and sun data – Fault and state interval</i>	27
3.2.6	Parameter window <i>Time switch Standard – Settings</i>	29
3.2.7	Parameter window <i>Time switch Standard – 1st switching time</i>	30
3.2.8	Parameter window <i>Time switch Standard – 2nd switching time</i>	31
3.2.9	Parameter window <i>Time switch Astro – Settings</i>	32
3.2.10	Parameter window <i>Time switch Astro Plus</i>	34
3.2.11	Parameter window <i>Time switch Astro Plus – Astro time switch offset</i>	36
3.2.12	Parameter window <i>Time switch Astro Plus – Extra time switch</i>	37
3.2.13	Parameter window <i>Light – Light sensor</i>	40
3.2.14	Parameter window <i>Light – Light control</i>	42
3.2.14.1	Parameter window <i>Light – Threshold 1</i>	45
3.2.14.2	Parameter window <i>Light – Threshold 2</i>	49
3.2.14.3	Parameter window <i>Light – Extra time switch</i>	53
3.2.15	Parameter window <i>Temperature –Temperature sensor</i>	56
3.2.16	Parameter window <i>Temperature –Temperature control</i>	58
3.3	Group objects	64
3.3.1	Summary of group objects.....	64
3.3.2	<i>General</i> group objects	66
A	Appendix	75
A.1	Scope of delivery	75
A.2	Code table, 8 bit scene	76
A.3	Ordering details	77

1 General

The Time Receiver GPS serves as the internal clock for each KNX installation. Installed on a building's facade, it receives the time signal via the globally available GPS satellite system. As an atomic clock in each satellite continuously transmits the UTC time (Greenwich Mean Time), this time can be received anywhere in the world. If the time zone is known, the current local time can be sent into the KNX system at any time.

1.1 Using the product manual

This manual provides detailed technical information relating to the function, installation and programming of the ABB i-bus[®] KNX Time Receiver GPS TR/A 1.1. The device is explained using examples.



This manual is divided into the following chapters:

Chapter 1	General
Chapter 2	Device technology
Chapter 3	Commissioning
Chapter 4	Planning and application
Chapter A	Appendix

1.1.1

Notes

Notes and safety instructions are represented as follows in this manual:

Note
Tips for usage and operation
Examples
Application examples, installation examples, programming examples
Important
These safety instructions are used as soon as there is danger of a malfunction without risk of damage or injury.
Caution
These safety instructions are used as soon as there is danger of a malfunction without risk of damage or injury.
 Danger
These safety instructions are used if there is a danger to life and limb with inappropriate use.
 Danger
These safety instructions are used if there is an extreme danger to life with inappropriate use.

1.2 Overview of product and functions

The Time Receiver GPS is used to receive the current time and to send it on the KNX bus. This allows the Time Receiver GPS to act as the internal clock for every time switch or also for devices with time-dependent logic. Furthermore, its integrated brightness and temperature sensor can transmit additional exterior conditions on the KNX bus.

The device can be operated anywhere in the world by using the GPS signal.

The device is intended for surface mounting on the outside wall of a building. It connects to the ABB i-bus[®] via a bus connection terminal inside the device. The device can be operated, e.g. for commissioning, by applying an auxiliary voltage to the bus terminal. The physical address is assigned and the parameters are set using the Engineering Tool Software ETS.

The following information can be sent on the KNX bus:

- Time
- Geographical coordinates
- Time progression of the solar irradiation angle over the course of the day
- Sunrise time
- Sunset time
- Brightness value (via integrated brightness sensor)
- Outside temperature (via integrated temperature sensor)

Furthermore, a simple time switch and an Astro time switch are available. It is also possible to parameterize switching thresholds based on measured temperature and brightness values and to send a signal on the KNX bus if these thresholds are exceeded. This allows, for example, exterior lighting to be switched on/off based on the brightness or the heater to be switched on when the outside temperature falls below a certain value.

2 Device technology



TR/A 1.1

2CDC071011F0017

The Time Receiver GPS is a surface mounted device. Physical address assignment and device parameterization are carried out using ETS and the current application.

The TR/A 1.1 is powered via the ABB i-bus® and does not require an additional auxiliary voltage supply. The device is ready for operation after connecting the bus voltage.

2.1 Technical data

Power supply	Bus voltage	21...32 V DC
	Current consumption, bus	Maximum 10 mA
	Leakage loss, device	Maximum 300 mW
Connections	KNX	Via bus connection terminal, 2-fold (red/black) 0.8 mm Ø, single core
Operating and display elements	Push button/LED  ●	For assignment of the physical address
	LED	For indication of GPS reception
Protection degree	IP 54	To EN 60 529
Protection class	III	To EN 61 140
Isolation category	Pollution degree	2 to EN 60 664-1
KNX safety extra low voltage	SELV 24 V DC	
Light sensor	Brightness measuring range	1...220,000 Lux
Temperature sensor	Temperature measuring range	-30 °C...+55 °C

ABB i-bus[®] KNX

Device technology

Temperature range	Operation	-30...+55 °C
	Transport	-30...+55 °C
	Storage	-30...+55 °C
Ambient conditions	Maximum air humidity	max. 95% r.h., non-condensing
Design	Surface mounted device (AP)	
	Dimensions	75 x 90 x 40 mm (H x W x D)
Installation	Surface mounting; wall mounting with fixing bracket	To EN 60 715
Mounting position	Housing cover must face up	
Weight	0.09 kg	
Housing/color	Plastic housing, gray	Self-extinguishing thermoplastic
Approvals	KNX to EN 50491-3, -5-1, -5-2, -5-3	Certification
CE marking	In accordance with the EMC directive and low voltage directive	

Device type	Application	Maximum number of group objects	Maximum number of group addresses	Maximum number of assignments
TR/A 1.1	Time Receiver GPS, SM/...*	40	255	255

* ... = Current version number of the application. **Please refer to the software information on our website for this purpose.**

Note

ETS and the current version of the device application are required for programming.
 The current version of the application is available for download at www.abb.com/knx. After import into ETS, it is available in ETS under *ABB/Timer/Switch*.
 The device does not support the locking function of a KNX device in ETS. Using a *BCU code* to block access to all the project devices has no effect on this device. Data can still be read and programmed.

2.2 Connection diagram

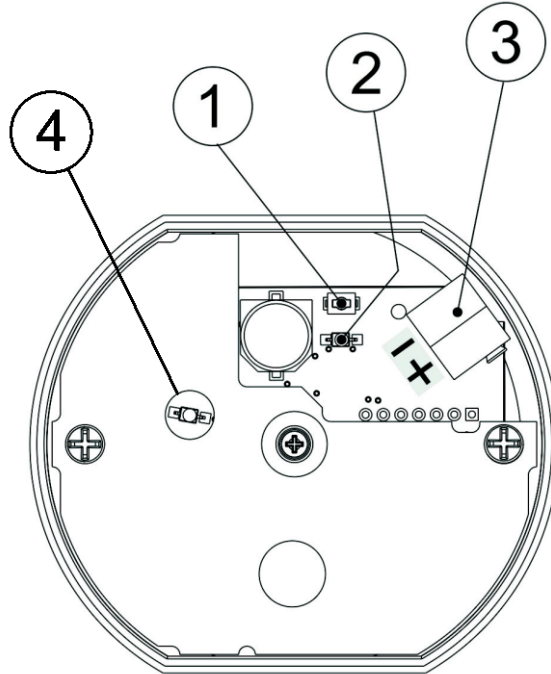

2CDC072050F0017

TR/A 1.1

- 1 Programming button
- 2 Programming LED
- 3 Bus connection terminal
- 4 GPS reception LED

2.3 Dimension drawing

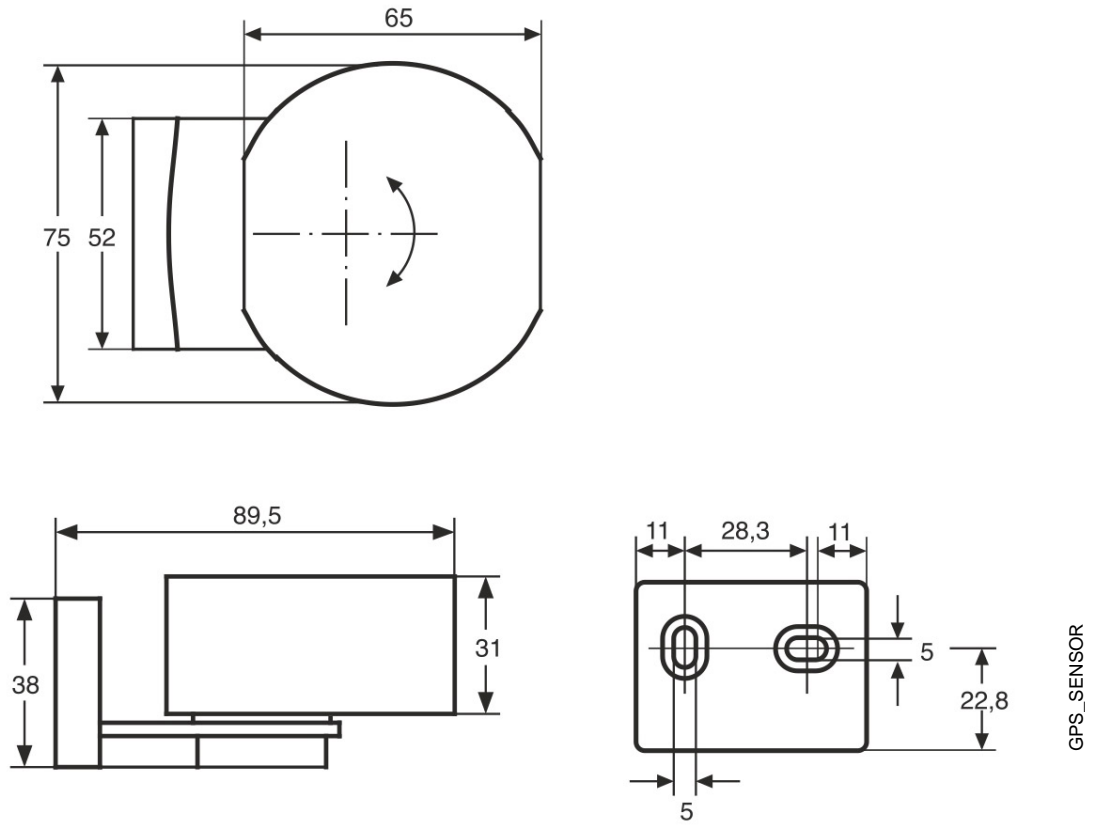

2.4 Mounting and installation

The device is a surface-mounted device for wall mounting. It is mounted using the supplied fixing bracket.

The Time Receiver GPS must be mounted on an outer wall of the building permitting good reception of the GPS signal. It therefore must not be covered. The signal LED on the device is used to check signal reception (only in connection with the KNX bus). It flashes once per second when it is receiving; it flashes faster when it is not receiving.

Furthermore, avoid shadows on the device in order to permit the most accurate brightness measurement possible. If brightness measurement by the device is to be used for blind control, it is additionally advisable to mount the device on a south-facing facade for uniform alignment with the sun throughout the day.

Note
The permissible operating temperatures could be exceeded if the device is installed in a location exposed to direct sunlight.

The device is ready for operation after connection to the bus voltage.

The devices must be accessible for the purposes of operation, testing, visual inspection, maintenance and repair in compliance with DIN VDE 0100-520.

Commissioning requirement

In order to commission the device, a PC with ETS, as well as a connection to the ABB i-bus[®], e.g. via a KNX interface, is required.

The device is ready for operation after the bus voltage is applied. No auxiliary voltage is required.

Mounting and commissioning may only be carried out by electrical specialists. The applicable standards, directives, regulations and specifications for the country in question must be observed when planning and setting up electrical installations and security systems for intrusion and fire detection.

- Protect the device from damp, dirt and damage during transport, storage and operation.
- Only operate the device within the specified technical data.
- The device should only be operated in an enclosed housing (distribution board).

ABB i-bus[®] KNX

Device technology

Supplied state

The device is supplied with the physical address 15.15.255. The application is pre-installed. Hence, only group addresses and parameters need to be loaded during commissioning.

The complete application can be reloaded if required. Downloads may take longer after a change of application or a discharge.

Assignment of the physical address

The physical address, group address and parameters are assigned and programming in the ETS.

The device features a button for assignment of the physical address. The red LED ● lights up after the button has been pushed. It switches off as soon as ETS has assigned the physical address or the button is pressed again.

Download response

Because of the complexity of the device, the progress bar for the download may take up to 90 seconds to appear depending on the PC used.

Cleaning

The voltage supply to the device must be switched off before cleaning. If devices become dirty, they can be cleaned using a dry cloth or a cloth dampened with a soapy solution. Corrosive agents or solutions must never be used.

Maintenance

The device is maintenance-free. In the event of damage (e.g. during transport and/or storage), do not carry out any repairs.

3 Commissioning

3.1 Overview

The *Time Receiver GPS/1.0* application and Engineering Tool Software ETS 4.2 or later are used to parameterize the device. The application provides comprehensive and flexible functions for the device.

3.2 Parameters

The ETS Engineering Tool Software is used to parameterize the device. The application is available in ETS under *ABB/Timer/Switch*.

This chapter describes the device parameters using the parameter windows. Parameter windows are structured dynamically so that further parameters are enabled depending on the parameterization and function of the outputs.

The default values of the parameters are underlined, e.g.:

Options: Yes
 No

3.2.1 Parameter window *Time standard – Date/Time*

The time standard settings can be made in this parameter window.

The screenshot shows a parameter window with a left sidebar and a main configuration area. The sidebar contains a tree view with the following items: 'Time standard' (expanded), 'Date/Time' (selected), 'Daylight saving time', 'GPS coordinates and sun data', 'Time switch Standard', 'Time switch Astro', 'Time switch Astro Plus', 'Light', and 'Temperature'. The main area contains three settings: 'Time offset to UTC [hh:mm]' set to '+01:00', 'Date/time by receiver or bus value' with radio buttons for 'Bus (external)' and 'Receiver (internal)' (selected), and 'Send date and time' set to 'never'.

Time offset to UTC [hh:mm]

Options: -12:00
-11:30
-11:00
...
0:00
+0:30
+1:00
...
+12:00

The time offset to UTC (Greenwich Mean Time) is set with the parameter. The time is added to the value received via GPS and then sent on the bus.

ABB i-bus[®] KNX Commissioning

Date/time by receiver or bus value

Options: Receiver (internal)
 Bus (external)

This parameter is used to select whether the internal GPS receiver is to be used to control the integrated time switches or whether the value is to be received externally via the bus.

If the option *Bus (external)* is selected, the device can no longer send the time values received via GPS on the bus.

The following parameter appears with the option *Receiver (internal)*:

Send date and time

Options: Never
 On request
 On request and automatically/cyclically

- *Never*: Sending on the bus is deactivated.
- *On request*: The 1-bit object *Bus request to send date and time – Reception* is activated. When the “On” value is received on this object, the current time and current date are sent on the bus via the corresponding objects.
- *On request and automatically/cyclically*: The 1-bit object *Bus request to send date and time – Reception* is activated. When the “On” value is received on this object, the current time and current date are sent on the bus via the corresponding objects. The dependent parameter *Cycle interval for date and time* is additionally activated.

Cycle interval for date and time

Options: Every 30 seconds
 Every minute
 Every hour
 Every 6 hours
 Every 12 hours
 At midnight
 At 00:02
 At DST
 Every hour and at DST
 Every 6 hours and at DST
 Every 12 hours and at DST
 At midnight and at DST
 At 00:02 and at DST

Depending on the selection, the date and time are correspondingly sent cyclically on the bus.

3.2.2

Parameter window *Time standard – Daylight saving time*

The parameters in this window are used to define the beginning and end of daylight saving time.

The screenshot shows a software interface for configuring time settings. On the left, a vertical list of parameters is shown with expand/collapse icons: 'Time standard' (collapsed), 'Date/Time', 'Daylight saving time' (expanded and highlighted in blue), 'GPS coordinates and sun data', 'Time switch Standard', 'Time switch Astro', 'Time switch Astro Plus', 'Light', and 'Temperature'. On the right, there is a 'Select DST rule' dropdown menu currently set to 'European DST'.

Select DST rule

Options:

- No DST
- DST according to local time
- DST according to UTC time
- European DST
- USA DST
- Australian DST

This parameter is used to set whether daylight saving time should take place and, if it should, the rule for this.

If the option *No DST* is selected, no changeover between daylight saving time and standard time takes place.

When one of the options *European DST*; *USA DST*; *Australian DST* is selected, the changeover takes place according to the rules valid for the respective region.

When the option *DST according to local time* or *DST according to UTC time* is selected, it is possible to choose a custom time for the time change. The following parameters with which the settings for the daylight saving time/standard time change can be made are enabled.

The selection *...according to local time* or *...according to UTC time* decides the time at which the following changeover times are measured.

ABB i-bus[®] KNX Commissioning

Time DST begins

Options: 0:00
0:30
1:00
...
2:00
2:30
...
+23:30

The parameter determines the time when daylight saving time should begin.

Time DST ends

Options: Same as start of DST
+1h as start of DST

This parameter defines the time when daylight saving time should end.

ABB i-bus[®] KNX Commissioning

Weekday or fixed date DST begins

Options: Weekday
Date

The parameter defines whether daylight saving time should always begin on a fixed weekday or on a fixed date.

The following parameters are displayed if *Weekday* is selected.

Week in month DST begins

Options: 1
2
3
4
Last

The parameter indicates the week of the month when daylight saving time begins.

Weekday DST begins

Options: Sunday
Monday
Tuesday
Wednesday
Thursday
Friday
Saturday

The parameter determines the weekday when daylight saving time begins.

Month DST begins

Options: January
February
March
April
May
June
July
August
September
October
November
December

The parameter determines the month when daylight saving time begins.

ABB i-bus[®] KNX Commissioning

The following parameters are displayed if *Date* is selected.

Month DST begins

Options: January
 February
 March
 April
 May
 June
 July
 August
 September
 October
 November
 December

The parameter determines the month when daylight saving time begins.

Day DST begins

Options: 1 ... (28/29/30/) 31

The parameter determines the day when daylight saving time begins.

ABB i-bus[®] KNX Commissioning

Weekday or fixed date DST ends

Options: Weekday
Date

The parameter defines whether daylight saving time should always end on a fixed weekday or on a fixed date.

The following parameters are displayed if *Weekday* is selected.

Week in month DST ends

Options: 1
2
3
4
Last

The parameter indicates the week of the month when daylight saving time ends.

Weekday DST ends

Options: Sunday
Monday
Tuesday
Wednesday
Thursday
Friday
Saturday

The parameter determines the weekday when daylight saving time ends.

Month DST ends

Options: January
February
March
April
May
June
July
August
September
October
November
December

The parameter determines the month when daylight saving time ends.

ABB i-bus[®] KNX Commissioning

The following parameters are displayed if *Date* is selected.

Month DST ends

Options: January
 February
 March
 April
 May
 June
 July
 August
 September
 October
 November
 December

The parameter determines the month when daylight saving time ends.

Day DST ends

Options: 1 ... (28/29/30/) 31

The parameter determines the day when daylight saving time ends.

3.2.3

Parameter window *GPS coordinates and sun data – GPS coordinates*

The settings for reception of the GPS coordinates are made in this parameter window. Parameters can be used to define how the values are received and whether the coordinates are to be sent on the bus.

+ Time standard	Coordinates by receiver or bus value	<input type="radio"/> Bus (external) <input checked="" type="radio"/> Receiver (internal)
- GPS coordinates and sun data	Send GPS coordinates	never
GPS coordinates		
GPS sun data		
Fault and state intervall		
+ Time switch Standard		
+ Time switch Astro		
+ Time switch Astro Plus		
+ Light		
+ Temperature		

Coordinates by receiver or bus value

Options: Receiver (internal)
Bus (external)

This parameter is used to select whether the internal GPS receiver is to be used to receive the coordinates or whether the value is to be received externally via the bus.

If the option *Bus (external)* is selected, the device can no longer send the time values received via GPS on the bus.

ABB i-bus[®] KNX Commissioning

The following parameter appears with the option *Receiver (internal)*:

Send GPS coordinates

Options: Never
 On request
 On request and automatically/cyclically

- *Never*: Sending on the bus is deactivated.
- *On request*: The 1-bit object *Bus request to send GPS coordinates – Reception* is activated. When the “On” value is received on this object, the GPS coordinates are sent on the bus via the corresponding objects.
- *On request and automatically/cyclically*: The 1-bit object *Bus request to send GPS coordinates – Reception* is activated. When the “On” value is received on this object, the GPS coordinates are sent on the bus via the corresponding objects. The dependent parameter *Cycle interval for coordinates* is additionally activated.

Cycle interval for coordinates

Options: Every 30 seconds
 Every minute
 Every hour
 Every 6 hours
 Every 12 hours
 At midnight
 At 00:02

Depending on the selection, the GPS coordinates are correspondingly sent cyclically on the bus.

3.2.4

Parameter window *GPS coordinates and sun data – GPS sun data*

All settings for the GPS sun data are made in this parameter window. This allows the sun azimuth and elevation, as well as the sunrise and sunset times, to be sent on the bus.

+ Time standard	Send sun azimuth and elevation	never
- GPS coordinates and sun data	Send sunrise/sunset times	never
GPS coordinates		
GPS sun data		
Fault and state intervall		
+ Time switch Standard		
+ Time switch Astro		
+ Time switch Astro Plus		
+ Light		
+ Temperature		

ABB i-bus[®] KNX Commissioning

Send sun azimuth and elevation

Options: Never
 On request
 On request and automatically/cyclically

This parameter can be used to decide when the current position of the sun (azimuth and elevation) is to be sent on the bus.

- *Never*: Sending on the bus is deactivated.
- *On request*: The 1-bit object *Bus request to send sun angles – Reception* is activated. When the “On” value is received on this object, the sun azimuth and elevation are sent on the bus via the corresponding objects.
- *On request and automatically/cyclically*: The 1-bit object *Bus request to send sun angles – Reception* is activated. When the “On” value is received on this object, the sun azimuth and elevation are sent on the bus via the corresponding objects. The dependent parameter *Cycle interval for coordinates* is additionally activated.

Cycle interval for azimuth and elevation

Options: Every 30 seconds
 Every minute
 Every hour
 Every 6 hours
 Every 12 hours
 At midnight
 At 00:02

Depending on the selection, the sun azimuth and elevation are correspondingly sent cyclically on the bus.

Send sunrise/sunset times

Options: Never
On request
On request and automatically/cyclically

This parameter can be used to decide when the current sunrise and sunset times are to be sent on the bus.

- *Never*: Sending on the bus is deactivated.
- *On request*: The 1-bit object *Bus request to send sun times – Reception* is activated. When the “On” value is received on this object, the current sunrise and sunset times are sent on the bus via the corresponding objects.
- *On request and automatically/cyclically*: The 1-bit object *Bus request to send sun times – Reception* is activated. When the “On” value is received on this object, the current sunrise and sunset times are sent on the bus via the corresponding objects. The dependent parameter *Cycle interval for sunrise and sunset times* is additionally activated.

Cycle interval for sunrise and sunset times

Options: Every 30 seconds
Every minute
Every hour
Every 6 hours
Every 12 hours
At midnight
At 00:02
At DST
Every hour and at DST
Every 6 hours and DST
Every 12 hours and DST
At midnight and at DST
At 00:02 and at DST

Depending on the selection, the sun elevation and azimuth are correspondingly sent cyclically on the bus.

Note

During polar nights or polar days, the sun angle values in the polar regions are fixed as follows:
→ Elevation/zenith = 0°
→ Azimuth = south azimuth in the northern hemisphere/north azimuth in the southern hemisphere

3.2.5

Parameter window *GPS coordinates and sun data – Fault and state interval*

The settings for sending the GPS reception status can be made in this parameter window.

+ Time standard	Minutes before time receiver changes to "not OK"	15
- GPS coordinates and sun data	Send GPS state	never
GPS coordinates		
GPS sun data		
Fault and state intervall		
+ Time switch Standard		
+ Time switch Astro		
+ Time switch Astro Plus		
+ Light		
+ Temperature		

Minutes before time receiver changes to "not OK"

Options: 15 ... 255

The parameter can be used to set how long the GPS receiver should wait before faulty reception is to be indicated in the device's status bit.

Send GPS state

Options: Never
On change
On change and automatically/cyclically

This parameter can be used to decide when the state of GPS reception is to be sent on the bus.

- *Never*: Sending on the bus is deactivated.
- *On change*: The 1-bit object *Sends TR/A 1.1 state (0=OK; 1= not OK)* – *Sending* is activated. The value 0 is sent on this object if the GPS signal is received correctly; the value 1 is sent on this object if there was no reception for the time parameterized in the *Send GPS state* parameter. Sending takes place only on the change between reception (0) and no reception (1).
- *On change and automatically/cyclically*: The 1-bit object *Sends TR/A 1.1 state (0=OK; 1= not OK)* – *Sending* is activated. The value 0 is sent on this object if the GPS signal is received correctly; the value 1 is sent on this object if there was no reception for the time parameterized in the *Send GPS state* parameter. Sending takes place only on the change between reception (0) and no reception (1). The dependent parameter *Cycle interval for GPS state* is additionally activated.

Cycle interval for GPS state

Options: Every 30 seconds
Every minute
Every hour
Every 6 hours
Every 12 hours
At midnight
At 00:02

Depending on the selection, the GPS state is correspondingly sent cyclically on the bus.

3.2.6

Parameter window *Time switch Standard – Settings*

The settings for the time switch Standard are made in this parameter window. A switching signal can be sent on the bus and cancelled again at a certain time with this simple (daily) time switch. This allows the exterior lighting to be switched on/off at the same time each day, for example. The first and second switching times can be enabled in this window.

+ Time standard	Time switch	<input type="radio"/> Inactive <input checked="" type="radio"/> Active
+ GPS coordinates and sun data	2nd switching time	<input checked="" type="radio"/> Inactive <input type="radio"/> Active
- Time switch Standard		
Settings		
1st switching time		
+ Time switch Astro		
+ Time switch Astro Plus		
+ Light		
+ Temperature		

Time switch

Options: Inactive
Active

The time switch is enabled with this parameter.

- *Inactive*: The time switch is deactivated.
- *Active*: The 1-bit object *Sends time switch Standard – Sending* is activated. The dependent parameter window *1st switching time* is displayed. The “On” value is sent via the object at the switch-on time parameterized there, and the “Off” value is sent at the parameterized switch-off time.

2nd switching time

Options: Inactive
Active

A second switch-on time can be set for the time switch with this parameter.

- *Inactive*: The 2nd switching time is deactivated.
- *Active*: The following parameters are displayed. The dependent parameter window *2nd switching time* is displayed. The “On” value is sent via the object at the switch-on time parameterized there, and the “Off” value is sent at the parameterized switch-off time. Overlaps with already parameterized times in the *2nd switching time* parameter window can occur.

Parameter window *Time switch Standard – 1st switching time*

The settings for the first switch-on and switch-off times of time switch Standard are made in this parameter window.

+ Time standard	1st switching time	
+ GPS coordinates and sun data	Switch on from [hour]	18
- Time switch Standard	Switch on from [minute]	0
Settings	Switch on to [hour]	6
1st switching time	Switch on to [minute]	0
+ Time switch Astro		
+ Time switch Astro Plus		
+ Light		
+ Temperature		

Switch on from [hour]

Option: 0 ... 18 ... 23

The hour at which switch-on is to occur is defined here.

Switch on from [minute]

Option: 0 ... 59

The minute at which switch-on is to occur is defined here.

Switch on to [hour]

Option: 0 ... 6 ... 23

The hour until which switch-on is to occur is defined with this parameter.

Switch on to [minute]

Option: 0 ... 59

The minute until which switch-on is to occur is defined with this parameter.

3.2.8

Parameter window *Time switch Standard – 2nd switching time*

The settings for the second switch-on and switch-off times of time switch Standard are made in this parameter window.

+ Time standard	2nd switching time	
+ GPS coordinates and sun data	Switch on from [hour]	18
- Time switch Standard	Switch on from [minute]	0
Settings	Switch on to [hour]	6
1st switching time	Switch on to [minute]	0
2nd switching time		
+ Time switch Astro		
+ Time switch Astro Plus		
+ Light		
+ Temperature		

Switch on from [hour]

Option: 0 ... 18 ... 23

The hour at which switch-on is to occur is defined with this parameter.

Switch on from [minute]

Option: 0 ... 59

The minute at which switch-on is to occur is defined here.

Switch on to [hour]

Option: 0 ... 6 ... 23

The hour until which switch-on is to occur is defined with this parameter.

Switch on to [minute]

Option: 0 ... 59

The minute until which switch-on is to occur is defined with this parameter.

Parameter window *Time switch Astro – Settings*

All settings for time switch Astro are made in this parameter window. Switching times can be activated following the sunrise and sunset times (function of an astronomical time switch). Depending on the parameterization, a value (switching bit or scene) is sent on the bus at sunrise and sunset. The sunrise and sunset times are calculated based on the GPS data (coordinates/date/time). This allows the blinds to be opened and closed at each sunrise/sunset.

+ Time standard	Astro time switch function	<input type="radio"/> Inactive <input checked="" type="radio"/> Active
+ GPS coordinates and sun data	Astro time switch application	<input type="radio"/> OFF at darkness / ON at brightness <input checked="" type="radio"/> ON at darkness / OFF at brightness
+ Time switch Standard		
- Time switch Astro	Switching bit or scene	<input type="radio"/> Switching bit <input checked="" type="radio"/> Scene
Settings	Scene number for switching on	1
	Scene number for switching off	1
+ Time switch Astro Plus		
+ Light		
+ Temperature		

Astro time switch function

Options: Inactive
Active

The time switch Astro is enabled with this parameter.

- *Inactive*: The time switch Astro is deactivated.
- *Active*: The following parameters are displayed. Depending on the reaction parameterized here, switch-on or switch-off is performed via 1 bit at sunrise (brightness) or sunset (darkness) or the selected scene number is sent.

Astro time switch application

Options: OFF at darkness / ON at brightness
 ON at darkness / OFF at brightness

- *OFF at darkness / ON at brightness*: The time switch Astro switches off at darkness and on at brightness.
- *ON at darkness / OFF at brightness*: The time switch Astro switches on at darkness and off at brightness.

Switching bit or scene

Options: Switching bit
 Scene

- *Switching bit*: The 1-bit object *Sends Astro – Sending* is enabled. The object value changes according to the reaction parameterized in the *Astro time switch application* parameter.
- *Scene*: The 1-byte object *Sends Astro scene – Sending* is enabled. The following parameters are enabled.

Scene number for switching on

Options: 1 ... 64

The scene selected here is sent on switch-on.

Scene number for switching off

Options: 1 ... 64

The scene selected here is sent on switch-off.

Parameter window *Time switch Astro Plus*

All settings for time switch Astro Plus are made in this parameter window. Switching times can be activated following the sunrise and sunset times (function of an astronomical time switch). Depending on the parameterization, a value (switching bit or scene) is sent on the bus at sunrise and sunset. An offset can also be defined for the sunrise and sunset times. Furthermore, *Extra time switch* can be used to activate an additional switch-on and/or switch-off time (e.g. nighttime economy setting) with a fixed switching duration. The sunrise and sunset times are calculated based on the GPS data (coordinates/date/time). This permits more complex switch-on/switch-off scenarios to be implemented depending on the sunrise and sunset, e.g. exterior lighting that is active only immediately prior to/after sunrise/sunset or that switches on before sunset.

+ Time standard	Astro Plus time switch function	<input type="radio"/> Inactive <input checked="" type="radio"/> Active
+ GPS coordinates and sun data	Astro Plus time switch application	<input type="radio"/> OFF at darkness / ON at brightness <input checked="" type="radio"/> ON at darkness / OFF at brightness
+ Time switch Standard		
+ Time switch Astro	Switching bit or scene	<input checked="" type="radio"/> Switching bit <input type="radio"/> Scene
- Time switch Astro Plus	Extra time switch	<input checked="" type="radio"/> Inactive <input type="radio"/> Active
Settings		
Astro time switch offset		
+ Light		
+ Temperature		

Astro Plus time switch function

Options: Inactive
Active

The time switch Astro Plus is enabled with this parameter.

- *Inactive*: The time switch Astro Plus is deactivated.
- *Active*: The following parameters are displayed. Depending on the reaction parameterized here, switch-on or switch-off is performed via 1 bit at sunrise (brightness) or sunset (darkness) or the selected scene number is sent.

Astro Plus time switch application

Options: OFF at darkness / ON at brightness
 ON at darkness / OFF at brightness

- *OFF at darkness / ON at brightness*: The time switch Astro Plus switches off at darkness and on at brightness.
- *ON at darkness / OFF at brightness*: The time switch Astro Plus switches on at darkness and off at brightness.

Switching bit or scene

Options: Switching bit
 Scene

- *Switching bit*: The 1-bit object *Sends Astro Plus – Sending* is enabled. The object value changes according to the reaction parameterized in the *Astro Plus time switch application* parameter.
- *Scene*: The 1-byte object *Sends Astro Plus scene – Sending* is enabled. The following parameters are enabled.

Scene number for switching on

Options: 1 ... 64

The scene selected here is sent on switch-on.

Scene number for switching off

Options: 1 ... 64

The scene selected here is sent on switch-off.

Extra time switch

Options: Active
 Inactive

Extra switching times for the time switch Astro Plus can be enabled with this window. It can be used to define additional switch-on and switch-off times.

- *Inactive*: The additional switching times are deactivated.
- *Active*: The dependent parameter page *Extra time switch* is enabled. The additional switch-on and switch-off times can be parameterized here.

3.2.11 **Parameter window *Time switch Astro Plus – Astro time switch offset***

The offset settings for the switching times of time switch Astro Plus can be made in this parameter window. This permits earlier or later switch-on and switch-off.

Time switch Astro Plus morning offset [minutes]

Options: -128 ... 0 ... 127

This parameter can be used to shift the morning switching time (brightness) forward (-128 ... -1) or back (1... 127) by the value parameterized here. If the value 0 is selected, no offset is set and switching takes place precisely at sunrise.

Time switch Astro Plus evening offset [minutes]

Options: -128 ... 0 ... 127

This parameter can be used to shift the evening switching time (darkness) forward (-128 ... -1) or back (1... 127) by the value parameterized here. If the value 0 is selected, no offset is set and switching takes place precisely at sunset.

3.2.12

Parameter window *Time switch Astro Plus – Extra time switch*

The settings for the extra switching times can be made in this parameter window. The window is visible only if the *Extra time switch* parameter is set to *Active* in the *Settings* parameter window.

+ Time standard	Switch OFF	<input checked="" type="radio"/> Inactive <input type="radio"/> Active
+ GPS coordinates and sun data	Switch ON	<input checked="" type="radio"/> Inactive <input type="radio"/> Active
+ Time switch Standard		
+ Time switch Astro		
- Time switch Astro Plus		
Settings		
Astro time switch offset		
Extra time switch		
+ Light		
+ Temperature		

Switch OFF

Options: Inactive
Active

An additional “Off” period can be activated for time switch Astro Plus with this parameter. An “Off” signal is additionally sent via the output object of the time switch during this period, e.g. to switch off lighting additionally during a certain period.

- *Inactive*: The additional “OFF” period is deactivated.
- *Active*: The following parameters are displayed.

Switch off from [hour]

Option: 0 ... 18 ... 23

The hour of the switch-off time is defined with this parameter. The scene value or the corresponding switching-bit value defined for "Off" will be sent at this time.

Switch off from [minute]

Option: 0 ... 59

The minute of the switch-off time is defined with this parameter. The scene value or the corresponding switching-bit value defined for "Off" will be sent at this time.

Switch off to [hour]

Option: 0 ... 5 ... 23

The hour of the switch-off time is defined with this parameter. The scene value or the corresponding switching-bit value defined for "On" will be sent at this time.

Switch off to [minute]

Option: 0 ... 59

The minute of the switch-off time is defined with this parameter. The scene value or the corresponding switching-bit value defined for "On" will be sent at this time.

Switch ON

Options: Inactive
 Active

An additional “On” period can be activated for time switch Astro Plus with this parameter. An “On” signal is additionally sent via the output object of the time switch during this period, e.g. to switch on lighting additionally during a certain period.

- *Inactive*: The additional “ON” period is deactivated.
- *Active*: The following parameters are displayed.

Switch on from [hour]

Option: 0 ... 18 ... 23

The hour of the switch-on time is defined with this parameter. The scene value or the corresponding switching-bit value defined for “On” will be sent at this time.

Switch on from [minute]

Option: 0 ... 59

The minute of the switch-on time is defined with this parameter. The scene value or the corresponding switching-bit value defined for “On” will be sent at this time.

Switch on to [hour]

Option: 0 ... 6 ... 23

The hour of the switch-on time is defined with this parameter. The scene value or the corresponding switching-bit value defined for “Off” will be sent at this time.

Switch on to [minute]

Option: 0 ... 59

The minute of the switch-on time is defined with this parameter. The scene value or the corresponding switching-bit value defined for “Off” will be sent at this time.

Parameter window *Light – Light sensor*

The settings for the light sensor are made in this parameter window. The light sensor's measurement value can be sent on the bus and/or light control can be activated (twilight switch function). Corresponding to the set parameterization, light control reacts like a twilight switch (lux threshold/hysteresis/delay) and sends a value (switching byte or scene) on the bus when the set lux threshold (+delay and hysteresis) is reached. Furthermore, *Extra time switch* can be used to activate an additional switch-on and/or switch-off time (e.g. nighttime economy setting) with a fixed switching duration.

+ Time standard	Send measurement value	never ▼
+ GPS coordinates and sun data		
+ Time switch Standard		
+ Time switch Astro		
+ Time switch Astro Plus		
- Light		
Light sensor		
Light control		
+ Temperature		

Send measurement value

- Options:
- Never
 - On request
 - On request and automatically/cyclically
 - On request and change
 - On request, change and automatically/cyclically

The parameter is used to set when the value of the internal brightness sensor is to be sent.

- *Never*: Sending on the bus is deactivated.
- *On request*: The 1-bit object *Bus request to send lux – Reception* is activated. The measured lux value is sent on the bus via the corresponding object when the “On” value is received on this object.
- *On request and automatically/cyclically*: The 1-bit object *Bus request to send lux – Reception* is activated. The measured lux value is sent on the bus via the corresponding object when the “On” value is received on this object. The dependent parameter *Sending cycle for measurement value* is additionally activated.
- *On request and change*: The 1-bit object *Bus request to send lux – Reception* is activated. The measured lux value is sent on the bus via the corresponding object when the “On” value is received on this object. The dependent parameter *Send at percentage change in measurement value* is additionally activated.
- *On request, change and automatically/cyclically*: The 1-bit object *Bus request to send lux – Reception* is activated. The measured lux value is sent on the bus via the corresponding object when the “On” value is received on this object. The dependent parameters *Sending cycle for measurement value* and *Send at percentage change in measurement value* are additionally activated.

Sending cycle for measurement value

Options: Every 30 seconds
 Every minute
 Every hour
 Every 6 hours
 Every 12 hours
 At midnight
 At 00:02

Depending on the selection, the measured lux value is correspondingly sent cyclically on the bus.

Send at percentage change in measurement value

Options: 1 ... 10 ... 50

The value set here determines the percentage change in the measurement value at which the new value is to be sent on the bus.

Parameter window *Light – Light control*

The light control settings can be made in this parameter window.

+ Time standard	Lux switching	<input type="radio"/> Inactive <input checked="" type="radio"/> Active
+ GPS coordinates and sun data	Light control depending on internal measurement or external bus value	<input type="radio"/> Bus (external) <input checked="" type="radio"/> Measurement value (internal)
+ Time switch Standard	Lux logic	<input type="radio"/> OFF at darkness / ON at brightness <input checked="" type="radio"/> ON at darkness / OFF at brightness
+ Time switch Astro	Threshold 2	<input checked="" type="radio"/> Inactive <input type="radio"/> Active
+ Time switch Astro Plus	Extra time switch	<input checked="" type="radio"/> Inactive <input type="radio"/> Active
- Light		
Light sensor		
Light control		
Threshold 1		
+ Temperature		

Lux switching

Options: Inactive
Active

This parameter is used to set whether light control is activated or deactivated.

- *Inactive*: Light control is deactivated.
- *Active*: Light control is activated. The dependent parameters
 - *Light control depending on internal measurement or external bus value*
 - *Lux logic*
 - *Threshold 2*
 - *Extra time switch*

and the dependent *Threshold 1* parameter page are displayed.

ABB i-bus[®] KNX Commissioning

Light control depending on internal measurement or external bus value

Options: Measurement value (internal)
Bus (external)

This parameter is used to select whether the internal brightness sensor is to be used to measure the brightness or whether the value is to be received externally via the bus.

- *Measurement value (internal)*: The internal measurement value is used.
- *Bus (external)*: The object *Receives light value from bus* is enabled. The current brightness value to be used for light control must be sent on this object.

Lux logic

Options: OFF at darkness / ON at brightness
ON at darkness / OFF at brightness

- *OFF at darkness / ON at brightness*: The time switch Astro switches off at darkness and on at brightness.
- *ON at darkness / OFF at brightness*: The time switch Astro switches on at darkness and off at brightness.

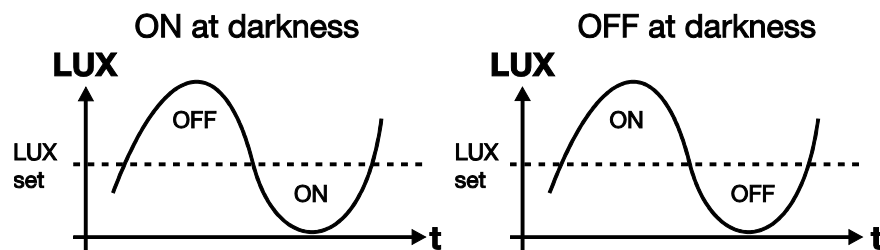

Threshold 2

Options: Inactive
Active

A second switching threshold for brightness-dependent control can be enabled with this option.

- *Inactive*: The second brightness threshold is deactivated.
- *Active*: The second brightness threshold is active. The dependent parameter page *Threshold 2* and the object *Sends light above/below threshold 2 – Sending* is enabled.

Extra time switch

Options: Active
Inactive

This parameter can be used to enable extra switching times for light control. This permits additional switch-on and switch-off points to be defined that trigger switching depending on time instead of depending on brightness.

- *Inactive*: The additional switching times are deactivated.
- *Active*: The dependent parameter page *Extra time switch* is enabled. The additional switch-on and switch-off times can be parameterized here.

3.2.14.1 Parameter window *Light – Threshold 1*

The settings for brightness control threshold 1 are made in this window. The data entered here influence the object *Sends light above/below threshold 1 – Sending*.

<ul style="list-style-type: none"> + Time standard + GPS coordinates and sun data + Time switch Standard + Time switch Astro + Time switch Astro Plus - Light <ul style="list-style-type: none"> Light sensor Light control <li style="background-color: #e0e0e0;">Threshold 1 Threshold 2 + Temperature 	<p>Threshold 1:</p> <p>Threshold in [lux] <input style="width: 100px;" type="text" value="20"/></p> <p>Hysteresis in [%] <input style="width: 100px;" type="text" value="25"/></p> <p>Delay darkness in [s] <input style="width: 100px;" type="text" value="60"/></p> <p>Delay brightness in [s] <input style="width: 100px;" type="text" value="60"/></p> <p>Switching bit or scene <input checked="" type="radio"/> Switching bit <input type="radio"/> Scene</p> <p>--> Blocking object function available in devices manufactured on or after CW16/2017</p> <p>Enable blocking object <input checked="" type="radio"/> No <input type="radio"/> Yes</p>
--	--

Threshold in [lux]

Options: 1 ... 20 ... 220,000

The switching threshold at which switchover of the object *Sends light above/below threshold 1 – Sending* is to take place is entered with this parameter.

Hysteresis in [%]

Options: 0 ... 25 ... 50

The parameter is used to define a hysteresis that must be exceeded or fallen below before the value is switched over again. This serves to prevent slight fluctuations from constantly switching the value. Setting the value 0 deactivates the hysteresis.

Delay darkness in [s]

Options: 0 ... 60 ... 3,600

The parameter is used to define a delay for falling below the parameterized threshold. Switchover takes place only after the threshold (plus hysteresis) has been fallen below for the parameterized time. This serves to prevent brief dimming from causing unnecessary switching.

Delay brightness in [s]

Options: 0 ... 60 ... 3,600

The parameter is used to define a delay for exceeding the parameterized threshold. Switchover takes place only after the threshold (plus hysteresis) has been exceeded for the parameterized time. This serves to prevent brief illumination (e.g. by car headlights) from causing unnecessary switching.

Switching bit or scene

Options: Switching bit
Scene

- *Switching bit*: The 1-bit object *Sends light above/below threshold 1 – Sending* is enabled. The object value changes according to the reaction parameterized in the *Lux logic* parameter in the *Light control* parameter window.
- *Scene*: The 1-byte object *Sends scene light above/below threshold 1 – Sending* is enabled. The following parameters are enabled.

Scene number for switching on

Options: 1 ... 64

The scene selected here is sent on switch-on.

Scene number for switching off

Options: 1 ... 64

The scene selected here is sent on switch-off.

Enable blocking object

Options: No
Yes

A 1-bit object to block brightness control can be enabled with this object. If brightness control is blocked, the output object is no longer changed until the block is canceled, even if the brightness exceeds/falls below the parameterized thresholds.

- *No*: The blocking object is deactivated.
- *Yes*: The blocking object *Light control blocking object threshold 1 – Reception* is enabled. The following dependent parameters are additionally enabled.

Evaluation of the blocking object

Options: Block on 1
Block on 0

This parameter is used to set the condition under which brightness control is blocked.

- *Block on 1*: Brightness control is blocked when a 1 is received on the input object. A 0 cancels the block again.
- *Block on 0*: Brightness control is blocked when a 0 is received on the input object. A 1 cancels the block again.

State after reset

Options: Enabled
Blocked

The parameter is used to define whether brightness control is to be blocked or enabled after an ETS reset.

- *Enabled*: Brightness control is enabled after ETS reset.
- *Blocked*: Brightness control is blocked after ETS reset.

Reaction on removing the block

Options: Send current value
 No action

The parameter defines the brightness control reaction when the block is canceled.

- *Send current value*: The currently valid brightness control value is sent.
- *No action*: The object does not send its current status automatically, but only after the next change.

Reaction on setting the block

Options: No action
 Send a telegram

The parameter defines the brightness control reaction when the block is set.

- *No action*: The object does not send anything and is blocked.
- *Send a telegram*: A telegram is sent on the bus via the object *Sends light above/below threshold 1 – Sending* or *Sends scene light above/below threshold 1 – Sending* when the block is set. The dependent parameter *Telegram on setting the block* is enabled.

Telegram on setting the block

The parameter options depend on the selected *Switching bit or scene* parameter.

The following options are available if *Switching bit* was selected:

Options: 0
 1

- *0*: The value 0 is sent.
- *1*: The value 1 is sent.

The following values are available if *scene* was selected.

Options: 1 ... 64

The selected scene number is sent on the bus when the block is activated.

3.2.14.2 Parameter window *Light – Threshold 2*

The settings for brightness control threshold 2 are made in this window. The data entered here influence the object *Sends light above/below threshold 2 – Sending*.

<ul style="list-style-type: none"> + Time standard + GPS coordinates and sun data + Time switch Standard + Time switch Astro + Time switch Astro Plus - Light <ul style="list-style-type: none"> Light sensor Light control Threshold 1 <li style="background-color: #e0e0e0;">Threshold 2 + Temperature 	<p>Threshold 2:</p> <p>Threshold in [Lux] <input style="width: 100px;" type="text" value="20"/></p> <p>Hysteresis in [%] <input style="width: 100px;" type="text" value="25"/></p> <p>Delay darkness in [s] <input style="width: 100px;" type="text" value="60"/></p> <p>Delay brightness in [s] <input style="width: 100px;" type="text" value="60"/></p> <p>Switching bit or scene <input checked="" type="radio"/> Switching bit <input type="radio"/> Scene</p> <p>--> Blocking object function available in devices manufactured on or after CW16/2017</p> <p>Enable blocking object <input checked="" type="radio"/> No <input type="radio"/> Yes</p>
--	--

Threshold in [lux]

Options: 1 ... 20 ... 220,000

The switching threshold at which the object *Sends light above/below threshold 2 – Sending* is to be switched is sent with this parameter.

Hysteresis in [%]

Options: 0 ... 25 ... 50

The parameter is used to define a hysteresis that must be exceeded or fallen below before the value is switched over again. This serves to prevent slight fluctuations from constantly switching the value. Setting the value 0 deactivates the hysteresis.

Delay darkness in [s]

Options: 0 ... 60 ... 3,600

The parameter is used to define a delay for falling below the parameterized threshold. Switchover takes place only after the threshold (plus hysteresis) has been fallen below for the parameterized time. This serves to prevent brief dimming of the light from causing unnecessary switching.

Delay brightness in [s]

Options: 0 ... 60 ... 3,600

The parameter is used to define a delay for exceeding the parameterized threshold. Switchover takes place only after the threshold (plus hysteresis) has been exceeded for the parameterized time. This serves to prevent brief illumination (e.g. by car headlights) from causing unnecessary switching.

Switching bit or scene

Options: Switching bit
Scene

- *Switching bit*: The 1-bit object *Sends light above/below threshold 2 – Sending* is enabled. The object value changes according to the reaction parameterized in the *Lux logic* parameter in the *Light control* parameter window.
- *Scene*: The 1-byte object *Sends scene light above/below threshold 2 – Sending* is enabled. The following parameters are enabled.

Scene number for switching on

Options: 1 ... 64

The scene selected here is sent on switch-on.

Scene number for switching off

Options: 1 ... 64

The scene selected here is sent on switch-off.

Enable blocking object

Options: No
Yes

A 1-bit object to block brightness control can be enabled with this object. If brightness control is blocked, the output object is no longer changed until the block is canceled, even if the brightness exceeds/falls below the parameterized thresholds.

- *No*: The blocking object is deactivated.
- *Yes*: The blocking object *Light control blocking object threshold 2 – Reception* is enabled. The following dependent parameters are additionally enabled.

Evaluation of the blocking object

Options: Block on 1
Block on 0

This parameter is used to set the condition under which brightness control is blocked.

- *Block on 1*: Brightness control is blocked when a 1 is received on the input object. A 0 cancels the block again.
- *Block on 0*: Brightness control is blocked when a 0 is received on the input object. A 1 cancels the block again.

State after reset

Options: Enabled
Blocked

The parameter is used to define whether brightness control is to be blocked or enabled after an ETS reset.

- *Enabled*: Brightness control is enabled after ETS reset.
- *Blocked*: Brightness control is blocked after ETS reset.

Reaction on removing the block

Options: Send current value
 No action

The parameter defines the brightness control reaction when the block is canceled.

- *Send current value*: The currently valid brightness control value is sent.
- *No action*: The object does not send its current status automatically, but only after the next change.

Reaction on setting the block

Options: No action
 Send a telegram

The parameter defines the brightness control reaction when the block is set.

- *No action*: The object sends nothing and is blocked.
- *Send a telegram*: A telegram is sent on the bus via the object *Sends light above/below threshold 2 – Sending* or *Sends scene light above/below threshold 2 – Sending* when the block is set. The dependent parameter *Telegram on setting the block* is enabled.

Telegram on setting the block

The parameter options depend on the selected *Switching bit or scene* parameter.

The following options are available if *Switching bit* was selected:

Options: 0
 1

- *0*: The value 0 is sent
- *1*: The value 1 is sent

The following values are available if *scene* was selected.

Options: 1 ... 64

The selected scene number is sent on the bus when the block is activated.

3.2.14.3 Parameter window *Light – Extra time switch*

The settings for the extra switching times can be made in this parameter window. The window is visible only when the *Extra time switch* parameter is set to *Active* in the *Light control* parameter window. The extra switching times affect both threshold objects (*Sends light above/below threshold 1 – Sending* and *Sends light above/below threshold 2 – Sending*).

+ Time standard	Switch OFF	<input checked="" type="radio"/> Inactive <input type="radio"/> Active
+ GPS coordinates and sun data	Switch ON	<input checked="" type="radio"/> Inactive <input type="radio"/> Active
+ Time switch Standard		
+ Time switch Astro		
+ Time switch Astro Plus		
- Light		
Light sensor		
Light control		
Threshold 1		
Threshold 2		
Extra time switch		
+ Temperature		

Switch OFF

Options: Inactive
Active

An additional “Off” period can be activated for brightness control with this parameter. An “Off” signal is additionally sent via the output object of the time switch during this period, e.g. to switch off lighting additionally during a certain period.

- *Inactive*: The additional “OFF” period is deactivated.
- *Active*: The following parameters are displayed.

Switch off from [hour]

Option: 0 ... 18 ... 23

The hour of the switch-off time is defined with this parameter. The scene value or the corresponding switching-bit value defined for "Off" will be sent at this time.

Switch off from [minute]

Option: 0 ... 59

The minute of the switch-off time is defined with this parameter. The scene value or the corresponding switching-bit value defined for "Off" will be sent at this time.

Switch off to [hour]

Option: 0 ... 5 ... 23

The hour of the switch-off time is defined with this parameter. The scene value or the corresponding switching-bit value defined for "On" will be sent at this time.

Switch off to [minute]

Option: 0 ... 59

The minute of the switch-off time is defined with this parameter. The scene value or the corresponding switching-bit value defined for "On" will be sent at this time.

Switch ON

Options: Inactive
 Active

An additional “On” period can be activated for time switch Astro Plus with this parameter. An “On” signal is additionally sent via the output object of the time switch during this period, e.g. to switch on lighting additionally during a certain period.

- *Inactive*: The additional “ON” period is deactivated.
- *Active*: The following parameters are displayed.

Switch on from [hour]

Option: 0 ... 18 ... 23

The hour of the switch-on time is defined with this parameter. The scene value or the corresponding switching-bit value defined for “On” will be sent at this time.

Switch on from [minute]

Option: 0 ... 59

The minute of the switch-on time is defined with this parameter. The scene value or the corresponding switching-bit value defined for “On” will be sent at this time.

Switch on to [hour]

Option: 0 ... 6 ... 23

The hour of the switch-on time is defined with this parameter. The scene value or the corresponding switching-bit value defined for “Off” will be sent at this time.

Switch on to [minute]

Option: 0 ... 59

The minute of the switch-on time is defined with this parameter. The scene value or the corresponding switching-bit value defined for “Off” will be sent at this time.

Parameter window *Temperature –Temperature sensor*

The parameter window is used to make the settings for the integrated temperature sensor. The temperature sensor can be used to put the outside temperature on the KNX bus.

+ Time standard	Send measurement value	never
+ GPS coordinates and sun data		
+ Time switch Standard		
+ Time switch Astro		
+ Time switch Astro Plus		
+ Light		
- Temperature		
Temperature sensor		
Temperature control		

Send measurement value

- Options: Never
On request
On request and automatically/cyclically
On request and change
On request, change and automatically/cyclically

The parameter is used to set when the value of the internal temperature sensor is to be sent.

- *Never*: Sending on the bus is deactivated.
- *On request*: The 1-bit object *Bus request to send temperature – Reception* is activated. The measured temperature is sent on the bus via the corresponding object when the “On” value is received on this object.
- *On request and automatically/cyclically*: The 1-bit object *Bus request to send temperature – Reception* is activated. The measured temperature value is sent on the bus via the corresponding object when the “On” value is received on this object. The dependent parameter *Sending cycle for measurement value* is additionally activated.
- *On request and change*: The 1-bit object *Bus request to send temperature – Reception* is activated. The measured temperature value is sent on the bus via the corresponding object when the “On” value is received on this object. The dependent parameter *Send on measurement value change in [0.1°C]* is additionally activated.
- *On request, change and automatically/cyclically*: The 1-bit object *Bus request to send temperature – Reception* is activated. The measured temperature is sent on the bus via the corresponding object when the “On” value is received on this object. The dependent parameters *Sending cycle for measurement value* and *Send on measurement value change in [0.1°C]* are additionally activated.

Sending cycle for measurement value

Options: Every 30 seconds
 Every minute
 Every hour
 Every 6 hours
 Every 12 hours
 At midnight
 At 00:02

Depending on the selection, the measured temperature value is correspondingly set cyclically on the bus.

Send on measurement value change in [0.1°C]

Options: 1 ... 10 ... 255

The value set here determines the change in the measurement value at which the new value is to be sent on the bus. The value is specified in increments of 0.1 °C; entering the value 10 causes the measurement value to be sent each time it changes by 1 °C.

Parameter window *Temperature –Temperature control*

The parameter window is used to make the temperature control settings. Simple (outside) temperature-dependent control can be implemented with temperature control. The measured temperature is compared with a pre-parameterized threshold here, and the output object is switched over correspondingly. A 1-bit switching object or a 1-byte scene object is available as the output object here. They can be used to decide whether to switch the heater on or off, for example.

+ Time standard	Temperature threshold	<input type="radio"/> Inactive <input checked="" type="radio"/> Active
+ GPS coordinates and sun data	Temperature control depending on internal measurement or external bus value	<input type="radio"/> Bus (external) <input checked="" type="radio"/> Measurement value (internal)
+ Time switch Standard	Temperature setpoint in [0.1°C]	200
+ Time switch Astro	Temperature hysteresis [0.1°C]	10
+ Time switch Astro Plus	Delay temperature setpoint in [s]	60
+ Light	Temperature logic	<input checked="" type="radio"/> T < setpoint (heating) <input type="radio"/> T > setpoint (cooling)
- Temperature	Switching bit or scene	<input checked="" type="radio"/> Switching bit <input type="radio"/> Scene
Temperature sensor	--> Blocking object function available in devices manufactured on or after CW16/2017	
Temperature control	Enable blocking object	<input checked="" type="radio"/> No <input type="radio"/> Yes

Temperature threshold

Options: Inactive
Active

- *Inactive*: Temperature control is deactivated.
- *Active*: Temperature control is activated. The following dependent parameters and the dependent object *Sends temperature above/below setpoint temperature – Sending* are displayed.

Temperature control depending on internal measurement or external bus value

Options: Measurement value (internal)
 Bus (external)

This parameter is used to select whether the internal temperature sensor is to be used for temperature control or whether the value is to be received externally via the bus.

- *Measurement value (internal)*: The internal measurement value is used.
- *Bus (external)*: The object *Receives temperature from bus* is enabled. The current temperature value to be used for temperature control must be sent on this object.

Temperature setpoint in [0.1°C]

Options: - 500 ... 200 ... 1,000

This parameter is used to define the setpoint temperature to be used for temperature control.

Temperature hysteresis [0.1°C]

Options: 1 ... 10 ... 600

The parameter can be used to set a hysteresis on either side of the temperature setpoint. The hysteresis is added to/subtracted from the setpoint and is used to compensate for possible fluctuations in the measurement value. This prevents values that briefly exceed the setpoint temperature and fall below it again from leading to constant changes in the output object states.

The hysteresis causes switchover to take place only when the setpoint is exceeded by the value (setpoint + hysteresis) set in this parameter. Conversely, switchover when the value falls below the setpoint occurs only when the value falls below the threshold minus the value set here (setpoint – hysteresis).

Delay temperature setpoint in [s]

Options: 0 ... 60 ... 3,600

A delay for evaluating the actual temperature with the setpoint temperature can be set in this parameter. This permits compensation for brief fluctuations, e.g. when the sun appears briefly through the cloud cover on a heavily overcast day. The time set here leads to switchover occurring only when the outside value is above/below the setpoint for the set time.

Temperature logic

Options: $\frac{T < \text{setpoint (heating)}}{T > \text{setpoint (cooling)}}$

The temperature control function is set with this parameter. Depending on the selection, the output object *Sends temperature above/below setpoint temperature – Sending* is switched from 0 to 1 when the value exceeds the setpoint temperature ($T < \text{setpoint (heating)}$) or falls below the setpoint temperature ($T > \text{setpoint (cooling)}$). The switch-on/switch-off value is sent analogously if a scene object instead of a switching bit is used as the output object.

The measured temperature (or the temperature received via the object) is constantly compared with the setpoint to determine the switchover time.



ABB i-bus[®] KNX Commissioning

Switching bit or scene

Options: Switching bit
 Scene

- *Switching bit*: The 1-bit object *Sends temperature above/below setpoint temperature – Sending* is enabled. The object value changes according to the reaction parameterized in the *Temperature logic* parameter.
- *Scene*: The 1-byte object *Sends scene temperature above/below setpoint temperature – Sending* is enabled. The following parameters are enabled.

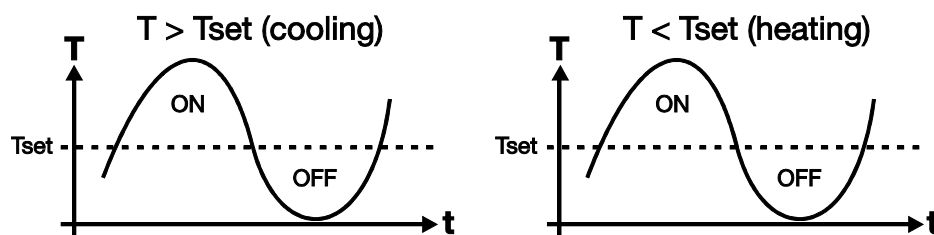
Scene number for switching on

Options: 1 ... 64

The scene selected here is sent on switch-on.

Scene number for switching off

Options: 1 ... 64

The scene selected here is sent on switch-off.

Enable blocking object

Options: No
Yes

A 1-bit object to block temperature control can be enabled with this object. If temperature control is blocked, the output object is no longer changed until the block is canceled, even if the temperature exceeds/falls below the parameterized setpoint temperature.

- *No*: The blocking object is deactivated.
- *Yes*: The blocking object *Temperature control blocking object – Reception* is enabled. The following dependent parameters are additionally enabled.

Evaluation of the blocking object

Options: Block on 1
Block on 0

This parameter is used to set the condition under which temperature control is blocked.

- *Block on 1*: Temperature control is blocked when a 1 is received on the input object. A 0 cancels the block again.
- *Block on 0*: Temperature control is blocked when a 0 is received on the input object. A 1 cancels the block again.

State after reset

Options: Enabled
Blocked

The parameter is used to define whether temperature control is to be blocked or enabled after an ETS reset.

- *Enabled*: Temperature control is enabled after ETS reset.
- *Blocked*: Temperature control is blocked after ETS reset.

Reaction on removing the block

Options: Send current value
 No action

The parameter defines the temperature control reaction when the block is canceled.

- *Send current value*: The currently valid temperature control value is sent.
- *No action*: The object does not send its current status automatically, but only after the next change.

Reaction on setting the block

Options: No action
 Send a telegram

The parameter defines the temperature control reaction when the block is set.

- *No action*: The object does not send anything and is blocked.
- *Send a telegram*: A telegram is sent on the bus via the object *Sends temperature above/below setpoint temperature – Sending* or *Sends scene temperature above/below setpoint temperature – Sending* when the block is set. The dependent parameter *Telegram on setting the block* is enabled.

Telegram on setting the block

The parameter options depend on the selected *Switching bit* or *Scene* parameter.

The following options are available if *Switching bit* was selected:

Options: 0
 1

- *0*: The value 0 is sent.
- *1*: The value 1 is sent.

The following values are available if *Scene* was selected:

Options: 1 ... 64

The selected scene number is sent on the bus when the block is activated.

3.3 Group objects

Note
As standard, the write flag (with the exception of 1-bit group objects) is deleted with the group object values. Thus the group object value cannot be changed via the bus. If this function is required, the write flag must be set in ETS.
The group object value is overwritten with the parameterized value after bus voltage recovery.

3.3.1 Summary of group objects

GO No.	Function	Name	Data Point Type (DPT)	Length	Flags				
					C	R	W	T	U
0	Sending	Sends the current date on the bus	11.001	3 bytes	x				x
1	Sending	Sends the current time on the bus	10.001	3 bytes	x				x
2	Not assigned								
3	Reception	Bus request to send date and time	1.017	1 bit	x		x		
4	Sending	Sends the state of the TR/A 1.1	1.005	1 bit	x				x
5	Sending	Sends DST change announcement	1.00.2	1 bit	x				x
6	Sending	Sends the longitude on the bus	14.007	4 bytes	x				x
7	Sending	Sends the latitude on the bus	14.007	4 bytes	x				x
8	Reception	Bus request to send GPS coordinates	1.017	1 bit	x		x		
9	Sending	Sends sun azimuth	14.007	4 bytes	x				x
10	Sending	Sends sun azimuth	9.xxx	2 bytes	x				x
11, 12	Not assigned								
13	Sending	Sends sun elevation, 4-byte	14.007	4 bytes	x				x
14	Sending	Sends sun elevation, 2-byte	9.xxx	2 bytes	x				x
15	Reception	Bus request to send sun angles	1.017	1 bit	x		x		
16	Sending	Sends the sunrise time on the bus	10.001	3 bytes	x				x
17	Sending	Sends the sunset time on the bus	10.001	3 bytes	x				x
18	Reception	Bus request to send sun times	1.017	1 bit	x		x		
19	Sending	Sends the temperature on the bus	9.001	2 bytes	x				x
20	Sending	Sends the light value on the bus	9.004	2 bytes	x				x

ABB i-bus[®] KNX Commissioning

GO No.	Function	Name	Data Point Type (DPT)	Length	Flags				
					C	R	W	T	U
21	Reception	Bus request to send the temperature	1.017	1 bit	x		x		
22	Reception	Bus request to send the light value	1.017	1 bit	x		x		
23	Sending	Sends Astro	1.001	1 bit	x			x	
24	Sending	Sends light above/below threshold 1	1.001	1 bit	x			x	
25	Sending	Sends light above/below threshold 2	1.001	1 bit	x			x	
26	Sending	Sends temperature above/below setpoint temperature	1.001	1 bit	x			x	
27	Sending	Sends scene light above/below threshold 1	17.001	1 byte	x			x	
28	Sending	Sends scene light above/below threshold 2	17.001	1 byte	x			x	
29	Sending	Sends scene temperature above/below setpoint temperature	17.001	1 byte	x			x	
30	Sending	Sends Astro Plus scene	17.001	1 byte	x			x	
31	Sending	Sends Astro scene	17.001	1 byte	x			x	
32	Sending	Sends Astro Plus	1.001	1 bit	x			x	
33	Sending	Sends time switch Standard	1.001	1 bit	x			x	
34	Reception	Receives date from bus	11.001	3 bytes	x		x		
35	Reception	Receives time from bus	10.001	3 bytes	x		x		
36	Reception	Receives temperature from bus	9.001	2 bytes	x		x		
37	Reception	Receives light value (lux) from bus	9.004	2 bytes	x		x		
38	Reception	Receives latitude from bus	14.007	4 bytes	x		x		
39	Reception	Receives longitude from bus	14.007	4 bytes	x		x		
40	Reception	Light control blocking object threshold 1	1.003	1 bit	x		x		
41	Reception	Light control blocking object threshold 2	1.003	1 bit	x		x		
42	Reception	Temperature control blocking object	1.003	1 bit	x		x		

General group objects

No.	Function	Object name	Data type	Flags
0	Sending	Sends the current date on the bus – Sending	3-byte DPT 11.001	C, T
<p>The group object is enabled if the <i>Send date and time</i> parameter is set to <i>On request</i> or <i>On request and automatically/cyclically</i> in the <i>Time standard – Date/Time</i> parameter window. The object is used to send the current date on the bus.</p>				
1	Sending	Sends the current time on the bus – Sending	3-byte DPT 10.001	C, T
<p>The group object is enabled if the <i>Send date and time</i> parameter is set to <i>On request</i> or <i>On request and automatically/cyclically</i> in the <i>Time standard – Date/Time</i> parameter window. The object is used to send the current time on the bus.</p>				
2	Not assigned			
3	Reception	Bus request to send date and time – Reception	1-bit DPT 1.017	C, W
<p>The group object is enabled if the <i>Send date and time</i> parameter is set to <i>On request</i> or <i>On request and automatically/cyclically</i> in the <i>Time standard – Date/Time</i> parameter window. This object is used to trigger sending of the current time and date on the bus.</p>				
4	Sending	Sends the TR/A 1.1 state (0=Ok, 1=not OK) – Sending	1-bit DPT 1.005	C, T
<p>The group object is enabled if the <i>Send GPS state</i> parameter is set to <i>On request</i> or <i>On request and automatically/cyclically</i> in the <i>GPS coordinates and sun data – Fault and state interval</i> parameter window. The object is used to send the status of GPS reception on the KNX bus The duration after non-reception at which the object value changes can be set via a parameter.</p> <p>Telegram value: 0 = OK (receiving GPS signal) 1 = not OK (not receiving GPS signal)</p> <p>The device can also be checked for proper function by cyclically sending this object.</p>				
5	Sending	Sends DST announcement, 1=daylight saving time, 0=standard time – Sending	1 bit DPT 1.002	C, T
<p>This group object is always enabled. The object is used to indicate whether daylight saving time or standard time is in effect and to indicate the change between the two. The object is sent when a change between daylight saving time and standard time occurs.</p> <p>Telegram value: 0 = Standard time 1 = Daylight saving time</p>				

ABB i-bus[®] KNX Commissioning

6	Sending	Sends the longitude on the bus – Sending	4-byte DPT 14.007	C, T		
<p>The group object is enabled if the <i>Send GPS coordinates</i> parameter is set to <i>On request</i> or <i>On request and automatically/cyclically</i> in the <i>GPS coordinates and sun data – GPS coordinates</i> parameter window. The object is used to send the longitude received with the GPS receiver on the KNX bus.</p>						
7	Sending	Sends the latitude on the bus – Sending	4-byte DPT 14.007	C, T		
<p>The group object is enabled if the <i>Send GPS coordinates</i> parameter is set to <i>On request</i> or <i>On request and automatically/cyclically</i> in the <i>GPS coordinates and sun data – GPS coordinates</i> parameter window. The object is used to send the latitude received with the GPS receiver on the KNX bus.</p>						
8	Reception	Bus request to send GPS coordinates – Reception	1-bit DPT 1.017	C, W		
<p>The group object is enabled if the <i>Send GPS coordinates</i> parameter is set to <i>On request</i> or <i>On request and automatically/cyclically</i> in the <i>GPS coordinates and sun data – GPS coordinates</i> parameter window. The object is used to trigger sending of the longitude and latitude on the bus.</p>						
9	Sending	Sends sun azimuth (east=90°, south =180°) 4-byte – Sending	4-byte DPT 14.007	C, T		
<p>The group object is enabled if the <i>Send sun azimuth and elevation</i> parameter is set to <i>On request</i> or <i>On request and automatically/cyclically</i> in the <i>GPS coordinates and sun data – GPS sun data</i> parameter window. The object is used to send the current sun azimuth on the KNX bus. The azimuth can also be sent as a 2-byte value via object 10 if the receiving device can process it.</p>						
<table border="1" style="width: 100%; border-collapse: collapse;"> <tr> <td style="background-color: #e0e0e0; padding: 2px;">Note</td> </tr> <tr> <td style="padding: 2px;"> <p>During polar nights or polar days, the sun angle values in the polar regions are fixed as follows: → Elevation/zenith = 0° → Azimuth = south azimuth in the northern hemisphere/north azimuth in the southern hemisphere</p> </td> </tr> </table>					Note	<p>During polar nights or polar days, the sun angle values in the polar regions are fixed as follows: → Elevation/zenith = 0° → Azimuth = south azimuth in the northern hemisphere/north azimuth in the southern hemisphere</p>
Note						
<p>During polar nights or polar days, the sun angle values in the polar regions are fixed as follows: → Elevation/zenith = 0° → Azimuth = south azimuth in the northern hemisphere/north azimuth in the southern hemisphere</p>						

ABB i-bus[®] KNX Commissioning

10	Sending	Sends sun azimuth (east=90°, south =180°) 2-byte – Sending	2-byte DPT 9.xxx	C, T
<p>The group object is enabled if the <i>Send sun azimuth and elevation</i> parameter is set to <i>On request</i> or <i>On request and automatically/cyclically</i> in the <i>GPS coordinates and sun data – GPS sun data</i> parameter window.</p> <p>The object is used to send the current sun azimuth on the KNX bus.</p> <p>The azimuth can also be sent as a 4-byte value via object 9 if the receiving device can process it.</p> <div data-bbox="347 501 1414 658" style="border: 1px solid black; padding: 5px;"> <p>Note</p> <p>During polar nights or polar days, the sun angle values in the polar regions are fixed as follows:</p> <ul style="list-style-type: none"> → Elevation/zenith = 0° → Azimuth = south azimuth in the northern hemisphere/north azimuth in the southern hemisphere </div>				
11; 12	Not assigned			
13	Sending	Sends sun elevation, 4-byte – Sending	4-byte DPT 14.007	C, T
<p>The group object is enabled if the <i>Send sun azimuth and elevation</i> parameter is set to <i>On request</i> or <i>On request and automatically/cyclically</i> in the <i>GPS coordinates and sun data – GPS sun data</i> parameter window.</p> <p>The object is used to send the current sun elevation on the KNX bus.</p> <p>The azimuth can also be sent as a 2-byte value via object 14 if the receiving device can process it.</p> <div data-bbox="347 987 1414 1144" style="border: 1px solid black; padding: 5px;"> <p>Note</p> <p>During polar nights or polar days, the sun angle values in the polar regions are fixed as follows:</p> <ul style="list-style-type: none"> → Elevation/zenith = 0° → Azimuth = south azimuth in the northern hemisphere/north azimuth in the southern hemisphere </div>				

ABB i-bus[®] KNX Commissioning

14	Sending	Sends sun elevation, 2-byte – Sending	2-byte DPT 9.xxx	C, T										
<p>The group object is enabled if the <i>Send sun azimuth and elevation</i> parameter is set to <i>On request</i> or <i>On request and automatically/cyclically</i> in the <i>GPS coordinates and sun data – GPS sun data</i> parameter window.</p> <p>The object is used to send the current sun elevation on the KNX bus.</p> <p>The azimuth can also be sent as a 4-byte value via object 13 if the receiving device can process it.</p>														
<table border="1"> <tr> <td colspan="5">Note</td> </tr> <tr> <td colspan="5"> <p>During polar nights or polar days, the sun angle values in the polar regions are fixed as follows:</p> <p>→ Elevation/zenith = 0°</p> <p>→ Azimuth = south azimuth in the northern hemisphere/north azimuth in the southern hemisphere</p> </td> </tr> </table>					Note					<p>During polar nights or polar days, the sun angle values in the polar regions are fixed as follows:</p> <p>→ Elevation/zenith = 0°</p> <p>→ Azimuth = south azimuth in the northern hemisphere/north azimuth in the southern hemisphere</p>				
Note														
<p>During polar nights or polar days, the sun angle values in the polar regions are fixed as follows:</p> <p>→ Elevation/zenith = 0°</p> <p>→ Azimuth = south azimuth in the northern hemisphere/north azimuth in the southern hemisphere</p>														
15	Reception	Bus request to send sun angles – Reception	1-bit DPT 1.017	C, W										
<p>The group object is enabled if the <i>Send sun azimuth and elevation</i> parameter is set to <i>On request</i> or <i>On request and automatically/cyclically</i> in the <i>GPS coordinates and sun data – GPS sun data</i> parameter window.</p> <p>The object is used to trigger sending of the sun azimuth and elevation on the bus.</p>														
16	Sending	Sends the sunrise time on the bus – Sending	3-byte DPT 10.001	C, T										
<p>The group object is enabled if the <i>Send sunrise and sunset times</i> parameter is set to <i>On request</i> or <i>On request and automatically/cyclically</i> in the <i>GPS coordinates and sun data – GPS sun data</i> parameter window.</p> <p>The object is used to send the current sunrise time on the KNX bus.</p>														
17	Sending	Sends the sunset time on the bus – Sending	3-byte DPT 10.001	C, T										
<p>The group object is enabled if the <i>Send sunrise and sunset times</i> parameter is set to <i>On request</i> or <i>On request and automatically/cyclically</i> in the <i>GPS coordinates and sun data – GPS sun data</i> parameter window.</p> <p>The object is used to send the current sunset time on the KNX bus.</p>														

18	Reception	Bus request to send sun times – Reception	1-bit DPT 1.017	C, W
<p>The group object is enabled if the <i>Send sunrise and sunset times</i> parameter is set to <i>On request</i> or <i>On request and automatically/cyclically</i> in the <i>GPS coordinates and sun data – GPS sun data</i> parameter window.</p> <p>The object is used to trigger sending of the sunrise and sunset times on the bus.</p>				
19	Sending	Sends the temperature on the bus – Sending	2-byte DPT 9.001	C, T
<p>The group object is enabled if the <i>Send measurement value</i> parameter is set to <i>On request</i>, <i>On request and automatically/cyclically</i>, <i>On request and change</i> or <i>On request, change and automatically/cyclically</i> in the <i>Temperature – Temperature sensor</i> parameter window.</p> <p>The object is used to send the current outside temperature measured by the temperature sensor on the KNX bus.</p>				
20	Sending	Sends the light value on the bus – Sending	2-byte DPT 9.004	C, T
<p>The group object is enabled if the <i>Send measurement value</i> parameter is set to <i>On request</i>, <i>On request and automatically/cyclically</i>, <i>On request and change</i> or <i>On request, change and automatically/cyclically</i> in the <i>Light – Light sensor</i> parameter window.</p> <p>The object is used to send the current brightness value measured by the brightness sensor on the KNX bus.</p>				
21	Reception	Bus request to send the temperature – Reception	1-bit DPT 1.017	C, W
<p>The group object is enabled if the <i>Send measurement value</i> parameter is set to <i>On request</i>, <i>On request and automatically/cyclically</i>, <i>On request and change</i> or <i>On request, change and automatically/cyclically</i> in the <i>Temperature – Temperature sensor</i> parameter window.</p> <p>The object is used to trigger sending of the current temperature value on the bus.</p>				
22	Reception	Bus request to send the lux value – Reception	1-bit DPT 1.017	C, W
<p>The group object is enabled if the <i>Send measurement value</i> parameter is set to <i>On request</i>, <i>On request and automatically/cyclically</i>, <i>On request and change</i> or <i>On request, change and automatically/cyclically</i> in the <i>Light – Light sensor</i> parameter window.</p> <p>The object is used to trigger sending of the current brightness value on the bus.</p>				

ABB i-bus[®] KNX Commissioning

23	Sending	Sends Astro – Sending	1-bit DPT 1.001	C, W
<p>The group object is enabled if the <i>Switching bit or scene</i> parameter is set to <i>Switching bit</i> in the <i>Time switch Astro – Settings</i> parameter window.</p> <p>The object sends its value depending on the set application function for sending on the KNX bus on brightness or darkness. The object value depends on the <i>Time switch Astro application</i> parameter.</p> <p>Telegram value: 0 = Darkness/brightness 1 = Brightness/darkness</p>				
24	Sending	Sends light above/below threshold 1 – Sending	1-bit DPT 1.001	C, W
<p>The group object is enabled if the <i>Switching bit or scene</i> parameter is set to <i>Switching bit</i> in the <i>Light – Threshold 1</i> parameter window.</p> <p>The object sends its value when the values set on the <i>Light – Threshold 1</i> parameter page are exceeded/fallen below.</p> <p>Telegram value: 0 = Light below threshold 1 = Light above threshold</p>				
25	Sending	Sends light above/below threshold 2 – Sending	1-bit DPT 1.001	C, T
<p>The group object is enabled if the <i>Switching bit or scene</i> parameter is set to <i>Switching bit</i> in the <i>Light – Threshold 2</i> parameter window.</p> <p>The object sends its value when the values set on the <i>Light – Threshold 2</i> parameter page are exceeded/fallen below.</p> <p>Telegram value: 0 = Light below threshold 1 = Light above threshold</p>				
26	Sending	Sends temperature above/below setpoint	1-bit DPT 1.001	C, T
<p>The group object is enabled if the <i>Switching bit or scene</i> parameter is set to <i>Switching bit</i> in the <i>Temperature – Temperature control</i> parameter window.</p> <p>The object sends its value when the setpoint temperature set on the <i>Temperature – Temperature control</i> parameter page.</p> <p>Telegram value: 0 = Temperature below setpoint temperature 1 = Temperature above setpoint temperature</p>				
27	Sending	Sends scene light above/below threshold 1 – Sending	1-byte DPT 17.001	C, T
<p>The group object is enabled if the <i>Switching bit or scene</i> parameter is set to <i>Scene</i> in the <i>Light – Threshold 1</i> parameter window.</p> <p>The object sends the value parameterized for exceeding the threshold when the threshold is exceeded and the value parameterized for falling below the threshold when the threshold is fallen below.</p> <p>Telegram value: 0..64 = Scene number</p>				

28	Sending	Sends scene light above/below threshold 2 – Sending	1-bit DPT 17.001	C, T
<p>The group object is enabled if the <i>Switching bit or scene</i> parameter is set to <i>Scene</i> in the <i>Light – Threshold 2</i> parameter window.</p> <p>The object sends the value parameterized for exceeding the threshold when the threshold is exceeded and the value parameterized for falling below the threshold when the threshold is fallen below.</p> <p>Telegram value: 0...64 = Scene number</p>				
29	Sending	Sends scene temperature above/below setpoint temperature – Sending	1-bit DPT 17.001	C, T
<p>The group object is enabled if the <i>Switching bit or scene</i> parameter is set to <i>Scene</i> in the <i>Temperature – Temperature control</i> parameter window.</p> <p>The object sends the value parameterized for exceeding the threshold when the setpoint temperature is exceeded and the value parameterized for falling below the threshold when the setpoint temperature is fallen below.</p> <p>Telegram value: 0...64 = Scene number</p>				
30	Sending	Sends Astro Plus scene – Sending	1-bit DPT 17.001	C, T
<p>The group object is enabled if the <i>Switching bit or scene</i> parameter is set to <i>Scene</i> in the <i>Time switch Astro Plus – Settings</i> parameter window.</p> <p>The object sends its value depending on the set application function for sending on the KNX bus on brightness or darkness. The object value depends on the <i>Time switch Astro Plus</i> application parameter.</p> <p>Telegram value: 0...64 = Scene number</p>				
31	Sending	Sends Astro scene – Sending	1-bit DPT 17.001	C, T
<p>The group object is enabled if the <i>Switching bit or scene</i> parameter is set to <i>Scene</i> in the <i>Time switch Astro – Settings</i> parameter window.</p> <p>The object sends its value depending on the set application function for sending on the KNX bus on brightness or darkness. The object value depends on the <i>Time switch Astro</i> application parameter.</p> <p>Telegram value: 0...64 = Scene number</p>				

ABB i-bus[®] KNX Commissioning

32	Sending	Sends Astro Plus – Sending	1-bit DPT 1.001	C, T
<p>The group object is enabled if the <i>Switching bit or scene</i> parameter is set to <i>Switching bit</i> in the <i>Time switch Astro Plus – Settings</i> parameter window.</p> <p>The object sends its value depending on the set application function for sending on the KNX bus on brightness or darkness. The object value depends on the <i>Time switch Astro Plus</i> application parameter.</p> <p>Telegram value: 0 = Darkness/brightness 1 = Brightness/darkness</p>				
33	Sending	Sends time switch Standard – Sending	1-bit DPT 1.001	C, T
<p>The group object is enabled if the <i>Time switch</i> parameter is set to <i>Active</i> in the <i>Time switch Standard – Settings</i> parameter window.</p> <p>Telegram value: 0 = Darkness/brightness 1 = Brightness/darkness</p>				
34	Reception	Receives date from bus – Reception	3-byte DPT 11.001	C, W
<p>The group object is enabled if the <i>Date/time by receiver or bus value</i> parameter is set to <i>Bus (external)</i> in the <i>Time standard – Date/Time</i> parameter window.</p> <p>The object is used to send the current date to the device if it does not come from the internal sensor.</p>				
35	Reception	Receives time from bus – Reception	3-byte DPT 10.001	C, W
<p>The group object is enabled if the <i>Date/time by receiver or bus value</i> parameter is set to <i>Bus (external)</i> in the <i>Time standard – Date/Time</i> parameter window.</p> <p>The object is used to send the current time to the device if it does not come from the internal sensor.</p>				
36	Reception	Receives temperature from bus – Reception	1-byte DPT 9.001	C, W
<p>The group object is enabled if the <i>Temperature control depending on internal measurement or external bus value</i> parameter is set to <i>Bus (external)</i> in the <i>Temperature – Temperature control</i> parameter window.</p> <p>The object is used to send the temperature for comparison with the setpoint temperature (temperature control) if it does not come from the internal sensor.</p>				

37	Reception	Receives light value (lux) from bus – Reception	1-byte DPT 9.004	C, W
<p>The group object is enabled if the <i>Light control depending on internal measurement or external bus value</i> parameter is set to <i>Bus (external)</i> in the <i>Light – Light control</i> parameter window.</p> <p>The object is used to send the brightness for light control to the device if it does not come from the internal sensor.</p>				
38	Reception	Receives latitude from bus – Reception	4-byte DPT 14.007	C, W
<p>The group object is enabled if the <i>Coordinates by receiver or bus value</i> parameter is set to <i>Bus (external)</i> in the <i>GPS coordinates and sun data – GPS-coordinates</i> parameter window.</p> <p>The object is used to send the latitude for calculating the sun position to the device if it does not come from the internal sensor.</p>				
39	Reception	Receives longitude from bus – Reception	4-byte DPT 14.007	C, W
<p>The group object is enabled if the <i>Coordinates by receiver or bus value</i> parameter is set to <i>Bus (external)</i> in the <i>GPS coordinates and sun data – GPS-coordinates</i> parameter window.</p> <p>The object is used to send the longitude for calculating the sun position to the device if it does not come from the internal sensor.</p>				
40	Reception	Light control blocking object threshold 1 – Reception	1-bit DPT 1.003	C, W
<p>The group object is enabled if the <i>Activate block object</i> parameter is set to <i>Yes</i> in the <i>Light – Light control: Threshold 1</i> parameter window.</p> <p>The threshold 1 function can be blocked with this object. Triggering of the block depends on the parameter <i>Evaluation of the blocking object</i> and the option <i>Block on 1</i> or <i>Block on 0</i> selected here.</p> <p>Telegram value: 0 = enable/block 1 = block/enable</p>				
41	Reception	Light control blocking object threshold 2 – Reception	1-bit DPT 1.003	C, W
<p>The group object is enabled if the <i>Activate block object</i> parameter is set to <i>Yes</i> in the <i>Light – Light control: Threshold 2</i> parameter window.</p> <p>The threshold 2 function can be blocked with this object. Triggering of the block depends on the parameter <i>Evaluation of the blocking object</i> and the option <i>Block on 1</i> or <i>Block on 0</i> selected here.</p> <p>Telegram value: 0 = enable/block 1 = block/enable</p>				
42	Reception	Temperature control blocking object – Reception	1-bit DPT 1.003	C, W
<p>The group object is enabled if the <i>Activate block object</i> parameter is set to <i>Yes</i> in the <i>Temperature – Temperature control</i> parameter window.</p> <p>The temperature control function can be blocked with this object. Triggering of the block depends on the parameter <i>Evaluation of the blocking object</i> and the option <i>Block on 1</i> or <i>Block on 0</i> selected here.</p> <p>Telegram value: 0 = enable/block 1 = block/enable</p>				

A Appendix

A.1 Scope of delivery

The Time Receiver GPS is supplied together with the following components. Please check your delivery against the list below:

- 1 pc. TR/A 1.1, Time Receiver GPS, SM
- 1 pc. mounting bracket
- 1 pc. sealing ring (rubber)
- 1 set of installation and operating instructions
- 1x bus connection terminal (red/black)

A.2 Code table, 8 bit scene

Bit No.	8-bit value Hexadecimal	7	6	5	4	3	2	1	0		
0	00									1	R
1	01									2	R
2	02									3	R
3	03									4	R
4	04									5	R
5	05									6	R
6	06									7	R
7	07									8	R
8	08									9	R
9	09									10	R
10	0A									11	R
11	0B									12	R
12	0C									13	R
13	0D									14	R
14	0E									15	R
15	0F									16	R
16	10									17	R
17	11									18	R
18	12									19	R
19	13									20	R
20	14									21	R
21	15									22	R
22	16									23	R
23	17									24	R
24	18									25	R
25	19									26	R
26	1A									27	R
27	1B									28	R
28	1C									29	R
29	1D									30	R
30	1E									31	R
31	1F									32	R
32	20									33	R
33	21									34	R
34	22									35	R
35	23									36	R
36	24									37	R
37	25									38	R
38	26									39	R
39	27									40	R
40	28									41	R
41	29									42	R
42	2A									43	R
43	2B									44	R
44	2C									45	R
45	2D									46	R
46	2E									47	R
47	2F									48	R
48	30									49	R
49	31									50	R
50	32									51	R
51	33									52	R
52	34									53	R
53	35									54	R
54	36									55	R
55	37									56	R
56	38									57	R
57	39									58	R
58	3A									59	R
59	3B									60	R
60	3C									61	R
61	3D									62	R
62	3E									63	R
63	3F									64	R

Bit No.	8-bit value Hexadecimal	7	6	5	4	3	2	1	0		
128	80									1	S
129	81									2	S
130	82									3	S
131	83									4	S
132	84									5	S
133	85									6	S
134	86									7	S
135	87									8	S
136	88									9	S
137	89									10	S
138	8A									11	S
139	8B									12	S
140	8C									13	S
141	8D									14	S
142	8E									15	S
143	8F									16	S
144	90									17	S
145	91									18	S
146	92									19	S
147	93									20	S
148	94									21	S
149	95									22	S
150	96									23	S
151	97									24	S
152	98									25	S
153	99									26	S
154	9A									27	S
155	9B									28	S
156	9C									29	S
157	9D									30	S
158	9E									31	S
159	9F									32	S
160	A0									33	S
161	A1									34	S
162	A2									35	S
163	A3									36	S
164	A4									37	S
165	A5									38	S
166	A6									39	S
167	A7									40	S
168	A8									41	S
169	A9									42	S
170	AA									43	S
171	AB									44	S
172	AC									45	S
173	AD									46	S
174	AE									47	S
175	AF									48	S
176	B0									49	S
177	B1									50	S
178	B2									51	S
179	B3									52	S
180	B4									53	S
181	B5									54	S
182	B6									55	S
183	B7									56	S
184	B8									57	S
185	B9									58	S
186	BA									59	S
187	BB									60	S
188	BC									61	S
189	BD									62	S
190	BE									63	S
191	BF									64	S

Empty = Value 0
■ = Value 1, applicable

Note

All combinations not listed or indicated are invalid.

A.3 Ordering details

Short description	Description	Order No.	bbn 40 16779 EAN	Weight 1 pcs. [kg]	Packaging [pcs.]
TR/A 1.1	Time Receiver GPS, SM	2CDG120060R0011	015721	0.09	1

Notes

Notes

ABB i-bus[®] KNX Appendix



ABB STOTZ-KONTAKT GmbH
Eppelheimer Straße 82
69123 Heidelberg, Germany
Telefon: +49 (0)6221 701 607
Telefax: +49 (0)6221 701 724
E-Mail: knx.marketing@de.abb.com

Further Information and Local Contacts:
www.abb.com/knx

© Copyright 2017 ABB. We reserve the right to make technical changes or modify the contents of this document without prior notice. With regard to purchase orders, the agreed particulars shall prevail. ABB AG does not accept any responsibility whatsoever for potential errors or possible lack of information in this document. We reserve all rights in this document and in the subject matter and illustrations contained therein.

Any reproduction, disclosure to third parties or utilization of this contents - in whole or in parts - is forbidden without prior written consent of ABB AG.