

# ASCENDO

ELEVATE YOUR SOUND

## THE **10** **PASSIVE** ON WALL

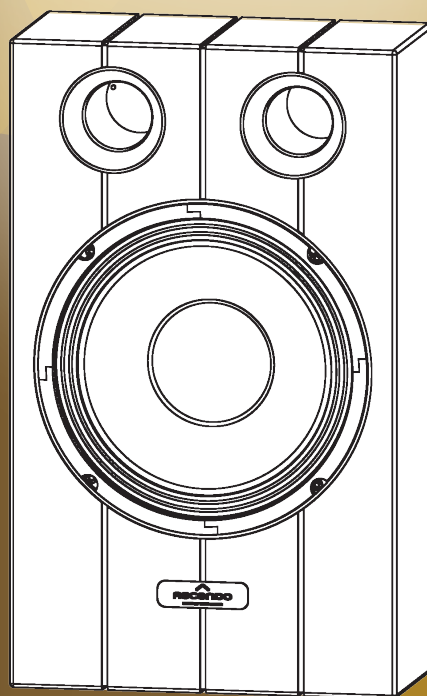

**OPERATION MANUAL**

# THE 10 PASSIVE ON WALL

## Contents

1 IMPORTANT SAFETY INSTRUCTIONS .....	2
2 PACKAGE CONTENTS .....	3
3 SPEAKER PLACEMENT .....	4
4 CONNECTIONS .....	6
5 CARING FOR YOUR PRODUCT .....	7
6 SPECIFICATIONS .....	7
7 DIMENSIONS .....	8
8 DOCUMENTS / RESOURCES .....	8

## IMPORTANT SAFETY INSTRUCTIONS

1. Read these instructions.
2. Keep these instructions.
3. Heed all warnings.
4. Follow all instructions.
5. Clean only with a dry cloth.
6. Install this apparatus in accordance with the manufacturer's instructions.
7. Do not install this apparatus near any heat sources such as radiators, heat registers, stoves or other apparatus.
8. Refer all servicing to qualified service personnel. Servicing is required when the apparatus has been damaged in any way, or the apparatus has been exposed to rain or moisture, does not operate normally or has been dropped.

## DISPOSAL

Correct disposal of this product (Waste Electrical & Electronic Equipment) This symbol means the product must not be discarded as household waste and should be delivered to an appropriate collection facility for recycling. Proper disposal and recycling help protect natural resources, human health, and the environment. For more information on disposal and recycling of this product, contact your local municipality, disposal service, or the shop where you bought this product.

## RoHS

This product is RoHS compliant. This product is in compliance with Directive 2011/65/EU, and its amendments, on the restriction of the use of certain hazardous substances in electrical and electronic equipment.

## REACH

REACH (Regulation No 1907/2006) addresses the production and use of chemical substances and their potential impacts on human health and the environment. Article 33(1) of REACH Regulation requires suppliers to inform the recipients if an article contains more than 0.1 % (per weight per article) of any substance(s) on the Substances of

Very High Concern (SVHC) Candidate List ('REACH candidate list'). At the time of release of this product, no substances of REACH candidate list are contained in a concentration of more than 0.1% per weight in this product.

## THANK YOU FOR CHOOSING ASCENDO IMMERSIVE AUDIO.

For more than 24 Years, ASCENDO has been involved in music reproduction. We are confident that the AIA product you have chosen will provide every note of enjoyment that you expect.

Please take a moment to register your product on our website at [www.aia-cinema.com](http://www.aia-cinema.com). This enables us to keep you posted on our latest advancements and helps us to better understand our customers and build products that meet their needs and expectations. All features and specifications are subject to change without notice.

## PACKAGE CONTENTS

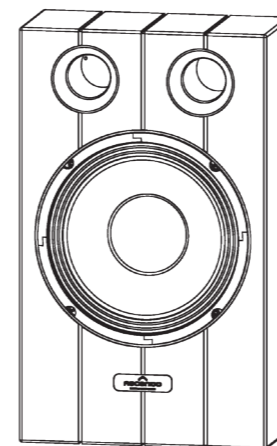

1 x The10  
PASSIVE  
ON WALL

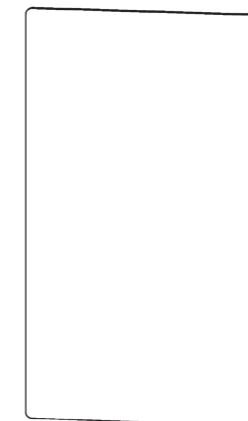

1 x Grille



1 x Quick Start Guide

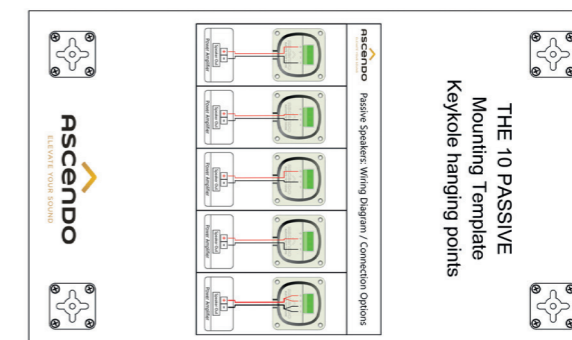

1xDrillingTemplate

## SPEAKER PLACEMENT

Positioning your loudspeakers properly is critical to achieve the sonic performance of a home theater. Please read the following section for guidance in correct and optimal placement.

### LEFT, RIGHT and CENTER speakers

The THE10 PASSIVE ON WALL is a perfect choice to serve as powerful front left right and center main speakers in a multi-channel system. Since they have been designed for uniform coverage and maximum dispersion of sound, they should be placed with the center of the speaker driver at about the same height on screen as the actors to aid in the illusion that the actors' voices are coming directly from their on-screen images. Ideally, the speakers will be placed about 60 degrees apart from each other viewed from the listening position, so that the distance between the speakers is the same as each speaker's distance.

The recommended mounting of the THE10 PASSIVE ON WALL is horizontal or vertical because the speakers possess an axi-periodic dispersion pattern.

If a non-perforated projection screen, LCD/plasma/OLED display is being used in the installation, the THE10 PASSIVE ON WALL may be used in horizontal orientation mounted directly below or above and as close as possible to the video display.

NOTE: In such an installation scenario it is extremely important to place the center, left and right speakers as close as possible to the same height. The center of the speaker driver in the center channel speaker should be no more than 2 feet (61cm) higher or lower than those in the left and right speakers. This preserves the localization integrity of "sound pans" in which the sound appears to move from left to center to right. If the program material also appears to travel up and down, it can destroy the illusion of lifelike panning effects. To mitigate the height difference between the center speaker the Left and Right channel speakers should be lowered or elevated slightly depending on if the center is installed below or above the screen.

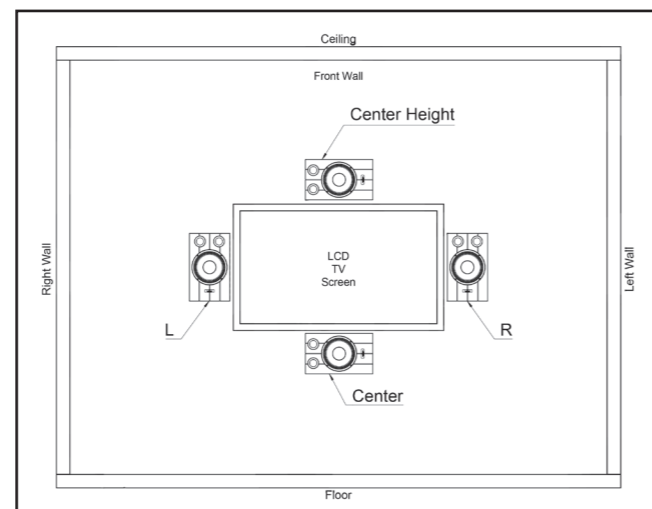
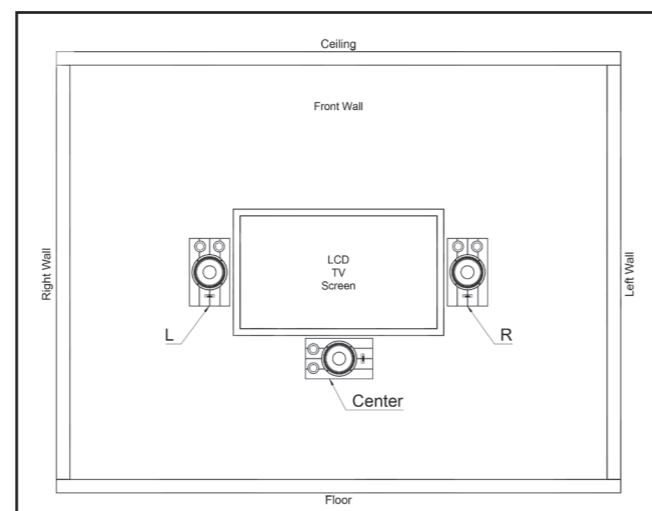
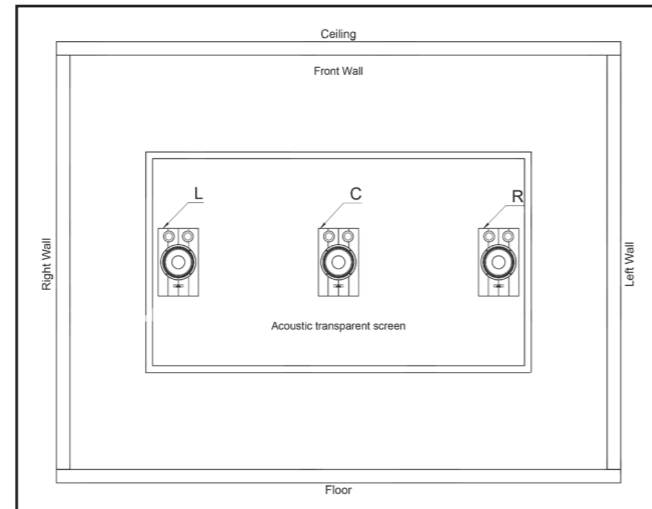

### Using the speakers as surround speakers

Surround speakers should be placed on or in the side walls no closer to the screen than the first row of viewing chairs. If there are two rows of chairs, these speakers should be placed between the two rows. Surround speakers should be placed higher than the seating area. Rule of thumb is that the center of the speaker cone should have direct access to each ear with all seats occupied, so that no occlusion of direct line of sight happens between the tweeter and each ear.

### Using the speakers as rear surround speakers.

Rear Surround speakers should be placed on or in the rear walls. Rear Surround speakers should be placed higher than the seating area. Rule of thumb is that the center of the speaker cone should have direct access to each ear with all seats occupied. This is especially challenging with seats possessing really high back supports. Ideally no occlusion of direct line of sight happens between the tweeter and each ear.

### Listening distance and volume variation.

Ideally the minimum listening distance is 2 meters or 12 feet to a surround speaker. The minimum and the maximum listening distance variation should be as low as possible, i.e. minimum 2 meters, maximum 4 meters, which reduces the listening volume difference to 6dB at worst case.

## Possible speaker positions

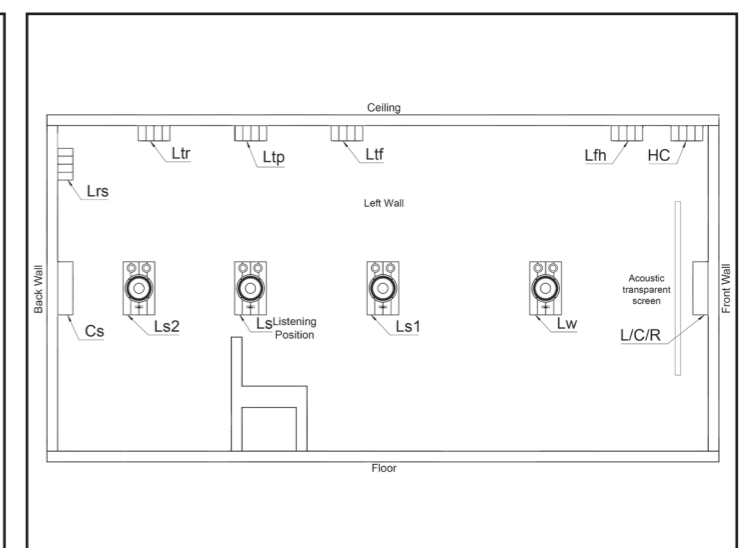
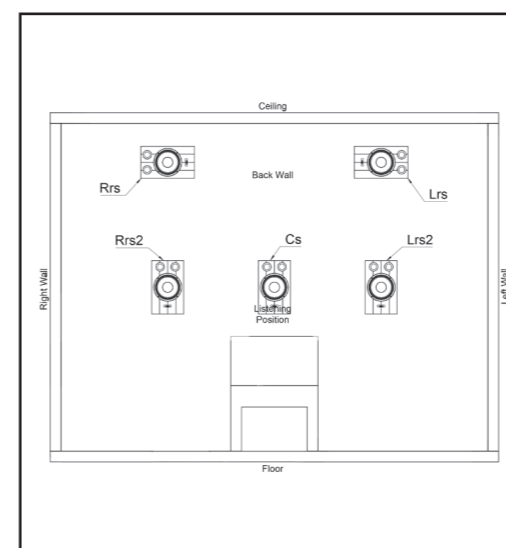
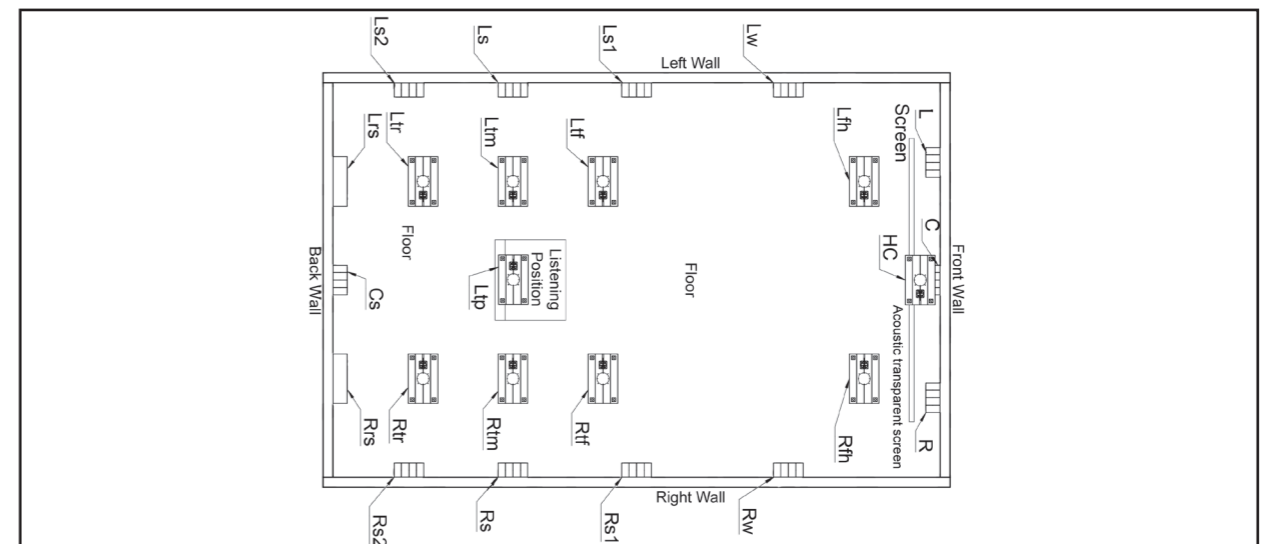
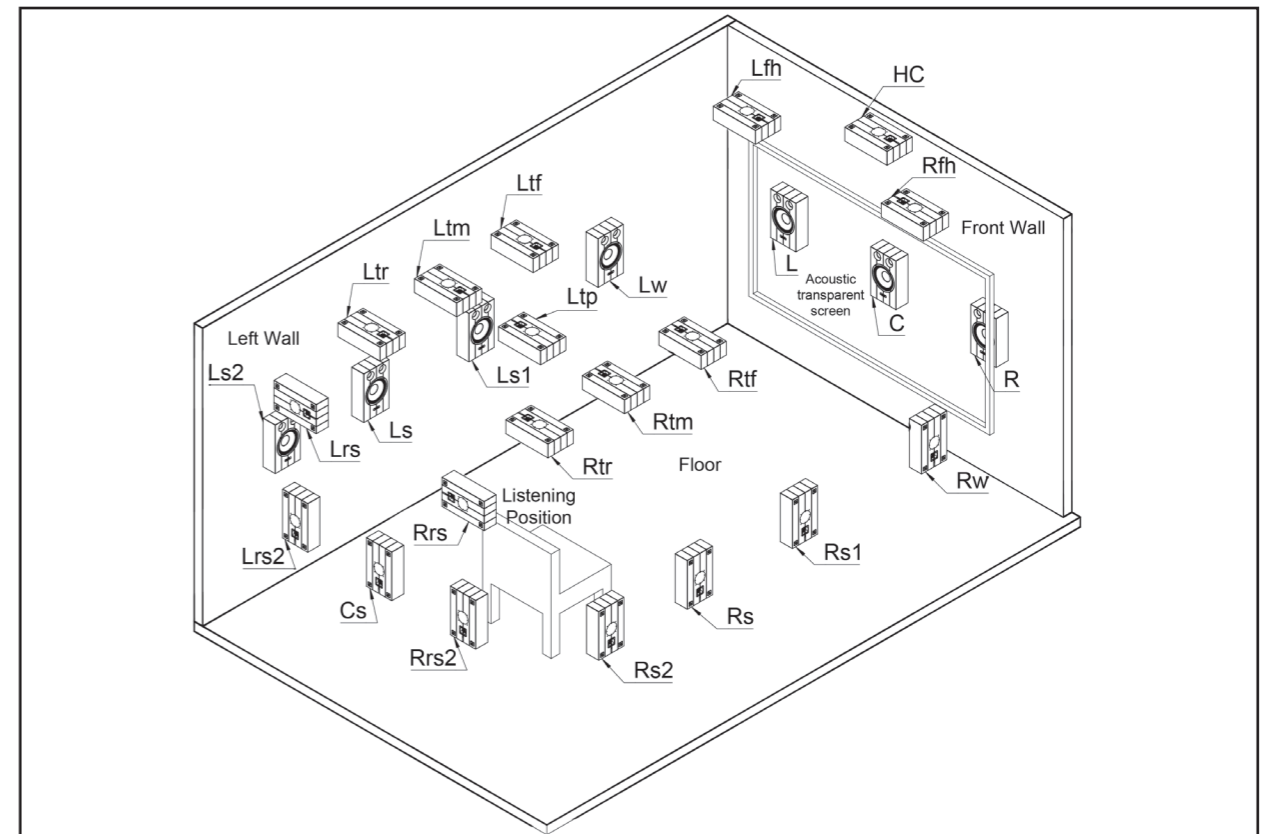

## CONNECTIONS

Speakers and electronics have corresponding (+) and (-) terminals. Most manufacturers of speakers and electronics, use red to denote the (+) terminal and black for the (-) terminal. It is important to connect both terminals identically: (+) on the speaker to (+) on the amplifier, and (-) on the speaker to (-) on the amplifier.

This connection ensures, that all speakers work in unison and make a forward movement if a positive signal is applied and move backward when a negative signal is applied.

It is important to connect all speakers identically: (+) on the speaker to (+) on the amplifier and (-) on the speaker to (-) on the amplifier. Wiring any one speaker "out of phase" (+ to - and - to +) to other speakers in the system results in thin sound, weak bass and poor imaging. With the advent of multichannel surround sound systems, connecting all the speakers in your system with the correct polarity remains equally important to preserve the proper ambience and directionality of the program material.

THE10 PASSIVE ON WALL uses both (+) (+) and (-) (-) for its connection, please see image for possible connecting options. Both (+) (+) and (-) (-) are internally connected.

The (+) terminal of the dedicated amplifier channel must be connected to the (+) terminal(s) of the speaker as the (-) terminals of the amp need to be connected to the (-) terminal(s) of the speaker.

In this wiring configuration, the amplifier will be presented with a nominal 8 Ohms speaker load.

THE10 PASSIVE ON WALL is specifically designed for use in conjunction with low noise amplifiers where the residual noise floor of the amplifier should be below 40µV.

Connect your main receiver or processor's output to the line-level input on your amplifier.

### CONNECTING THE SPEAKERS TO AMPLIFICATION

To connect THE10 PASSIVE ON WALL subwoofer to power amplifier(s) or receiver, use two-conductor insulated speaker wire. Wire length Recommended Size.

Up to 40 ft. (12m) 14-gauge

Up to 60 ft. (20m) 12-gauge

THE10 PASSIVE ON WALL push on phoenix connectors can accommodate up to #12 AWG stranded wire.

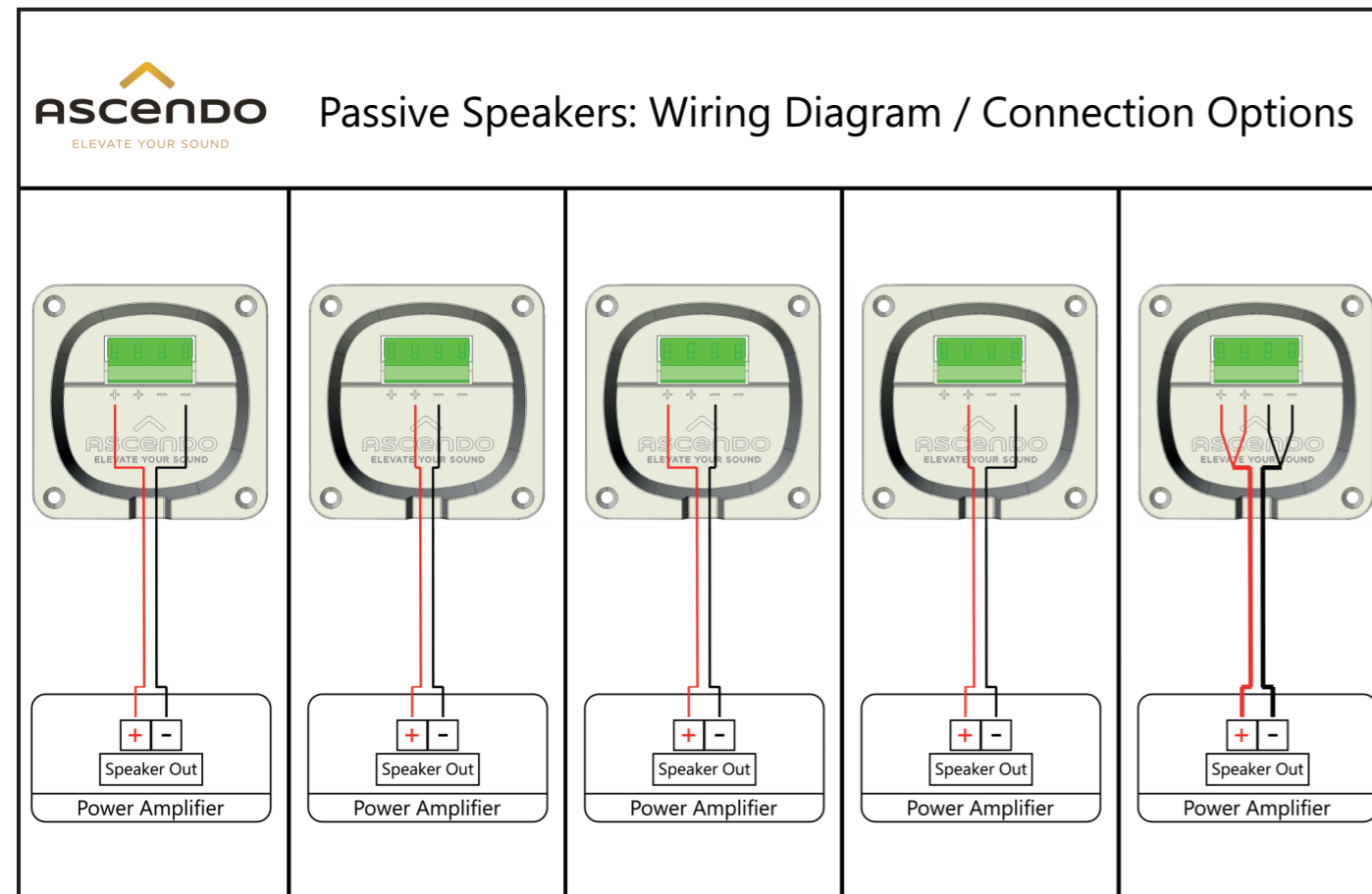

## CARING FOR YOUR PRODUCT

Wipe the cabinet with a clean, dry cloth to remove dust. A damp cloth may dull the cabinet's finish. Do not use volatile liquids such as benzene, paint thinner or alcohol on the cabinet.

Do not spray insecticide near the cabinet.

To remove dust from the grille fabric, use a vacuum cleaner, soft brush and set to low suction.

Do not wash the grille in water, as water may fade the grille's color or make it uneven.

If the surface of the woofer cone becomes dusty you can carefully sweep it clean with a soft, dry calligraphy brush or paint brush or low air pressure. Do not use a damp cloth.

## SPECIFICATIONS

Modell	THE10 PASSIVE ON WALL
Speaker Type	10" Time coherent point-source coaxial
Passive   Active	Passive
Principle	Vented
SPL	Measured data 120 dB cont. / 130 dB peak
Frequency Range	Measured data 100 Hz – 20 kHz / -3dB
Efficiency	97 dB / 1W/m
Power handling	500 W
Impedance	8 Ω
Woofer	10" woofer
Tweeter	1.44" Compression driver
Directivity horizontal x vertical in Deg°	85° x 85°
Input Terminal	One 4-conductor Phoenix 12 AWG (3,3 mm <sup>2</sup> ) push on binding post
Enclousure	MDF
Dimensions (W/H/D) mm	300 / 500 / 145 (154 with grille)
Dimensions (W/H/D) inch	11,81 / 19,69 / 5,70 (6,06 with grille)
Packing dimensions (W/H/D) mm	440 / 640 / 280
Packing dimensions (W/H/D) inch	17,32 / 25,20 / 11,02
Weight	12 kg   30,86 lbs
Gross Weight	14 kg   30,86 lbs
Finish	Matte black
Mounting	4 x wall brackets for horizontal and vertical installation + VESA 100 x 100 mounting points

Technical modifications subject to change without further notice

## DIMENSIONS

THE10 PASSIVE ON WALL

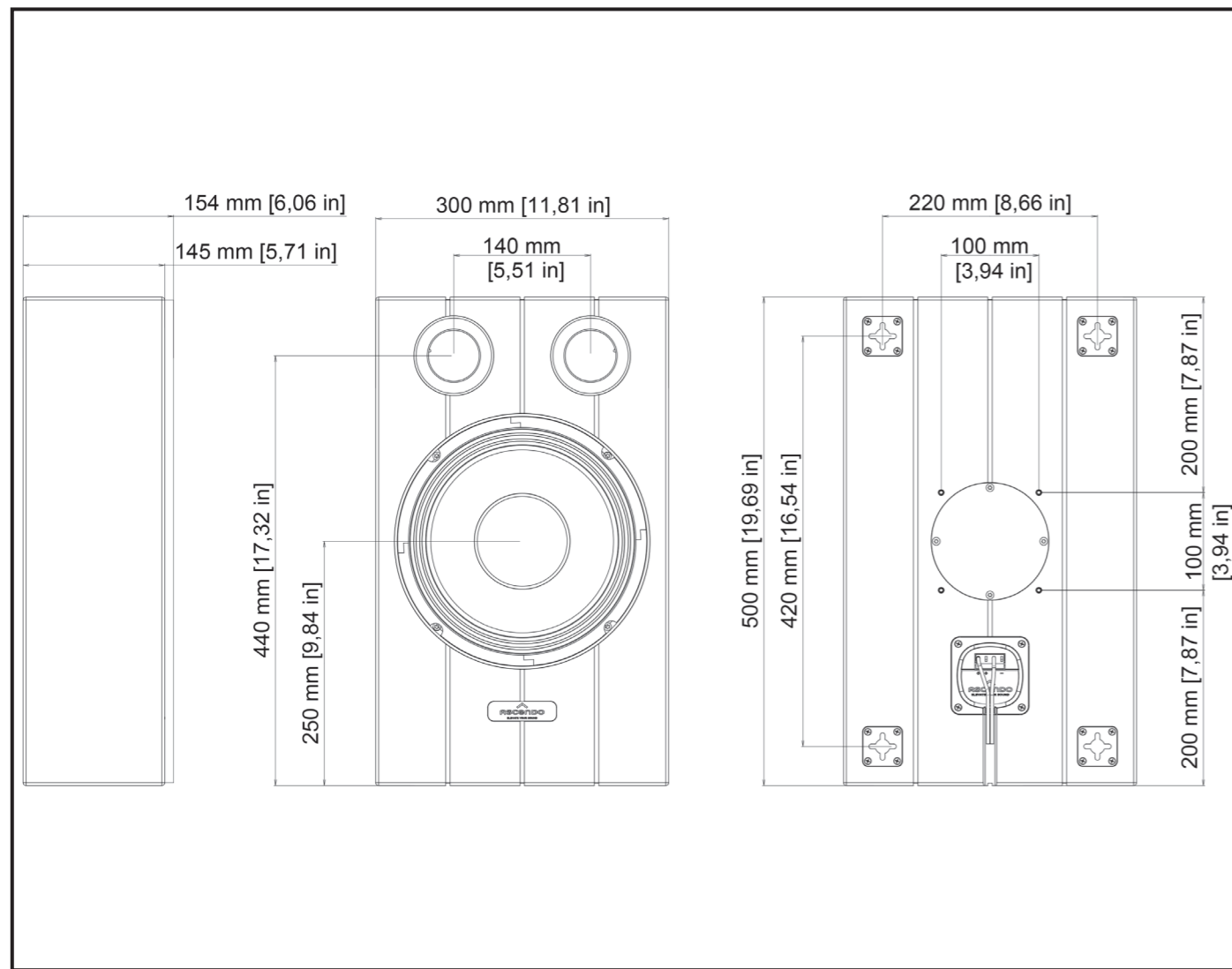

## DOCUMENTS RESOURCES



ASCENDO\_THE10 PASSIVE ON WALL (pdf)

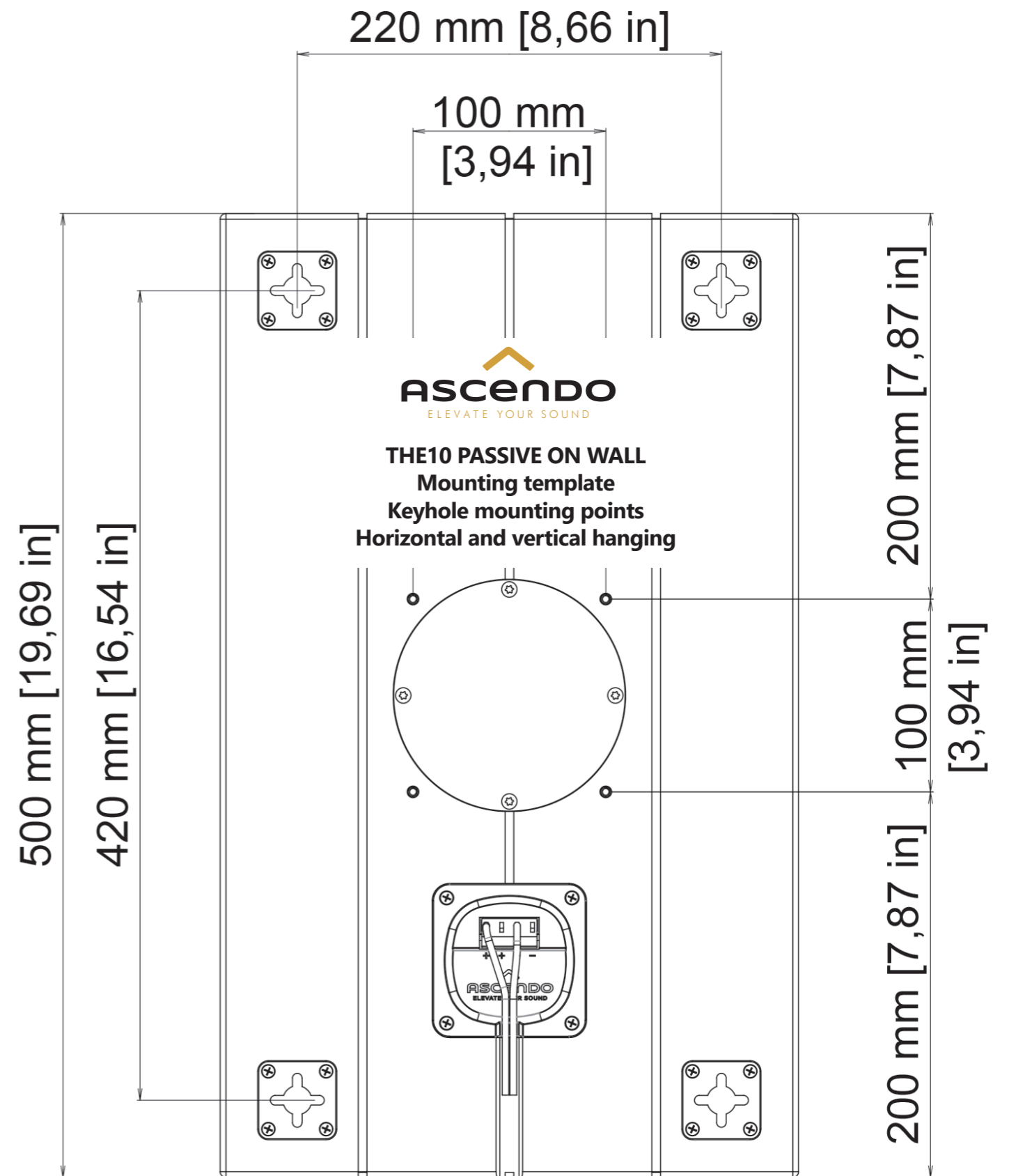

  
**ASCENDO**  
ELEVATE YOUR SOUND



CE

**ASCENDO Immersive Audio GmbH**

Adlerstrasse 2, Gebäude C, EG

D-91560 Heilsbronn · Germany

Tel.: +49 9872 9 537 157 · [www.aia-cinema.com](http://www.aia-cinema.com)

