



Square Wireless Configurable Keypad Installation Guide



Introduction

The Control4® Square Wireless Configurable Keypad is intended for use in a Control4 system. It installs in a standard square (UK/China-style) or round (EU-style) wall box using typical wiring standards and communicates to the Control4 system using a wireless connection.

Box contents









- Square Wireless Configurable Keypad
- *Square Wireless Configurable Keypad Installation Guide* (this document)
- M3.5 machine screws (2) 
- M4.0 machine screws (2) 
- M3.0 thread-cutting screws (2) 

Specifications

The specifications are described below.

Model number	C4-SKC
Power requirements	120VAC-277VAC +/-10% 50/60 Hz 36-48VDC This device requires a neutral AC connection except when used in combination with a Control4 Dimmer in a multi-location scenario.
Power consumption	120V: 350mW 240V: 480mW 277V: 540mW 36VDC: 430mW
Environmental	
Operational temperature	0°C - 40°C (32°F - 104°F)
Humidity	5% to 95% non-condensing
Storage	-20°C - 70°C (-4°F - 158°F)
Miscellaneous	
Control communications	ZigBee, IEEE 802.15.4, 2.4 GHz, 15-channel spread spectrum radio
Wires per connector	One 0.5 mm ² - 2.5 mm ² (20AWG - 10AWG) OR Two 0.5 mm ² - 1.5 mm ² (20AWG - 16AWG)
Dimensions	83 × 71 × 17 mm (3.3 × 2.8 × 0.7 in)
Weight	0.05 kg (0.12 lb)
Shipping weight	0.08 kg (0.18 lb)

Warnings and considerations

-  **Warning!** Turn OFF electrical power before installing or servicing this product. Improper use or installation can cause SERIOUS INJURY, DEATH or LOSS/DAMAGE OF PROPERTY.
- Attention !** Coupez l'alimentation électrique avant d'installer ou de réparer ce produit. Une mauvaise installation ou utilisation peut entraîner des blessures graves, décès ou perte / dommages à la propriété.
-  **Warning!** This device must be protected by a circuit breaker (20A max).
- Attention !** Cet appareil doit être protégé par un disjoncteur (20A max).
-  **Important:** When installing the keypad in a round wall box, a Trim Ring (sold separately) must be installed between the keypad and the wall box. Trim Rings are available in both single-gang and dual-gang versions.
-  **Important:** This device must be installed by a licensed electrician in accordance with all national and local electrical codes.
-  **Important:** Use this device only with copper or copper-clad wire. Do not use aluminum wiring. This product has not been approved for use with aluminum wiring.
-  **Important:** Using this product in a manner other than outlined in this document voids your warranty. Further, Control4 is NOT liable for any damage incurred with the misuse of this product. See "Troubleshooting."
-  **Important:** Do NOT use a power screwdriver to install this device. If you do, you may overtighten the screws and strip them. Also, overtightening the screws may interfere with proper button operation.
-  **Important:** This is an electronic device with intricate components. Handle and install with care!

Installation instructions

- Ensure that the location and intended use meet the following criteria:
 - When replacing a traditional multi-way (cross) switch, refer to the "Two-Location" sample wiring configurations provided in the appropriate load control device installation guide.
 - Install in accordance with all national and local electrical codes.
 - The range and performance of the wireless control system is highly dependent on the following: (1) distance between devices; (2) layout of the home; (3) walls separating devices; and (4) electrical equipment located near devices.
- Turn off the mains electrical power at the consumer unit. To ensure the wires do *not* have power running to them, use an inductive voltage detector.
- Determine whether the keypad will be installed in a square or round wall box. If the keypad is to be installed in a round wall box, ensure that the appropriate trim ring (sold separately) is available before proceeding.
- Prepare each wire. Wire insulation should be stripped back 7mm from the wire end.
- If installing in a round wallbox, pull the wires through the center hole in the trim ring. The arrows on the trim ring should face forward and up.
- Connect the keypad to the wall box wires as shown in Figure 1 below. (Refer to the *C4-SAPD240 Dimmer Installation Guide* or the *C4-SSW240 Switch Installation Guide* for multi-location wiring details.)

Figure 1: Keypad wiring

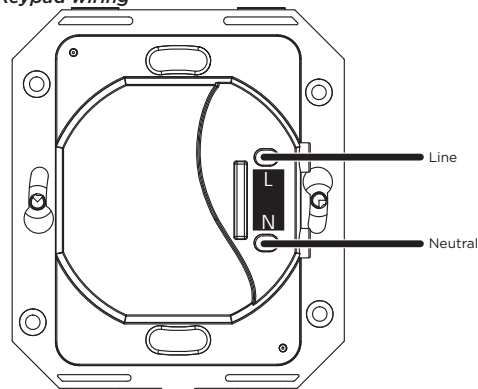

- Fit the wires back into the wall box.

8 Follow the appropriate instructions for attaching the keypad:

To install in a square (UK/China-style) wall box:

- a Align the keypad to the wall box as shown in Figure 1 (note the **UP** orientation arrow on the keypad), then fasten the keypad to the wall box using the included M3.5 machine screws (UK-style wall box) or M4.0 machine screws (China-style wall box).

Figure 2: Square wall box installation



To install in an EU-style round wall box with mounting screws on the left and right:

- a Align the keypad and the trim ring to the wall box as shown in Figure 2 (note the **UP** orientation arrow on the trim ring and dimmer).
- b Fasten the keypad and trim ring to the wall box using either the included M3.0 thread cutting screws or the screws that came pre-installed in the wall box. Note that some pre-installed screws may not have large enough screw heads to securely hold the keypad.

Figure 3: Round wall box installation—horizontal screw holes

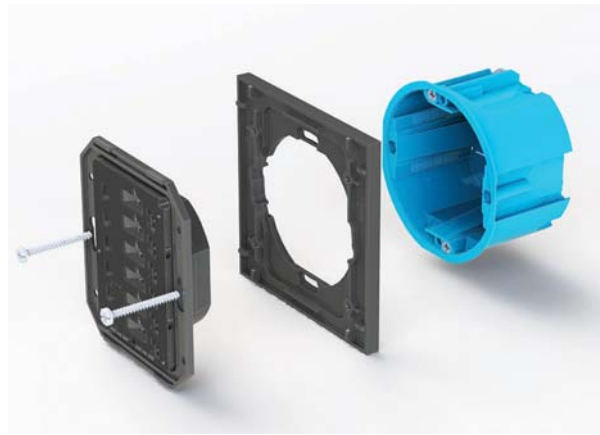

To install in an EU-style round wall box with mounting screws on the top and bottom:

- a Align the trim ring to the wall box as shown in Figure 3 (observe the **UP** orientation arrow on the trim ring).
- b Fasten the trim ring to the wall box using either the included M3.0 thread cutting screws or the screws that came pre-installed in the wall box. Note that some pre-installed screws may not have large enough screw heads to securely hold the trim ring.
- c Attach the keypad to the trim ring with four M2.2 x 6 mm thread-forming screws included with the trim ring as shown in Figure 3.

Figure 4: Round wall box installation—vertical screw holes



Note: For instructions on installing in a dual EU-style wall box with a dual trim ring, refer to the *Dual Trim Ring Installation Guide*.



IMPORTANT! Tighten the screws until the device or trim ring is flush with the wall surface, but no further. Overtightening can warp the keypad and cause it to malfunction.

- 9 Attach the buttons (sold separately) as described in the *Keypad Button Installation Guide*.
- 10 Install the Control4 faceplate (sold separately) by placing the top of the faceplate (observe the up arrow on inside of faceplate) on the device and firmly pressing the bottom until the faceplate snaps into place against the wall.



Note: To remove the faceplate, use a flathead screwdriver. Insert the screwdriver into the small gap on the bottom between the faceplate and the device. Twist the screwdriver blade to pop the faceplate off.

- 11 Turn ON mains electrical power at the consumer unit.

Operation and configuration

On initial power up, all status LEDs on the keypad will illuminate green indicating that the device has power. Until the keypad has been configured into a Control4 system, it will not control any loads. To set up this keypad for use with a Control4 system, refer to the *Composer Pro User Guide* (ctrl4.co/cpro-ug).

Button tap sequences

The button tap sequences are defined in the table below. Button tap sequences that require a single button should use the top-most button installed on the keypad. Button tap sequences requiring two buttons should use the top-most and bottom-most buttons installed on the keypad.

Function	Button sequence
Identify	4
ZigBee channel	7
Reboot	15
Factory reset	9-4-9
Leave mesh and reset	13-4-13

Troubleshooting

If the LEDs do not light up indicating that the keypad is receiving power:

- Ensure circuit breaker is not turned OFF or tripped.
- Perform a factory reset tap sequence (9-4-9).
- Check for proper wiring (see “Installation Instructions” above).
- For help on the installation or operation of this product, email or call the Control4 Technical Support Center. Please provide your exact model number. Contact support@control4.com or see the web site www.control4.com.

Care and cleaning

- Clean surface of the keypad with a soft damp cloth as needed.
- Do NOT paint the keypad or its wall plate.
- Do NOT use any chemical cleaners to clean the keypad.

Additional resources

The following resources are available for additional support:

- Control4 Knowledgebase and forums
- Control4 Technical Support
- Control4 website: www.control4.com
- Composer documentation available at ctrl4.co/docs.

For the latest version of this document, open this URL or scan the QR code on a device that can view PDFs.



Regulatory and safety information

To review regulatory information for your particular Control4 products, see the information located on the Control4 website at ctrl4.co/reg.

Patent information

Applicable patents are available at ctrl4.co/patents.

Warranty

Visit ctrl4.co/warranty for details.



Control4®

control4.com | 888.400.4070

Copyright ©2016, Control4 Corporation. All rights reserved. Control4, the Control4 logo, the 4-ball logo, 4Store, 4Sight, Control4 My Home, and Everyday Easy are registered trademarks or trademarks of Control4 Corporation in the United States and/or other countries. All other names and brands may be claimed as the property of their respective owners. All specifications subject to change without notice.

E
200-00419-E
2016-02-04 MS