



## INSTALLATION MANUAL

### Mini-5.1 AVR



REAL. LIFE. SOUND.



## REGULATORY COMPLIANCE AND SAFETY INFORMATION

### Electrical Safety Advisory Sécurité électrique consultatif

#### Important Safety Instructions Consignes de sécurité importantes

Read the safety instructions before using this product.  
Lisez les consignes de sécurité avant d'utiliser ce produit.

1. Read these instructions.  
Lisez ces instructions.
2. Keep these instructions.  
Conservez ces instructions.
3. Heed all warnings.  
Respectez tous les avertissements.
4. Follow all instructions.  
Suivez toutes les instructions.
5. Do not use this apparatus near water.  
Ne pas utiliser cet appareil près de l'eau.
6. Clean only with dry cloth.  
Nettoyez-le uniquement avec un chiffon sec.
7. Do not block any ventilation openings. Install in accordance with the manufacturer's instructions.  
Ne pas bloquer les ouvertures de ventilation. Installer conformément aux instructions du fabricant.
8. Do not install near any heat sources such as radiators, heat registers, stoves, or other apparatus (including amplifiers) that produce heat.

Ne pas installer près de sources de chaleur telles que des radiateurs, registres de chaleur, poêles, ou autres appareils (incluant les amplificateurs) qui produisent de la chaleur.

9. Do not defeat the safety purpose of the polarized or grounding-type plug. A polarized plug has two blades with one wider than the other. A grounding type plug has two blades and a third grounding prong. The wide blade or the third prong is provided for your safety. If the provided plug does not fit into your outlet, consult an electrician for replacement of the obsolete outlet.

Ne pas contourner le dispositif de sécurité de la fiche polarisée ou de mise à la terre. Une fiche polarisée possède deux lames dont une plus large que l'autre. Une fiche de terre a deux lames et un troisième broche de terre. La lame large ou le troisième broche est fournie pour votre sécurité. Si la fiche fournie ne s'adapte pas à votre prise, consultez un électricien pour le remplacement de la prise obsolète.



10. Protect the power cord from being walked on or pinched particularly at plugs, convenience receptacles, and the point where they exit from the apparatus.

Protégez le cordon d'alimentation ne soit piétiné ou pincé, en particulier au niveau des fiches, des prises et au point où il sort de l'appareil.

11. Only use attachments/accessories specified by the manufacturer. Utilisez uniquement des fixations/ accessoires spécifiés par le fabricant.
12. Use only with the cart, stand, tripod, bracket, or table specified by the manufacturer, or sold with the apparatus. When a cart is used, use caution when moving the cart/apparatus combination to avoid injury from tip-over.

Utilisez uniquement avec le chariot, le socle, le trépied, le support ou la table spécifiés par le fabricant ou vendu avec l'appareil. Lorsque vous utilisez un chariot, soyez prudent lorsque vous déplacez l'ensemble chariot/ appareil pour éviter des blessures dues au renversement.



13. Unplug this apparatus during lightning storms or when unused for long periods of time.

Débranchez cet appareil pendant les orages ou lorsqu'il n'est pas utilisé pendant de longues périodes de temps.

14. Refer all servicing to qualified service personnel. Servicing is required when the apparatus has been damaged in any way, such as power-supply cord or plug is damaged, liquid has been spilled or objects have fallen into the apparatus, the apparatus has been exposed to rain or moisture, does not operate normally, or has been dropped.

Confiez toutes les réparations à un personnel qualifié. Une réparation est nécessaire lorsque l'appareil a été endommagé de quelque façon que ce soit le cordon d'alimentation ou la fiche est endommagé, du liquide a été renversé ou si des objets sont tombés dans l'appareil, l'appareil a été exposé à la pluie ou à l'humidité, ne fonctionne pas normalement, ou s'il est tombé.



15. This equipment uses AC power which can be subjected to electrical surges, typically lightning transients which are very destructive to customer terminal equipment connected to AC power sources. The warranty for this equipment does not cover damage caused by electrical surge or lightning transients. To reduce the risk of this equipment becoming damaged it is suggested that the customer consider installing a surge arrester.

Cet équipement utilise la puissance AC qui peuvent être soumis à des surtensions électriques, la foudre généralement transitoires qui sont très destructives envers les équipements terminaux connectés à des sources d'alimentation CA. La garantie de cet appareil ne couvre pas les dommages causés par les surtensions électriques ou transitoires de foudre. Pour réduire le risque de cet équipement devient endommagé, il est suggéré que le client envisage l'installation d'un limiteur de surtension.

16. To completely disconnect unit power from the AC mains, remove the power cord from the appliance coupler and/or turn off the circuit breaker. To reconnect power, turn on the circuit breaker following all safety instructions and guidelines. The circuit breaker shall remain readily accessible.

Pour débrancher complètement l'alimentation secteur du réseau secteur, retirez le cordon d'alimentation du coupleur de l'appareil et / ou éteignez le disjoncteur. Pour reconnecter l'alimentation, allumez le disjoncteur en suivant toutes les consignes et consignes de sécurité. Le disjoncteur doit être facilement accessible.

17. This product relies on the buildings installation for short-circuit (overcurrent) protection. Ensure that the protective device is rated not greater than: 20A.

Ce produit repose sur l'installation des bâtiments pour les courts-circuits (surintensité) de protection. Assurez-vous que le dispositif de protection est assignée ne dépassant pas: 20A.

18. Never push objects of any kind into this product through cabinet slots as they may touch dangerous voltage points or short out parts that could result in fire or electric shock.

N'introduisez jamais d'objets d'aucune sorte dans ce produit à travers les fentes du boîtier car ils pourraient toucher des points de tension dangereux ou court-circuiter des pièces qui pourraient entraîner un incendie ou un choc électrique.

19. This product can interfere with electrical equipment such as tape recorders, TV sets, radios, computers and microwave ovens if placed in close proximity.

Ce produit peut interférer avec des appareils électriques tels que les magnétophones, téléviseurs, radios, ordinateurs et fours à micro-ondes placés à proximité.



The lightning flash and arrow head within the triangle is a warning sign alerting you of dangerous voltage inside the product

L'éclair et la flèche dans le triangle est un signe d'alerte pour vous avertir d'une tension dangereuse à l'intérieur du produit

Caution: To reduce the risk of electric shock, do not remove cover (or back). No user serviceable parts inside. Refer servicing to qualified service personnel.



Attention: Pour réduire le risque de choc électrique, ne pas retirer le couvercle (ou l'arrière). Aucune pièce réparable par l'utilisateur. Confiez l'entretien à un personnel qualifié.

The exclamation point within the triangle is a warning sign alerting you of important instructions accompanying the product.



Le point d'exclamation dans un triangle est un signe d'avertissement qui signale des instructions importantes accompagnant le produit.



AC voltage: This symbol indicates that the rated voltage marked with the symbol is AC voltage.

**CAUTION:** FOR CONTINUED PROTECTION AGAINST THE RISK OF FIRE REPLACE ONLY WITH SAME TYPE OF FUSE.

Save these instructions  
Conservez ces instructions



**Intertek**

Compliance of this equipment is confirmed by the following label that is placed on the equipment:

Conformité de cet appareil est confirmée par le symbole suivant qui est placé sur l'équipement:



## USA Compliance

### FCC Part 15, Subpart B & IC Unintentional Emissions Interference Statement

This equipment has been tested and found to comply with the limits for a Class B digital device, pursuant to Part 15 of the FCC rules. These limits are designed to provide reasonable protection against harmful interference when the equipment is operated in a residential installation. This equipment generates uses and can radiate radio frequency energy and, if not installed and used in accordance with the instructions, may cause harmful interference to radio communications. However, there is no guarantee that interference will not occur in a particular installation. If this equipment does cause harmful interference to radio or television reception, which can be determined by turning the equipment off and on, the user is encouraged to try to correct the interference by one or more of the following measures:

- Reorient or relocate the receiving antenna.
- Increase the separation between the equipment and receiver.
- Connect the equipment into an outlet on a circuit different from that to which the receiver is connected.
- Consult the dealer or an experienced radio/TV technician for help.

This device complies with part 15 of the FCC rules. Operation is subject to the following two conditions: (1) This device may not cause harmful interference, and (2) this device must accept any interference received, including interference that may cause undesired operation.

Cet appareil est conforme à la section 15 des règles. Son utilisation est soumise aux deux conditions suivantes: (1) Cet appareil ne doit pas causer d'interférences nuisibles et (2) cet appareil doit accepter toutes les interférences reçues, y compris celles pouvant entraîner un fonctionnement non souhaité.

**IMPORTANT!** Any changes or modifications not expressly approved by the party responsible for compliance could void the user's authority to operate this equipment.

**IMPORTANT!** Tous les changements ou modifications pas expressément approuvés par la partie responsable de la conformité ont pu vider l'autorité de l'utilisateur pour actionner cet équipement.

## Canada Warning Statement

CAN ICES-3 (B)/NMB-3(B)

- This product meets the applicable Innovation, Science and Economic Development Canada technical specifications.
- Ce produit répond aux spécifications techniques applicables à l'innovation, Science et Développement économique Canada.



## Europe Compliance

Compliance of this equipment is confirmed by the following logo that is placed on the product ID label that is placed on the bottom of the equipment. The full text of the EU Declaration of Conformity (DoC) is available on the regulatory webpage:



## Australia & New Zealand Compliance

Compliance of this equipment is confirmed by the following logo that is placed on the product ID label that is placed on the bottom of the equipment.



## Recycling

Wirepath Home Systems, LLC understands that a commitment to the environment is essential for a health life and sustainable growth for future generations. We are committed to supporting the environmental standards, laws, and directives that have been put in place by various communities and countries that deal with concerns for the environment. This commitment is represented by combining technological innovation with sound environmental business decisions.

## WEEE Compliance

Wirepath Home Systems, LLC is committed to meeting all requirements of the Waste Electrical and Electronic Equipment (WEEE) directive (2012/19/EC). The WEEE directive requires the manufacturers of electrical and electronic equipment who sell in EU countries: (1) label their equipment to notify customers that it needs to be recycled, and (2) provide a way for their products to be appropriately disposed of or recycled at the end of their product lifespan. For collection or recycling of Wirepath Home Systems, LLC products, please contact your local Wirepath Home Systems, LLC representative or dealer.



## FRONT AND REAR PANEL DESCRIPTIONS

### Front panel

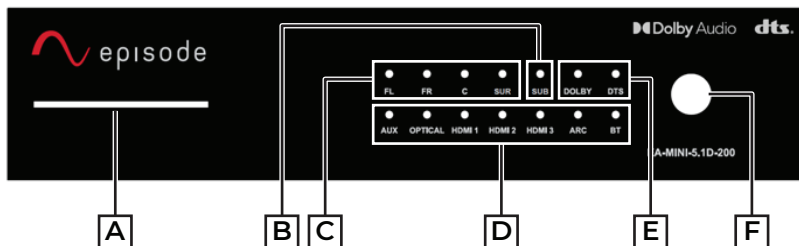

- A.** Power LED light bar: Blue is at its highest intensity on the left side of the light bar.
  - Blue LED on = Amplifier is active or in standby mode.
  - Blue LED off = Amplifier power is off.
- B.** SUB (LFE) channel LED: Displays the status for sub out.
  - Blue LED: LFE signal has been decoded (is present), and audio is being sent to the subwoofer line out.
  - LED off: LFE signal is not present.
- C.** Speaker channel LEDs: Indicate the amplifier's operating state. Each channel has one bi-color LED.
  - Blue LED: Amplifier is on and functioning properly.
  - Red LED: Amplifier is on and is *not* functioning properly. Check for possible short at speaker output.
  - LED off (when power LED is blue): Amplifier channel is off.
- D.** Input LED: Blue LED displays the active input source.
  - Blue LED: The input source is active.
  - LED off: The input source is inactive.
- E.** Decoding LED: Displays the status for Dolby/DTS decoding.
  - Blue LED: Dolby/DTS input signal is decoding.
  - LED off: No Dolby/DTS signal is being received via input.
- F.** Power button:
  - Press and release (momentary) to turn on or put it into Standby mode.
  - Press and hold for 10 seconds to put it into deep Standby mode (<0.5W).





## Back panel

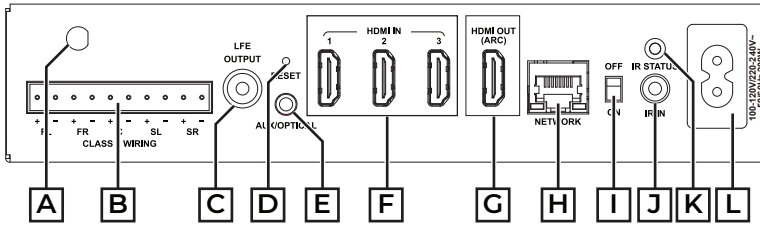

- A.** Bluetooth Antenna
- B.** Speaker outputs: 10-position Phoenix-style connectors for 5-channel speaker wiring.
- C.** LFE OUTPUT (subwoofer output): Unbalanced port to connect an external subwoofer.
- D.** RESET: A pinhole button for resetting the amplifier.
  - Quick momentary press = Reboot.
  - Press and hold for 5 seconds = Returns network to DHCP defaults.
  - Press and hold for 10+ seconds = Returns device to its factory default configuration.
- E.** AUX/OPTICAL input: 3.5 mm combo jack.
  - 3.5 mm stereo port for connection to the analog line output of your audio/video source.
  - 3.5 mm optical adapter for connecting to the optical audio output of your TV or other audio/video source.
- F.** HDMI IN ports (3): HDMI type A connector for connecting to the HDMI output of your audio/video source.
- G.** HDMI OUT (ARC) [audio return channel]: HDMI type A connector (1).
  - For connection to the HDMI(ARC) input on your TV
- H.** Network: Standard RJ45 connector with LED indicator. 10/100 Ethernet. Port remains active when amp is in Standby mode.
- I.** IR power ON/OFF: If on, +12V DC is applied to the IR IN jack, providing power for an external IR receiver.
  - Note: Do not turn on IR power if a direct connection to a control system is used.
- J.** IR Status: LED illuminates when the IR signal is received
- K.** IR IN: 3.5 mm stereo port. The adaptive IR input circuit supports 38 KHz carrier frequencies.
- L.** Power connector: Use the supplied power cord to connect power.



## MOUNTING THE AMPLIFIER

### Package contents

- EA-MINI-5.1D-200
- IEC power cable (1)
- Optical adapter (1)
- Feet (4)
- Bracing foot, rack-mount ears, and screws
- VersaBox mounting screws (4)
- Phoenix-style speaker connectors
- Bluetooth antenna

### Mounting in a rack

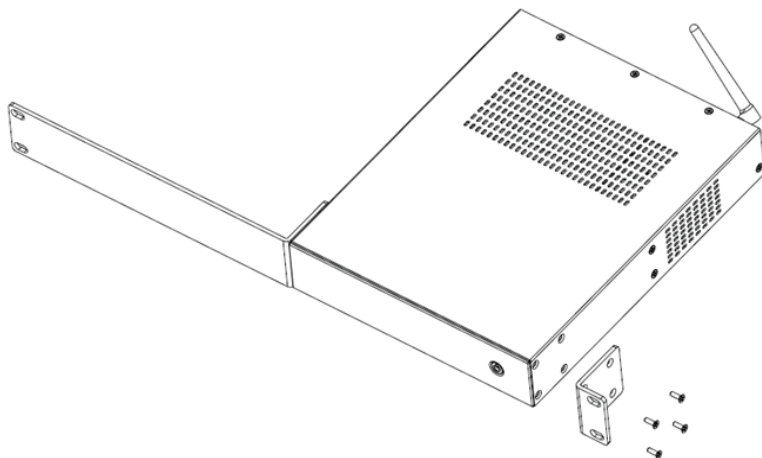

**CAUTION!** To prevent damage, maintain adequate ventilation space to the sides of the amplifier. Amplifier can be stacked vertically, but be sure to not place the amplifier next to other components or against the side of a cabinet. Doing so will block ventilation openings.



## Mounting in a Strong VersaBox

Using the provided screws, attach the amplifier to the VersaBox plate at the circled mount points. (14x14" VersaBox shown)

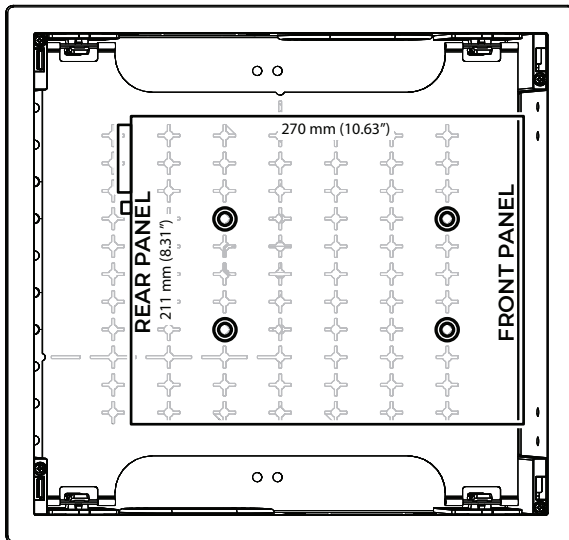

## CONNECTING NETWORK AND POWER

This device is designed to operate as part of the home system, which requires physical audio connections and connections in Composer Pro to function as designed. This section describes how to set up the physical connections required for the amplifier and some devices associated with it.

**WARNING!** Connecting speaker wires or input cables while the amplifier is powered may cause electrical shock and could damage the amplifier. Unplug the amplifier and some of the devices associated with it.

To connect the amplifier to NETWORK and power ports:

1. Connect an Ethernet Cat 5e/6 cable from a local network connection into the RJ45 port.
2. Connect the provided power cable to the amplifier's power input and to a power outlet.
3. When the power cable is first connected, the amplifier initially turns on in Standby mode. Press the front-panel power button to fully power up.



## CONNECTING TO TV

### HDMI (recommended)

1. Connect an HDMI cable from the **HDMI OUT (ARC)** output on the back of the amplifier to the **HDMI IN (ARC)** input on your TV.

#### Notes:

- An HDMI connection supports digital audio and video with a single connector. It is the best option for connecting your amplifier.
- If your TV features an HDMI ARC connector, you can enjoy the TV audio through your amplifier by using a single HDMI cable.
- An HDMI connection is required if you intend to connect additional source devices to the amplifier's AVR inputs to display them on your TV.
- If you want to enable HDMI CEC, you must do so on both your TV (using the TV's user interface) and on the Mini-5.1 AVR (using the browser user interface). HDMI CEC (consumer electronics control) is a feature that allows compatible devices to be controlled from a single remote control. For details, refer to your TV's instruction manual.

### Optical digital input

1. Connect the **OPTICAL IN** connector of the amplifier to the **OPTICAL OUT** connector of your TV with an optical cable.
2. Enable **Use Optical** through the browser user interface.

#### Notes:

- Make sure the protective cap has been removed from both ends of the optical cable.
- Make sure you have connected one optical adapter *before* inserting into the amplifier.

## CONNECTING TO OTHER DEVICES

### HDMI (recommended)

To connect other audio/video sources such as a satellite receiver, DVD player, and game console, we recommend you connect them using HDMI to one of the 3 HDMI inputs of the amplifier.

1. Connect one of the 3 **HDMI IN** on the back of the amplifier to the **HDMI OUT** output on your audio/video source using an HDMI cable.

#### Note:

- We strongly recommend you connect other audio/video sources directly to the amplifier, and **not** directly to the TV. This is the best way to ensure the best possible multichannel audio format / audio signal is reproduced accurately for each source.



## Optical digital input

1. Connect the **OPTICAL IN** connector of the amplifier to the **OPTICAL OUT** connector of your audio/video source with an optical cable.
2. Enable **Use Optical** through the browser user interface.

### Notes:

- Make sure the protective cap has been removed from both ends of the optical cable.
- Make sure you have connected one optical adapter *before* inserting into the amplifier.

## Connecting with Bluetooth

You can conveniently connect the amplifier to your mobile device wirelessly with Bluetooth.

To establish a Bluetooth® connection:

1. Make sure the included Bluetooth antenna is installed on the back of the amplifier.
2. Enable the input (Bluetooth) through the browser user interface.
3. Start the search on your mobile device.
4. Select **EA-MINI-5.1D-200** as the playback device. After confirmation, the connection is established automatically.
5. Start a title on your mobile device, and the sound should automatically output through the amplifier.

## Connecting with AUX

1. Connect a 3.5 mm stereo cable from the **AUX** port on the back of the amplifier and the line out on your mobile device. Or, connect a 3.5 mm-to-RCA stereo cable to the unbalanced output port of any audio/video source.
2. Disable **Use Optical** through the browser user interface.



## CONNECTING SPEAKERS

A ten-position screw-down plug-in connector is supplied for making connections to any of the five supported speakers. The diagram below shows how to make connections.

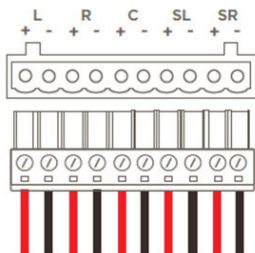

**Caution:** Observe correct polarity when making speaker connections.

When connecting wires to the 10-position screw-down connector, follow the guidelines below to ensure a safe and secure connection.

1. With a small slotted screwdriver, turn the screws on the connector counterclockwise until the silver crimp opens enough to slide wire(s) into the square slots.

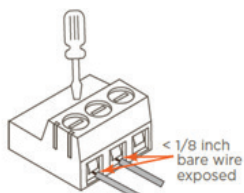

There should be no more than 1/8 inch of bare wire exposed from rear of connector.

2. Strip insulation from the wire so about 3 mm (1/8 inch) of bare wire is exposed.
3. Insert the stripped wire into the proper connection, and turn screws clockwise until the crimps tighten around each wire. Lightly tug on each wire to ensure a secure connection.

### Tips:

- #16 AWG is recommended for lengths up to 15 meters (about 50 feet).
- #14 AWG is recommended if wire length is longer than 15 meters (about 50 feet) but less than 30 meters (about 100 feet).
- #12 AWG is recommended if wire length is longer than 30 meters (about 100 feet) but less than 90 meters (about 300 feet).



## LFE output

The LFE (low-frequency effects) port accepts a standard RCA cable and connects to the **LFE** input on a subwoofer speaker.

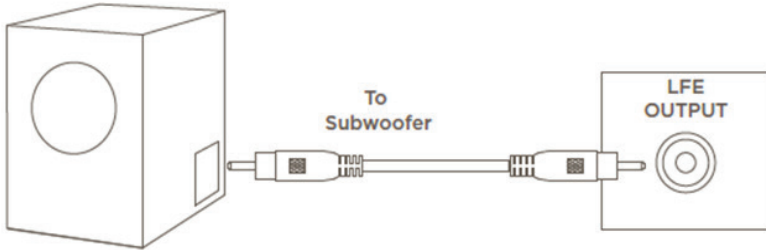

## USING THE BROWSER INTERFACE

1. Connect an Ethernet Cat 5e/6 cable from a local network connection into the RJ45 port on the amplifier.
2. Power on the amplifier.
3. In a web browser on the same local network, enter the amplifier's IP address that was assigned by the router (such as 192.168.1.2). The login screen opens.
4. Enter the default user name ("episode") and the default (first-time only) password "episode". The amplifier's configuration screen opens.

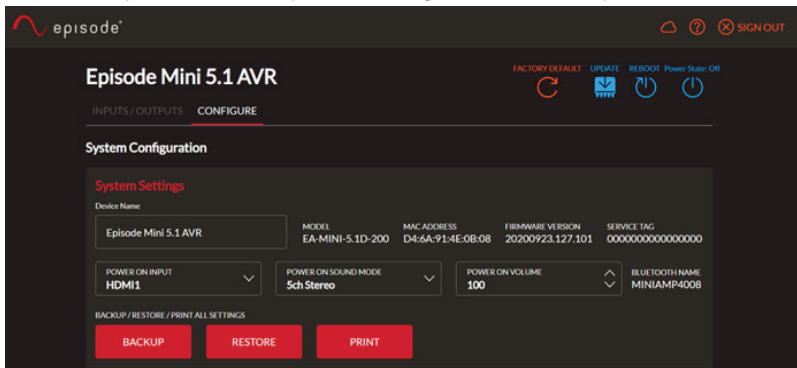

**Note:** The first time you access the interface, or after a reset to factory default settings, you must change the password.



## Basic operation

1. Set the volume gain for different input through level trim bar.

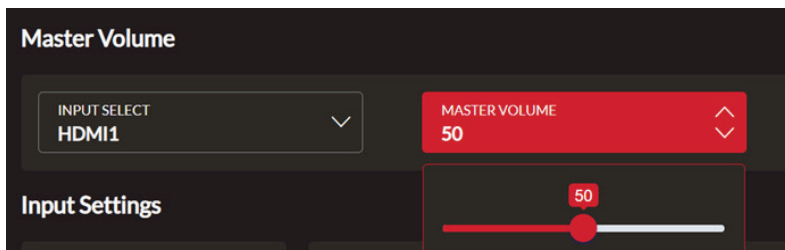

2. Select the sound mode for current input:  
**Note:** Sound mode selection applies only to audio content that is not Dolby/DTS. If the amplifier receives a Dolby/DTS signal, it will decode and output Dolby/DTS.
  - 2ch Stereo: Stereo only via front left/right and subwoofer
  - 5ch Stereo: Stereo via all channels (upmix)
  - Dolby PLII Music: Dolby ProLogic II for music
  - Dolby PLII Movie: Dolby ProLogic II for movies

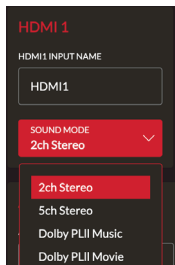





## Main functions

1. Adjust the Speaker Setup parameters for each channel, including speaker size, crossover, slope, speaker level, and test tone.

Front Left	Center	Front Right
SPEAKER SIZE Large	SPEAKER SIZE Large	SPEAKER SIZE Large
CROSSOVER Full	CROSSOVER Full	CROSSOVER Full
SLOPE 6	SLOPE 6	SLOPE 6
SPEAKER LEVEL 0	SPEAKER LEVEL 0	SPEAKER LEVEL 0
DISTANCE (FEET) 3.39	DISTANCE (FEET) 3.39	DISTANCE (FEET) 3.39
DISTANCE (METERS) 1.01	DISTANCE (METERS) 1.01	DISTANCE (METERS) 1.01

- **Speaker size:** You can set the size of the speakers according to your speaker system. **Large** and **Small** are the two options for the Front Left, Center, Front Right, Surround Left, and Surround Right speakers. **On** and **Off** are the two options for the Subwoofer output.
- **Crossover:** With the crossover frequency, you define the frequency up to which the subwoofer should be active.
- **Slope:** With the slope setting, you can set the frequency rolloff (steepness) of the crossover filters. Options include **6**, **12**, and **24** dB per octave. Lower values result in a more gradual rolloff, and higher values result in a more aggressive rolloff.
- **Speaker Level:** Set the relative volume within a range from -10 (decrease) to +10 (increase) for each speaker.
- **Distance:** Speakers are usually located at different distances from the listening position, which may compromise the surround sound effect. Here, you can set a slight delay of the signal to compensate these differences for all channels. Measure the distance from the listening position to the speakers and enter these values in the menu. The system calculates the required delays to each channel.
- **Test signal:** You can activate and deactivate pink noise as a neutral test sound.

## Configuring the default power on settings

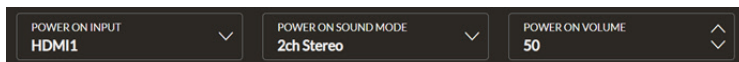

- **Power On Input:** Determines which input is selected automatically when the amplifier is turned on.
- **Power On Sound Mode:** Determines which sound mode is selected when the amplifier is turned on.
- **Note:** Sound mode selection applies only to audio content that is not Dolby/DTS. If the amplifier receives a Dolby/DTS signal it, will decode and output Dolby/DTS.
- **Power On Volume:** Determines the volume level of the amplifier when it is turned on.

## Configuring the CEC settings

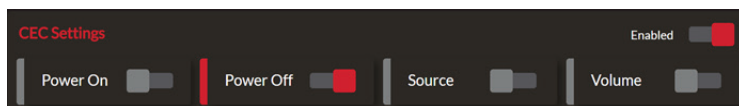

- **CEC** can be enabled or disabled on the amplifier for Power On, Power Off, Source selection, and Volume control.
- **HDMI CEC** (consumer electronics control) is a feature that allows compatible devices to be controlled from a single remote control. For details, refer to your TV's instruction manual.

## Configuring Standby mode and HDMI pass-through

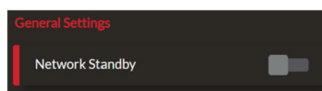
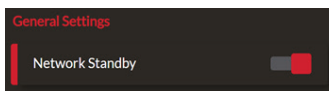

**Network Standby on:** Enables the standby feature for the amplifier.

- RJ45 port is connected: The amplifier will go to networked Standby mode without any signal input for 15 minutes.
- RJ45 port is disconnected: The amplifier will go to Standby mode without any signal input for 15 minutes.

**Network Standby off:** disables Standby for the amplifier.

**HDMI Audio Out:** Determines whether the audio signals from the connections HDMI 1, HDMI 2, and HDMI 3 are also looped through to the TV set.



## SPECIFICATIONS

General	
Power requirements	100-120V/220-240V~50/60 Hz
Power consumption	<0.4W (Standby mode) 1.3W (networked Standby mode) Max 300W (Mini 5.1 AVR)
Dimensions (L x D x W) (without feet)	270 × 211 × 44.5 mm (10.63 × 8.31 × 1.75 in.)
Weight	Without packaging: 2.25 kg (5.0 lb) With packaging: 3.6 kg (7.9 lb)
Audio	
Power output @4 ohm	3 x 50W (FL, C, FR) 2 x 25W (SL,SR)
Frequency	20 Hz to 20 KHz, ±1 dB at 1/8 power @4 ohm
Signal-to-noise ratio	>90 dB A-weighted @rated power
THD+N	<0.2% 1 KHz @rated power 4 ohm
Minimum impedance	4 ohm
Input impedance	20 kΩ @AUX input
Bluetooth	
Frequency range	2402 MHz~2480 MHz
Transmitter power	0-7 dBm
Modulation	GFSK, π/4-DQPSK, 8-DPSK
Profile	BT 3.0, A2DP v1.2, AVRCPv1.4
HDMI	
HDMI	HDMI 2.0 (with audio return channel, 3D 4K, HDR @4K30, deep color)
HDCP	HDCP 2.2

## CONTACTING TECHNICAL SUPPORT

866.838.5052

support@episodeaudio.com

## LEGAL NOTICES

### Warranty and legal information

Find details of this product's 2-Year Limited Warranty at [snapav.com/warranty](https://snapav.com/warranty), or request a paper copy from Customer Service at (866) 424-4489. Find other legal resources, such as regulatory notices, patent information, and safety information, at [snapav.com/legal](https://snapav.com/legal).

### Trademark information



Manufactured under license from Dolby Laboratories. Dolby, Dolby Audio, and the double-D symbol are trademarks of Dolby Laboratories Licensing Corporation.



For DTS patents, see <http://patents.dts.com>. Manufactured under license from DTS, Inc. (for companies headquartered in the U.S./Japan/Taiwan) or under license from DTS Licensing Limited (for all other companies). DTS, Digital Surround, and the DTS logo are registered trademarks or trademarks of DTS, Inc. in the United States and other countries. © 2020 DTS, Inc. ALL RIGHTS RESERVED.



The Bluetooth® word mark and logos are registered trademarks owned by Bluetooth SIG, Inc. and any use of such marks by SNAP AV is under license. Other trademarks and trade names are those of their respective owners.

