

Energi Savr Node™

The Energi Savr Node™ family is a group of modular products for the control of lighting loads. This document describes the following products:

- Energi Savr Node™ for 0-10 V/Switching (model QSNE-4T10-D)
- Energi Savr Node™ for Switching only (model QSNE-4S10-D)

Features

- Default configuration requires no commissioning.
- System programming accomplished manually at the unit.
- Two occupancy sensor inputs for automated control of lights in areas.
- Two daylight sensor inputs automatically adjust light levels based on the amount of natural light entering through the windows.
- Two IR receiver inputs for personal control.
- Includes QS link for seamless integration of lights, motorized window treatments, and control stations.
- Energi Savr Node™ units can be used in a Quantum® system to control and manage light in an entire building.

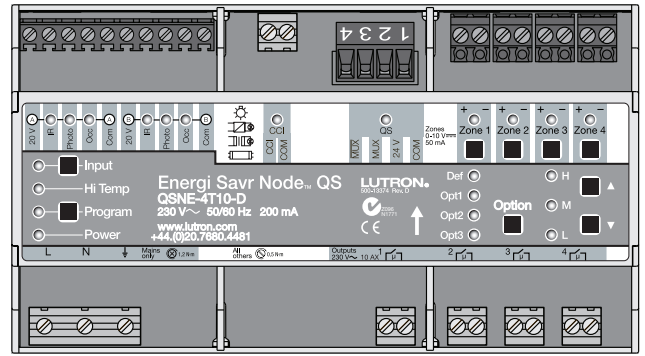

QSNE-4T10-D

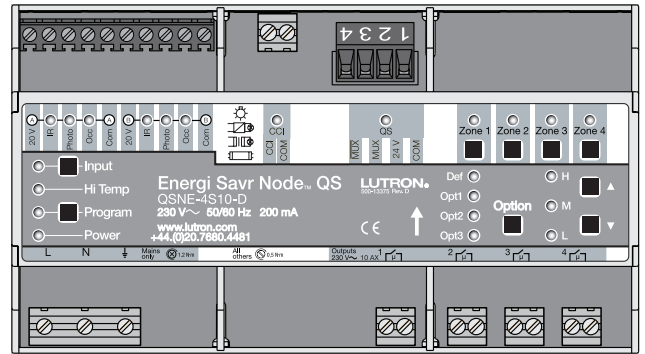

QSNE-4S10-D

System Example

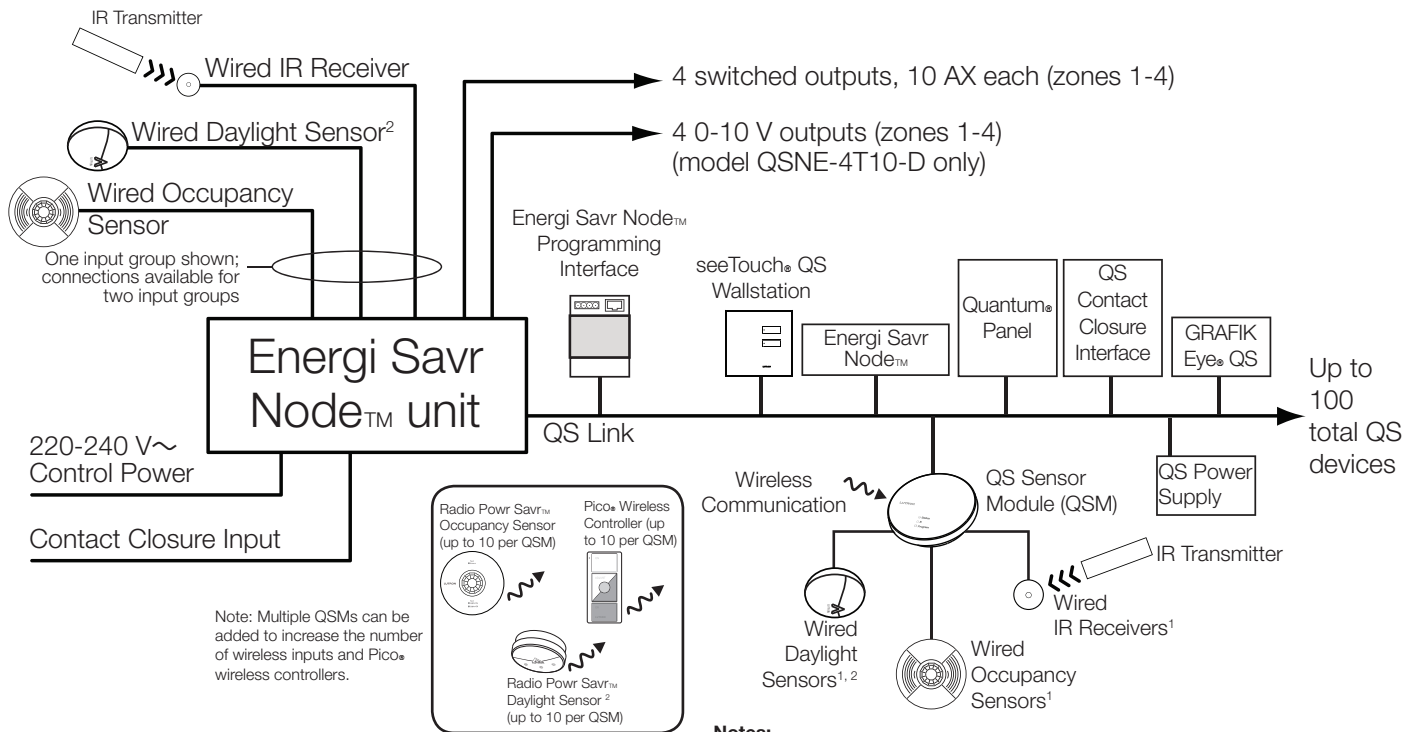

- Notes:**
- 1 Up to four wired inputs total (of any type).
 - 2 See "Daylight Sensors" in "Specifications" section for sensor count options.

Job Name:	Model Numbers:
Job Number:	

Simple Application: Preconfigured mode requires no programming

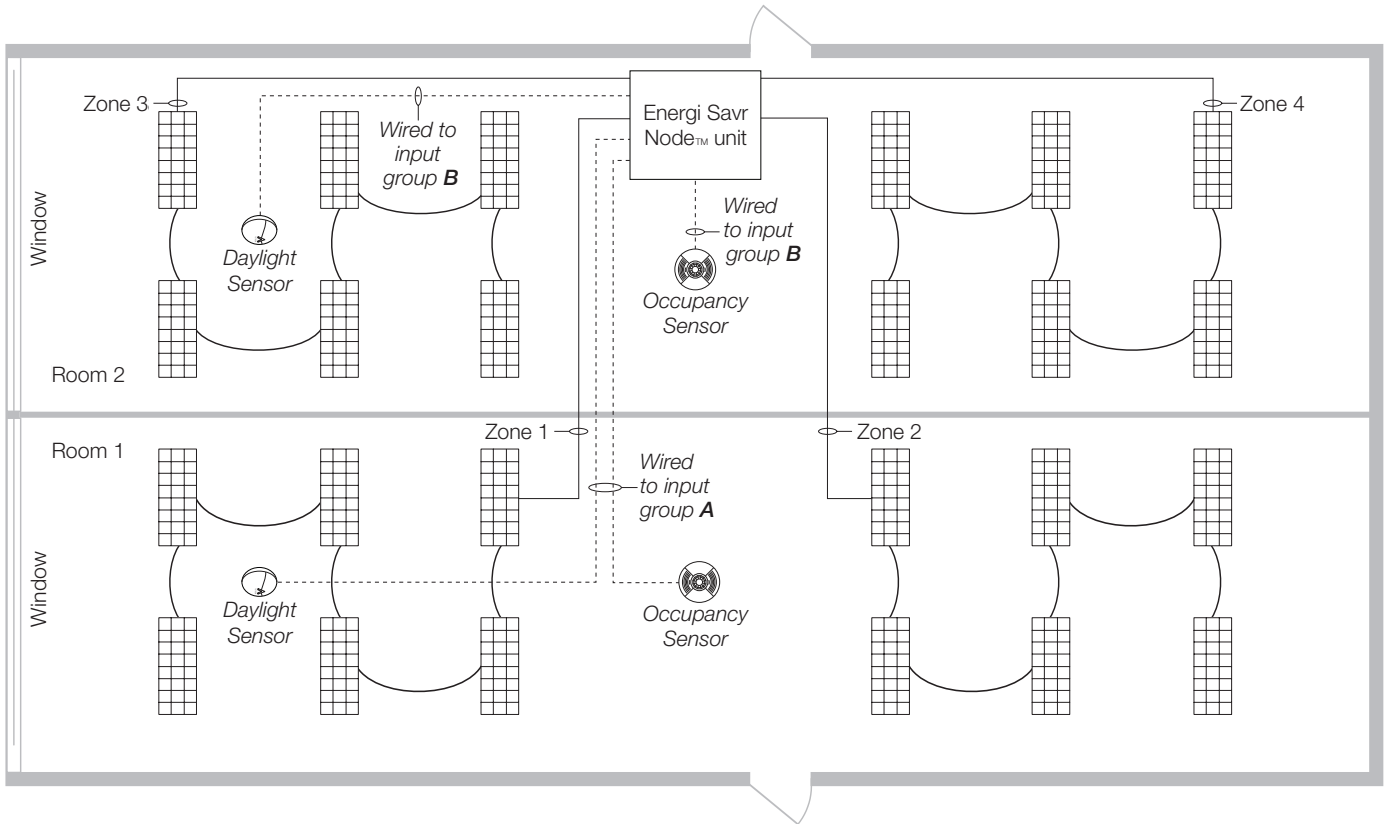

Out of Box Functionality

This section describes the default functionality that the unit will present when first installed.

Inputs (Occupancy, Daylight, and IR):

- Input group A: controls zones 1 and 2.
- Input group B: controls zones 3 and 4.

Occupancy Sensors (Occ)

- Corresponding zones will turn on to factory preset level (100%) when the occupancy sensor is in the occupied state (closed) and off when in the unoccupied state (open)

Daylight Sensors (Photo)

- When utilized in conjunction with a Lutron occupancy sensor, corresponding zones will turn on when light sensed by the daylight sensor falls below the factory preset level (if occupancy sensor indicates that area is occupied).
- QSNE-4S10-D only: Corresponding zones will turn off when light sensed by daylight sensor rises above the factory preset level.
- QSNE-4T10-D only: Corresponding zone light levels will raise or lower when light sensed by daylight sensor falls below or rises above the factory default setting.

IR Receivers (IR)

- Corresponding zones respond to On, Off, and Scene commands from compatible IR transmitters (see IR Sensor literature for compatible transmitters).
- QSNE-4T10-D only: Corresponding zones respond to raise and lower commands from compatible IR transmitters.

Job Name:	Model Numbers:
Job Number:	

Out of Box Functionality (continued)

seeTouch® QS Wallstations

- All seeTouch® QS lighting wallstations are Scene keypads by default.
- QSNE-4S10-D only: Scenes 1-16 will turn all the lights On.
- QSNE-4T10-D only: Scenes 1-16 will dim lights to the preset levels in the table below:

Scene #	Light Level: All Zones
1, 5-16	100%
2	75%
3	50%
4	25%

- Scene Off will turn all the lights Off.

Contact Closure Input (CCI)

- The CCI behaves as an Emergency Contact Closure Input.
- If the CCI is open, the Energı Savr Node™ unit will enter Emergency Mode, which will turn on all loads and disable local zone control and control from sensors and QS devices.
- When the CCI is closed or jumpered, Energı Savr Node™ unit zones will return to the settings or levels they were at prior to entering Emergency Mode.

Normal Mode Operation

- Zone and raise/lower buttons on the unit can be used to:
 - turn loads on and off (QSNE-4S10-D and QSNE-4T10-D)
 - dim loads up and down (QSNE-4T10-D only).
- Sensor status LEDs ('Occ', 'Photo', and 'IR') verify connections to control stations and sensors.

Job Name:	Model Numbers:
Job Number:	

Specifications

Power

- 230 V~ 50/60 Hz
- Lightning strike protection meets ANSI/IEEE standard 62.31-1980. Can withstand voltage surges of up to 6 000 V~ and current surges of up to 3 000 A.
- Current draw: 200 mA max

Standards

- IEC/EN 60669-2-1, EN50428
- Lutron Quality Systems registered to ISO 9001.2008

Environment

- Ambient Temperature Operating Range (inside mounting panel): 0 °C to 40 °C
- Calibration point maximum: 65 °C
- Relative humidity: less than 90% non-condensing
- For indoor use only

Terminals

- Mains Wiring: 1,0 mm² to 4,0 mm²
- 0-10 V Wiring: 0,5 mm² to 2,5 mm²
- Input Wiring: 0,5 mm² to 2,5 mm²
- CCI Wiring: 0,5 mm² to 4,0 mm²
- Zone Wiring: 1,0 mm² to 4,0 mm²
- QS Link Wiring: 0,5 mm² to 4,0 mm²

Mounting

- Use an IP20 (minimum) rated consumer panel or breaker panel with integrated DIN rail
- Width = 9 modules (161,7 mm)

Output Zone Ratings

- Each zone is rated at 10 AX for switching. Rated for resistive, inductive, or capacitive loads as defined by IEC/EN 60669-2-1.
- Switched outputs utilize latching relays to maintain relay state if control power is lost.
- 0-10 V rated for 50 mA maximum output, source or sink per zone.

QS Link Limits

- A QS link can have up to 100 zones (outputs) and 100 devices.
- Each Energi Savr Node™ (QSNE-4S10-D and QSNE-4T10-D) unit can supply 14 power draw units.
- QS Link output 24 V=== 462 mA maximum

QS link sensor limits:

- 100 wired or wireless occupancy sensors.
- 100 wired or wireless daylight sensors.
- 100 wired wallstations or Pico® wireless controllers.

For more information on Power Draw Units refer to "Power Draw Units on the QS Link" document, Lutron part number 369405.

Sensors Connected to the Energi Savr Node™ Unit

- Power Supply Outputs (2)
 - 20 V=== 50 mA maximum.
 - An auxiliary power supply must be used if the device requires more than 50 mA.

Occupancy Sensors

- Up to 16 occupancy sensors can be programmed to the Energi Savr Node™.
- Manual Programming: up to 4 occupancy sensors wired directly to the Energi Savr Node™, up to 4 occupancy sensors wired to a QS Sensor Module (QSM), and up to 10 wireless occupancy sensors through the same QSM; the total programmed to the Energi Savr Node™ cannot exceed 16.
- HHD (*Apple iPhone/iPod touch*) Programming: up to 16 occupancy sensors from any source (wired directly to the Energi Savr Node™, wired to any other Energi Savr Node™, or wired/wireless from any QSM on the QS link); the total programmed to the Energi Savr Node™ cannot exceed 16.
- Use Lutron occupancy sensors to control one or more zones.
- Use Lutron occupancy sensors in vacancy mode to automatically turn the lights off in an area after it becomes vacant.
- Each zone can be programmed to automatically turn the lights on when occupied and turn the lights off when vacant.
- Each Energi Savr Node™ wired occupancy input can power one Lutron occupancy sensor.
- Each occupied scene and unoccupied scene can be programmed independently.

Apple, iPhone, and iPod touch are trademarks of Apple Inc., registered in the U.S. and other countries.

Job Name:	Model Numbers:
Job Number:	

Sensors Connected to the Energı Savr Node™ Unit (continued)

Occupancy Sensors (continued)

- Occupancy sensor must provide a dry contact closure or solid-state output.
- Additional occupancy sensors can be used with the Energı Savr Node™ unit. Refer to the “Programming Options and Features” table for system rules.

Infrared (IR) Receivers

- Use Lutron IR receivers and compatible transmitters for personal control of individual lighting zones.
- Two IR receivers can connect directly to the Energı Savr Node™ unit.
- Additional infrared receivers can be used with the Energı Savr Node™ unit. Refer to the “Programming Options and Features” table for system rules.

Daylight Sensors

- Lutron daylight sensors allow daylight harvesting with programmable effect on light output.
- Two daylight sensors can be connected directly to the Energı Savr Node™ unit.
- Use Lutron EC-DIR-WH sensors to control one or more zones.
- Additional daylight sensors can be used with the Energı Savr Node™ unit. Refer to the “Programming Options and Features” table for system rules.

Communication with GRAFIK Eye® QS

- Energı Savr Node™ unit zones can be configured to respond to GRAFIK Eye® QS scene buttons.
- Energı Savr Node™ unit zones can be configured to respond to scene commands initiated by the GRAFIK Eye® QS astronomic time clock.
- Energı Savr Node™ unit operates in afterhours mode when associated with a GRAFIK Eye® QS that is in afterhours mode.

Communication with QSE-IO

- Energı Savr Node™ unit zones can be configured to respond to scene commands initiated by the QSE-IO in scene selection mode.
- Energı Savr Node™ unit can be configured to respond to zone toggle or occupancy sensor commands initiated by the QSE-IO in zone toggle mode or occupancy sensor mode.

Communication with QSE-CI-NWK-E

- Integrate Energı Savr Node™ units with touchscreens, PCs, A/V systems or other digital systems and devices.

Job Name: Job Number:	Model Numbers:
--	-----------------------

QSM (QS Sensor Module) - Integrating Wired and Wireless Sensors

- Use the QSM to integrate Radio Powr Savr™ Occupancy/Vacancy sensors, Radio Powr Savr™ Daylight sensors, and Pico® Wireless Controllers to control zones on the Energı Savr Node™ unit.
- Assign up to 10 Radio Powr Savr™ Occupancy/Vacancy sensors.
- Assign up to 10 Radio Powr Savr™ Daylight sensors.
- Assign up to 10 Pico® Wireless Controllers.
- Add additional wired and wireless inputs by adding QS Sensor Modules to the QS link.
- Refer to the “Programming Options and Features” table for QSM and wireless sensor system rules.
- Only one QSM per Energı Savr Node™ unit with manual programming.
- Multiple QSMs per Energı Savr Node™ unit with *Apple iPod touch* or *iPhone* programming (requires QSE-CI AP-D and WiFi router). See “Programming Options” for details.
- Wire and power up to 4 wired inputs (of any type) total to the QSM
 - Daylight sensors
 - Occupancy sensors
 - Infrared (IR) receivers
- The Radio Powr Savr™ sensors and Pico® Wireless Controllers associated with the QSM should be mounted within 18 m line of sight, or 9 m through walls, of the QSM.
- Refer to QSM Specification Submittal for more information.

seeTouch® QS Controls

- seeTouch® QS wallstations can be configured to control Energı Savr Node™ unit scenes or zones.
- In zone toggle mode, zone buttons can be assigned to one or more zones on any Energı Savr Node™ unit connected to the QS link to toggle zones between Off and a Preset level.
- In scene mode, wallstations can be assigned to zones on one or more Energı Savr Node™ units connected to the QS link to activate saved scenes.
- Select one of 16 scenes and off in Energı Savr Node™ unit.
- Control individual lighting zones.
- LED indicator displays scene or zone status.

Apple, iPhone, and iPod touch are trademarks of Apple Inc., registered in the U.S. and other countries.

Job Name:	Model Numbers:
Job Number:	

Programming Options and Features

	Manual Programming	HHD Programming: <ul style="list-style-type: none"> • Requires ESN Programming Interface QSE-CI-AP-D • Requires <i>Apple iPod touch</i> or <i>iPhone</i> mobile digital device
Energi Savr Node™ units (ESNs) Connected to QS Link	Not more than 1	Multiple—100 QS devices and 100 zone limits apply
QS Sensor Modules (QSMs) Connected to QS link	Not more than 1	Multiple—100 QS devices limit applies

Wired Occupancy Sensors

System Limits	2 connected directly to ESN unit Up to 4 wired to QSM	Up to 100 total occupancy sensors per QS link (wired + wireless)
Can be assigned to...	Any zone(s) on the ESN unit	Zones on ESN unit or share to other ESN units on same QS link
Occupancy Dependency and Grouping Supported	No	Yes

Wireless Occupancy Sensors

System Limits	Associate 10 occupancy sensors to QSM to control zones on the ESN unit	Up to 100 total occupancy sensors per QS link (wired + wireless)
Can be assigned to...	Any zone(s) on the ESN unit	Zones on ESN unit or share to other ESN units on same QS link
Occupancy Dependency and Grouping Supported	No	Yes

Apple, iPhone, and iPod touch are trademarks of Apple Inc., registered in the U.S. and other countries.

Job Name:	Model Numbers:
Job Number:	

Programming Options and Features (continued)

Manual Programming

HHD Programming:

- Requires ESN Programming Interface QSE-CI-AP-D
- Requires *Apple iPod touch* or *iPhone* mobile digital device

Wired Daylight Sensors

System Limits	Maximum of 1 daylight sensor per zone 2 connect directly to the ESN unit Additional daylight sensors can connect to the QSM	Maximum of 2 daylight sensors per zone Up to 100 total daylight sensors per QS link (wired + wireless)
Can be assigned to...	Any zone(s) on the ESN unit	Zones on ESN unit or share to other ESN units on same QS link
Disable daylighting in Scenes	No	Yes

Wireless Daylight Sensors

System Limits	Maximum of 1 daylight sensor per zone Associate wireless daylight sensors to the QSM	Maximum of 2 daylight sensors per zone Associate up to 10 wireless daylight sensors per QSM Up to 100 total daylight sensors per QS link (wired + wireless)
Can be assigned to...	Any zone(s) on the ESN unit	Zones on ESN unit or share to other ESN units on same QS link
Disable daylighting in Scenes	No	Yes

Pico® Wireless Controllers

Can be assigned to...	Any zone on the local ESN unit	Any number of zones or areas on ESN units on same QS link
-----------------------	--------------------------------	---

IR Receivers and Wallstations

System Limits	2 connect directly to the ESN unit Up to 4 wired to the QSM	Up to 100 total controls per QS link (wired wallstations, IR receivers)
Can be assigned to...	Any zone on the local ESN unit	Zones on ESN unit or share to other ESN units on same QS link

Emergency Contact Closure Input

Can be assigned to...	Any zone(s) on the ESN unit	Any or all local ESN unit zones
Emergency Light level	Configurable	Configurable

Apple, iPhone, and iPod touch are trademarks of Apple Inc., registered in the U.S. and other countries.

Job Name:	Model Numbers:
Job Number:	

Programming Options and Features (continued)

Manual Programming

HHD Programming:

- Requires ESN Programming Interface QSE-CI-AP-D
- Requires *Apple iPod touch* or *iPhone* mobile digital device

seeTouch® QS wallstations

Scene Keypads assigned to...	Any zone(s) on the ESN unit	Any zone(s) on one or more ESN units on the QS link
Scene + off keypads assigned to...	Any zone(s) on the ESN unit	Any zone(s) on one or more ESN units on the QS link
Zone toggle keypad buttons assigned to...	Any zone(s) on the ESN unit	Any zone(s) on one or more ESN units on the QS link
Change Keypad to Scene or Zone	Yes	Yes
Changing keypads to shade, panic, fine tune	No	Yes

Zone Configuration Parameters

Load type	0-10, 10-0, or switched	0-10, 10-0, or switched
High-end trim	Adjustable	Adjustable
Low-end trim	Adjustable	Adjustable
Absolute minimum level	Adjustable	Adjustable

Scenes

Available scenes	Scenes 1-16 and off	Scenes 1-16 and off
------------------	---------------------	---------------------

GRAFIK Eye® QS	Follow GRAFIK Eye® QS scenes, timeclock events, and/or afterhours events	Follow GRAFIK Eye® QS scenes, timeclock events, and/or afterhours events
-----------------------	--	--

QSE-IO	Scene, zone toggle, occupancy	Scene, zone toggle, occupancy
---------------	-------------------------------	-------------------------------

QSE-CI-NWK-E	Yes	Yes
---------------------	-----	-----

Apple, iPhone, and iPod touch are trademarks of Apple Inc., registered in the U.S. and other countries.

Job Name:	Model Numbers:
Job Number:	

Mechanical Dimensions

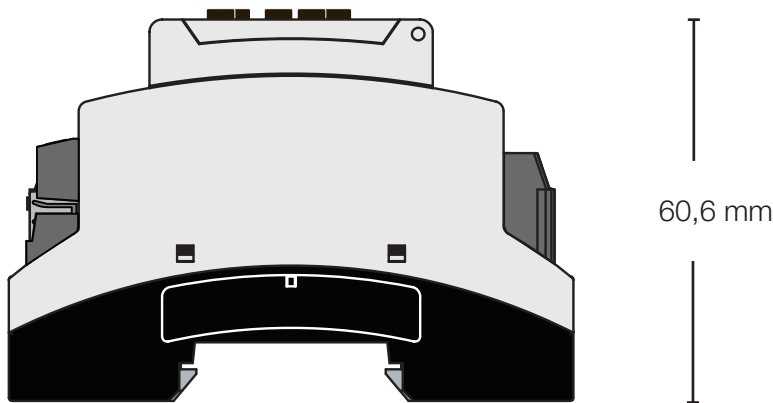
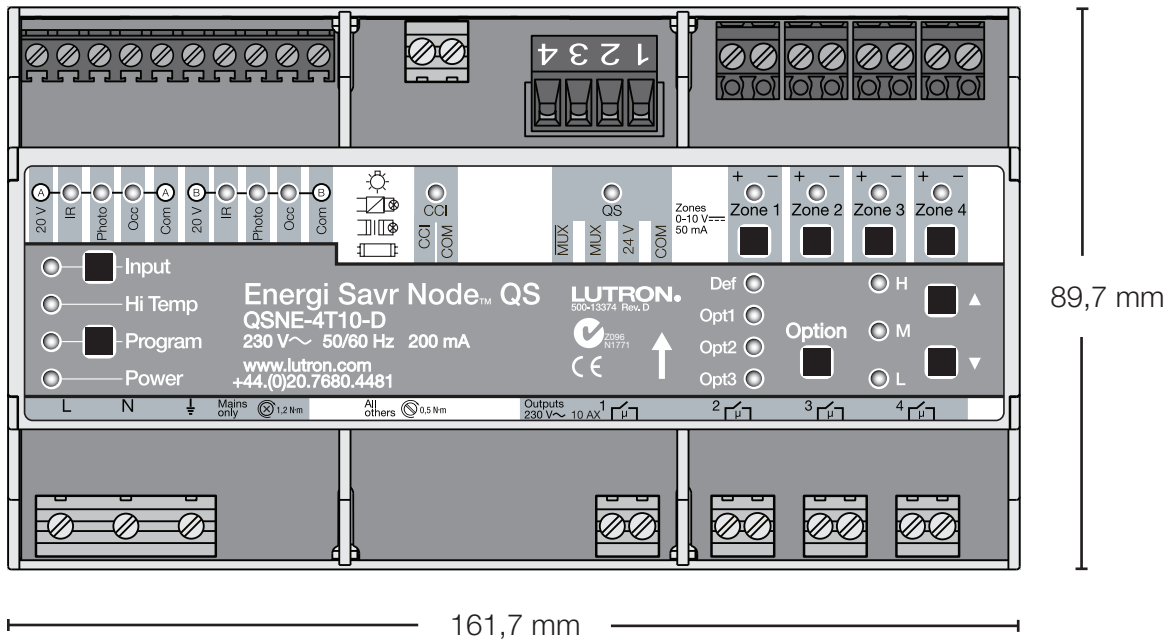

Job Name:	Model Numbers:
Job Number:	

Overview of Wiring Terminals

QSNE-4T10-D

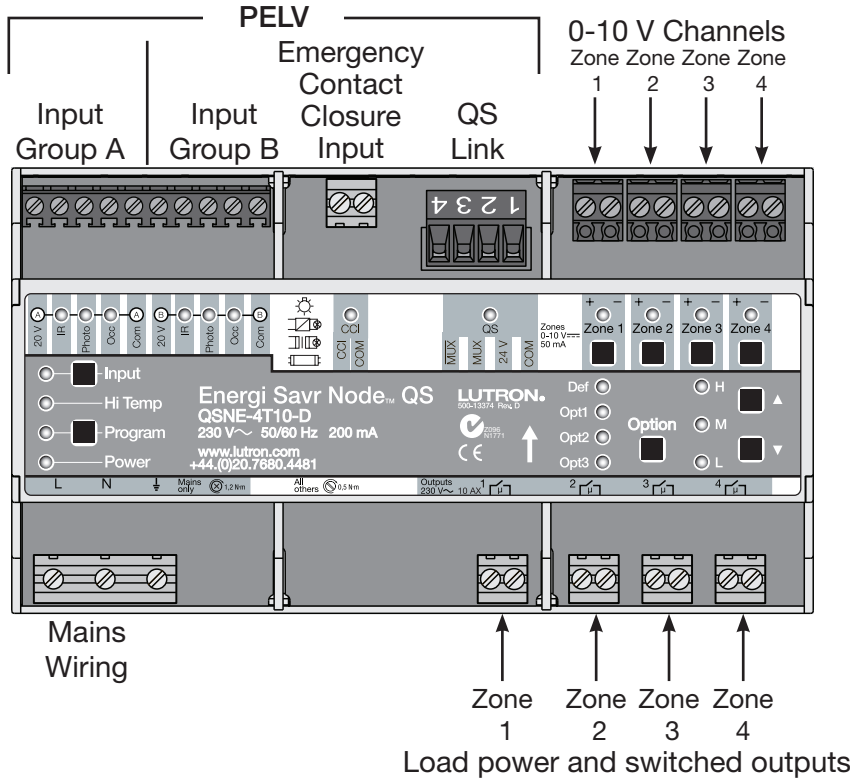

QSNE-4S10-D

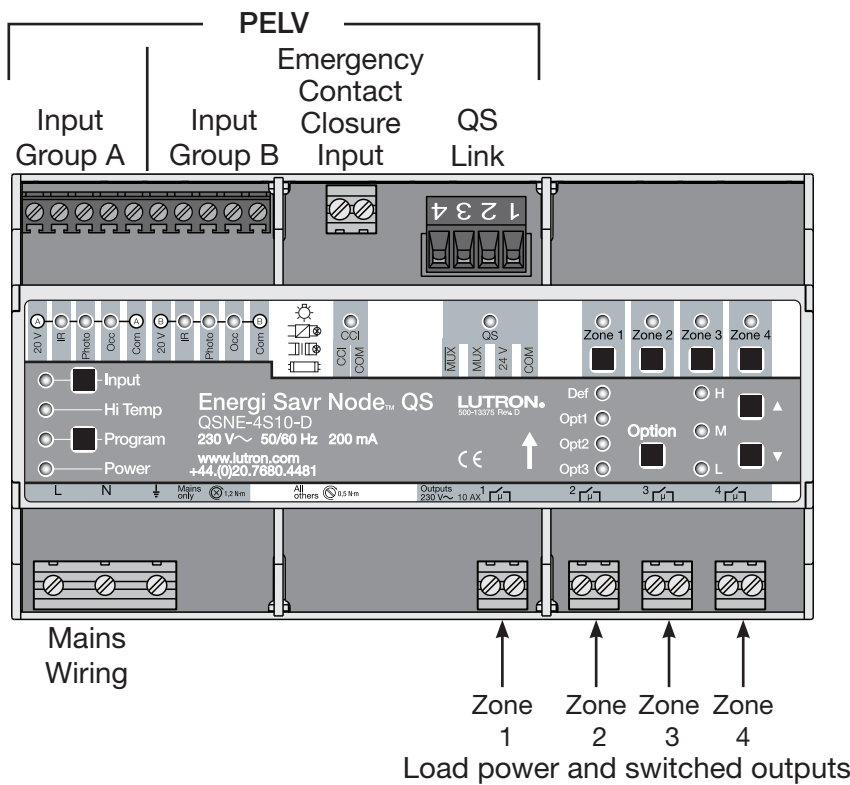

Job Name:	Model Numbers:
Job Number:	

Mains Voltage Wiring

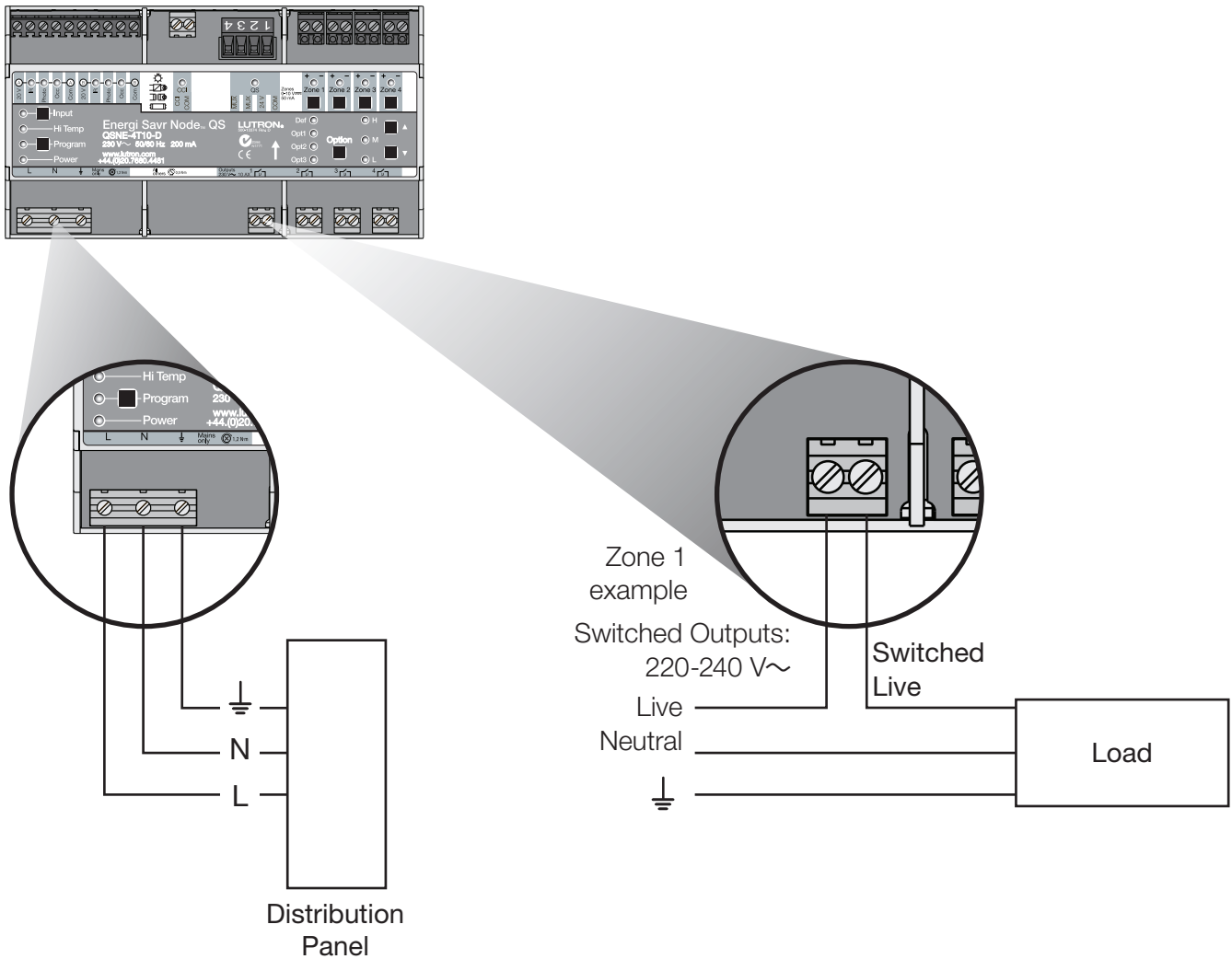

Wiring from Distribution to Energi Savr Node™ unit

- Turn off all circuit breakers or isolators feeding the Energi Savr Node™ unit at distribution panel.
- Run live, neutral, and earth (⏚) wires from a 230 V~ 50/60 Hz feed to the Energi Savr Node™ unit.

Mains Wiring and PELV Separation

- Follow appropriate local and national codes to avoid violating required separation guidelines.

Behavior During Power Failure

- Relays do not change state when power is lost to the L/N/⏚ terminals. Follow local and national codes for emergency lighting requirements.

Job Name:	Model Numbers:
Job Number:	

Wiring: 0-10 V

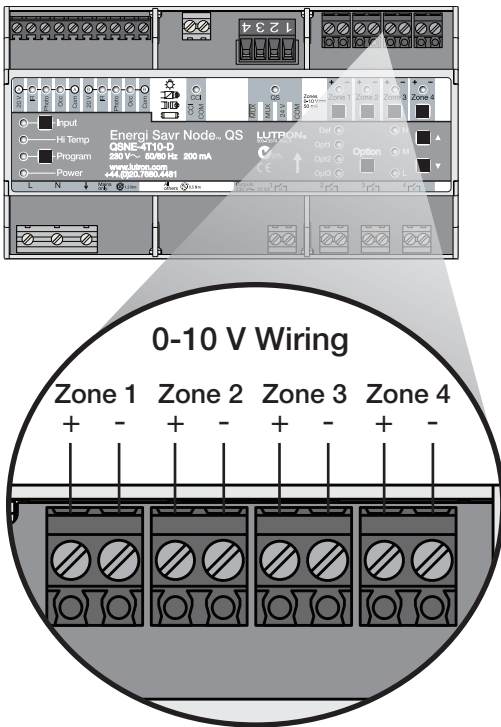

0-10 V Wiring

(QSNE-4T10-D only)

- 0-10 V zones 1-4 are double-insulated from all other inputs and outputs.
- 0-10 V zones 1-4 are not insulated from each other. They share the same common (negative “-” terminal).
- Do not mix SELV/PELV circuits and non-SELV/PELV circuits. Connect only SELV/PELV circuits, or connect only non-SELV/PELV circuits to 0-10 V zones 1-4.
- Follow all national and local electrical codes for separation requirements.

Job Name:	Model Numbers:
Job Number:	

Wiring: Emergency Contact Closure Input

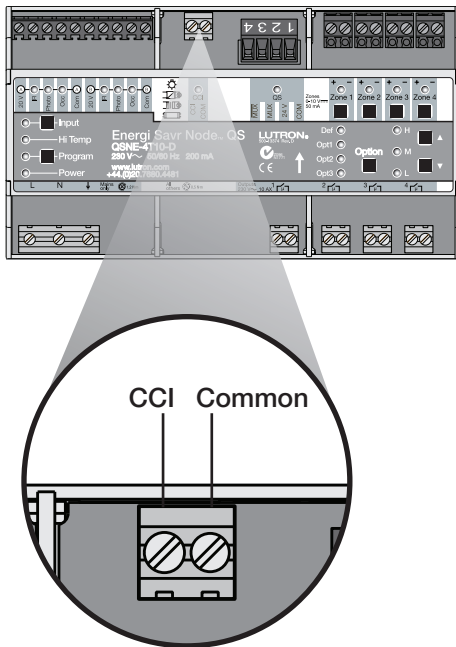

PELV Emergency Contact Closure Input

- Contact Closure Input (CCI) wiring is PELV. Follow all applicable national and local codes for proper circuit separation and protection.
- When in emergency mode, all ballasts and modules will be at their programmed emergency light level (default is 100%). Sensors and controls will not affect units in emergency mode. Sensors and controls connected to a unit in emergency mode will continue to affect units on the link that are not in emergency mode.
- Emergency contact closure input is normally closed (NC). The Energi Savr Node™ unit is shipped with a jumper pre-installed.

Note: The Energi Savr Node™ unit will default to Emergency Mode if the CCI is left open. If no Emergency contact input is required, please leave the wire jumper in the CCI terminals.

<p>Job Name:</p> <p>Job Number:</p>	<p>Model Numbers:</p>
--	-----------------------

Wiring: QS Link

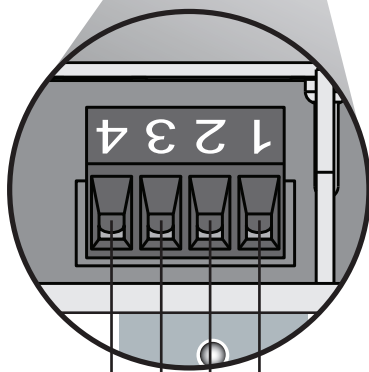
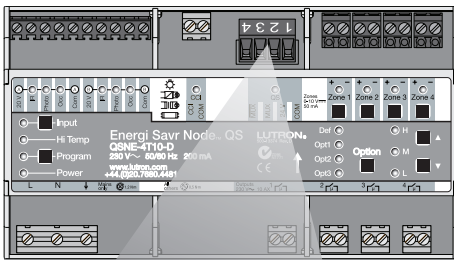

- (1) COM
- (2) 24 V_{AC}
- (3) MUX
- (4) MUX

IEC PELV QS Link Wiring

- Link communicates using PELV wiring.
- Follow all applicable national and local codes for proper circuit separation and protection.
- Wiring may be daisy chained or t-tapped.
- Total length of QS link must not exceed 600 m.
- For lengths under 150 m, use two 1,0 mm² conductors for control power (24 V_{AC}, COM).
- For lengths over 150 m, use two 4,0 mm² conductors for control power (24 V_{AC}, COM).
- Use one, twisted-shielded pair of 1,0 mm² for data link (MUX, MUX).

<p>Job Name:</p> <p>Job Number:</p>	<p>Model Numbers:</p>
--	-----------------------

Wiring: QS Link (continued)

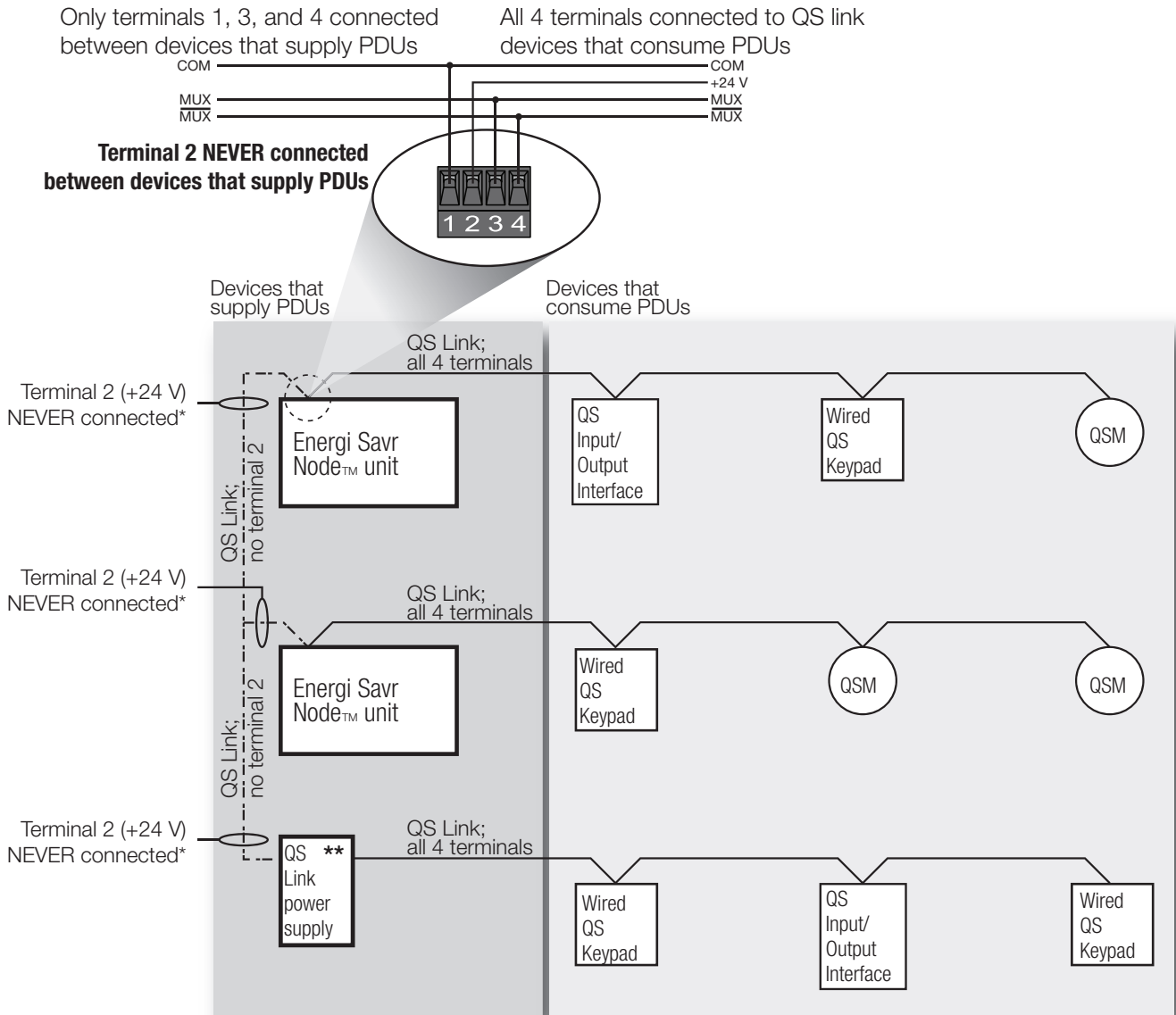

QS Link Wiring Rules

- * Terminal 2 (+24 V) should NEVER be connected between devices that supply PDUs.
- ** For QS Link power supply wiring connection details, refer to the installation instructions for the specific power supply model being used.

Job Name:	Model Numbers:
Job Number:	

Wiring: PELV Inputs

Electrical Contractors and Engineers

- All input wiring is PELV. Follow all applicable national and local codes for proper circuit separation and protection.
- Input terminals accept 1,0–2,5 mm² solid wiring.
- Mains voltage and PELV wiring must be kept separate.

Wiring Instructions:

- Turn off all breakers or isolators feeding the Energi Savr Node™ unit and its loads, at distribution panel.

Daylight Sensor:

- Connect the four conductors to the four terminals as shown.
- Terminals:
Red = 20 V White = IR
Black = Common Yellow = Daylight
- Daylight Sensor must be placed within 30 m of the Energi Savr Node™ unit.
- One daylight sensor can be wired to each input group.
- Consult the daylight sensor specification sheet to properly install sensor.
- Do not place the sensor above pendants, fixtures, directly below lighting fixtures, or within skylight wells.

Occupancy Sensor:

- Connect three conductors to three terminals as shown.
- One occupancy sensor can be wired to each input group.
- Sensor must be placed within 30 m of the Energi Savr Node™.

IR Receiver:

- Connect the three conductors to the three terminals as shown.
- Receiver must be placed within 30 m of the Energi Savr Node™.
- One IR Receiver can be wired to each input group.
- If a daylight sensor and IR receiver are connected, do not connect the daylight sensor's IR output (white wire).

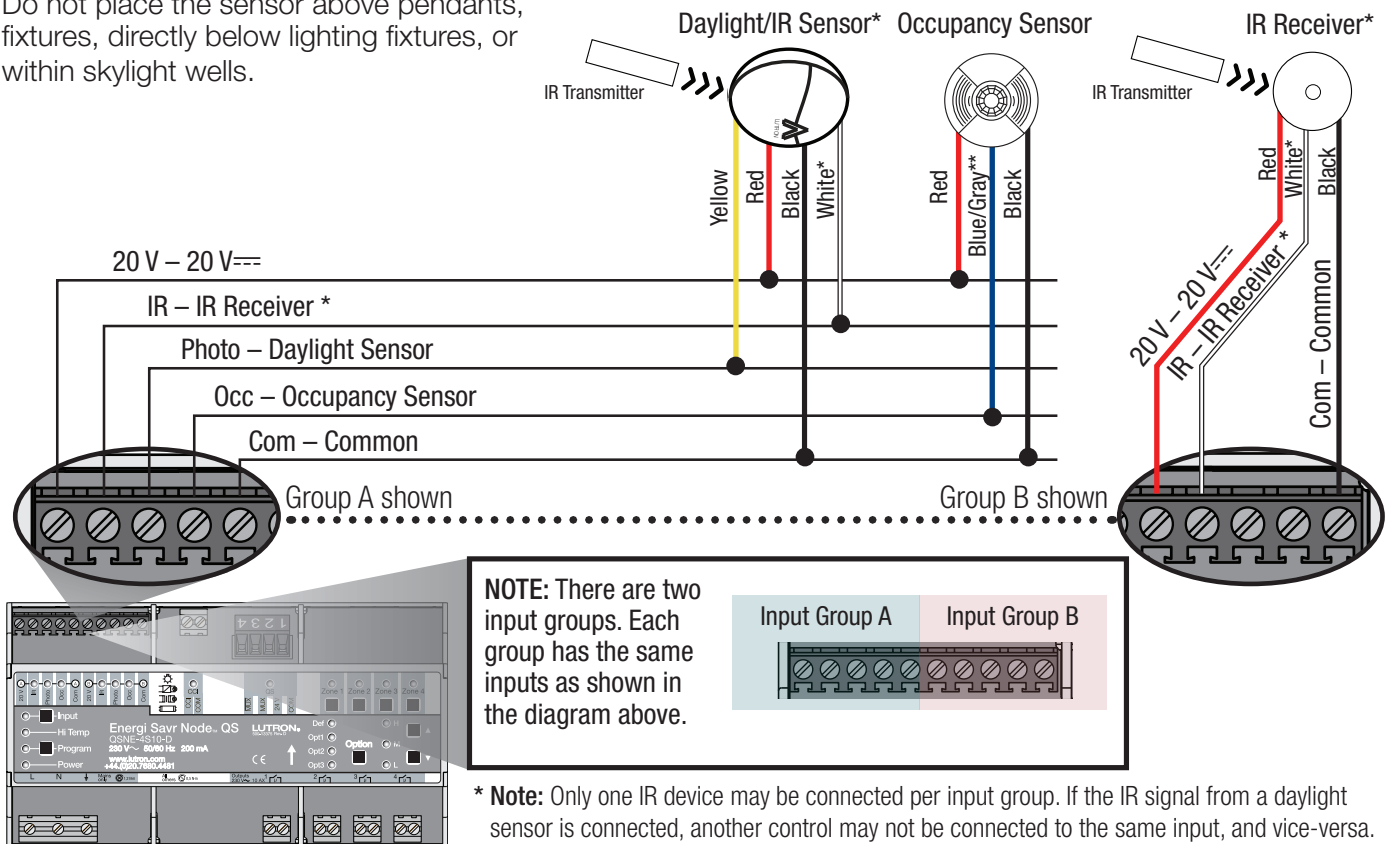

Job Name:	Model Numbers:
Job Number:	

Programming Options

Details for each option can be found in the “Programming Options and Features” table on the next page.

Manual Programming:

- Use buttons on the front of the Energi Savr Node™ unit.
- Use manual programming in installations with only one Energi Savr Node™ unit and with one QS Sensor Module (QSM) or fewer on the QS link.

HHD Programming

- Requires ESN Programming Interface (QSE-CI-AP-D).
- Requires *Apple iPod touch* or *iPhone* mobile digital device.
- Use the intuitive programming application for the *Apple iPod touch* or *iPhone* to program systems with multiple Energi Savr Node™ units and QSMs on the QS link.

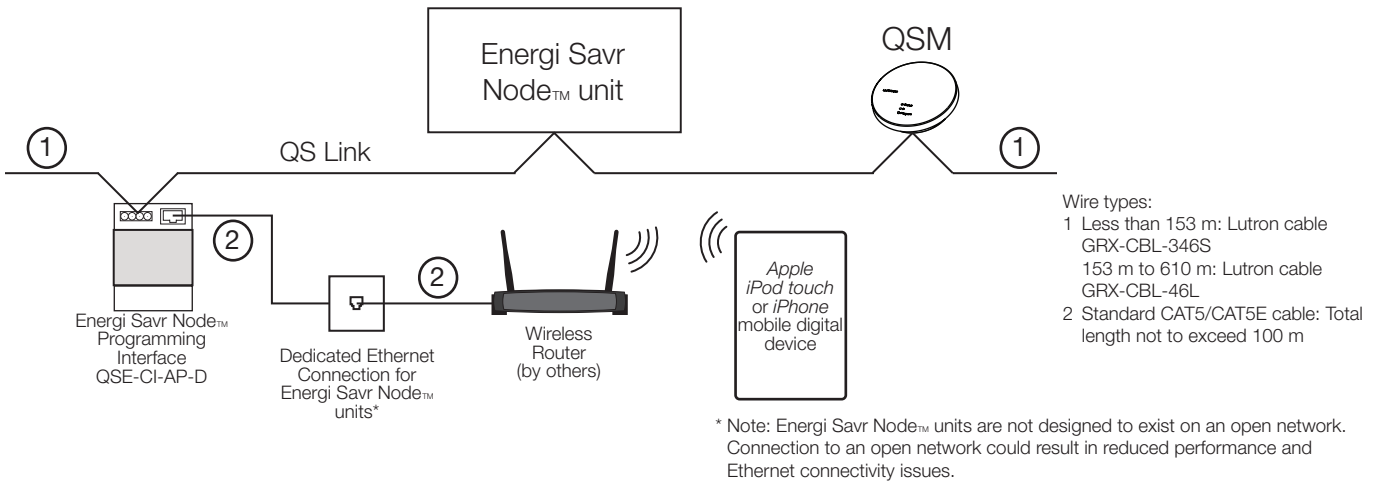

- Wireless router only required for programming with an *Apple iPod touch* or *iPhone*.
- Wireless router may be removed for normal operation.
- Ethernet connection may be made via an an Energi Savr Node™ Programming Interface (QSE-CI-AP-D) or an Energi Savr Node™ unit with integral Ethernet jack.
- Lutron recommends that an Energi Savr Node™ Programming Interface (or Energi Savr Node™ unit with Ethernet jack) be wired to an Ethernet jack in the space for ease of access and proximity to power for the wireless router.
- Works with any standard wireless router that supports multicast packets.
- *Apple iPod touch* or *iPhone* can program all Energi Savr Node™ units connected to an Energi Savr Node™ Programming Interface via the QS Link (except when part of a Quantum® system).
- Energi Savr app is required and is available from the *Apple AppStore* online marketplace.

Apple, iPhone, and iPod touch are trademarks of Apple Inc., registered in the U.S. and other countries. App Store is a service mark of Apple Inc.

Job Name:	Model Numbers:
Job Number:	